



DSA800/E Series Spectrum Analyzer

- All-Digital IF Technology
- Frequency Range from 9 kHz up to 7.5 GHz
- Min. -161 dBm Displayed Average Noise Level (Typ.)
- Min. < -98 dBc/Hz @ 10 kHz Offset Phase Noise
- Level Measurement Uncertainty < 0.8 dB
- 10 Hz Minimum Resolution Bandwidth
- Up to 7.5 GHz Tracking Generator (DSA8XX/E-TG)
- Advanced Measurement Functions (Opt.)
- EMI Filter & Quasi-Peak Detector Kit (Opt.)
- VSWR Measurement Kit (Opt.)
- PC Software (Opt.)
- Optional RF TX/RX Training Kit
- Optional RF Accessories (Cable, Adaptor, Attenuator, Bridge ...)
- Complete Connectivity: LAN (LXI), USB Host & Device, GPIB (Opt.)
- 8 Inch WVGA (800x480) Display
- Compact Size, Light Weight Design

DSA800/E Series Spectrum Analyzer



Product Dimensions: Width X Height X Depth = 361.6 mm x 178.8 mm x 128 mm

► Benefits of Rigol's all digital IF design

- The ability to measure smaller signals: on the basis of this technology, the IF filter enables smaller bandwidth settings, which greatly reduce the displayed average noise level.
- The ability to distinguish between small signals by frequency: using the IF filter with the smallest bandwidth setting, it is possible to make out signals with a frequency difference of only 10 Hz.
- High precision amplitude readings: this technology almost eliminates the errors generated by filter switching, reference level uncertainty, scale distortion, as well as errors produced in the process of switching between logarithmic and linear display of amplitude when using a traditional analog IF design.
- Higher reliability: compared with traditional analog designs, the digital IF greatly reduces the complexity of the hardware, the system instability caused by channel aging, and the temperature sensitivity that can contribute to parts failure.
- High measurement speed: the use of digital IF technology improves the bandwidth precision and selectivity of the filter, minimizing the scanning time and improving the speed of the measurement.

► Features and Benefits

Distinguish the two nearby signals clearly with the 10 Hz RBW

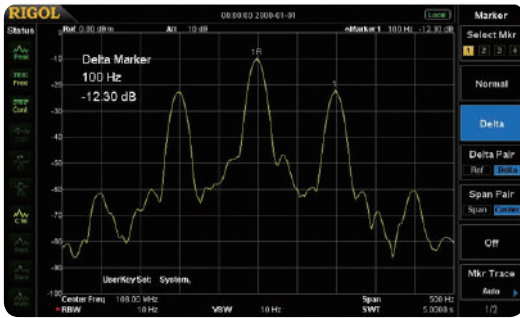

Compare the spectrums with different color trace

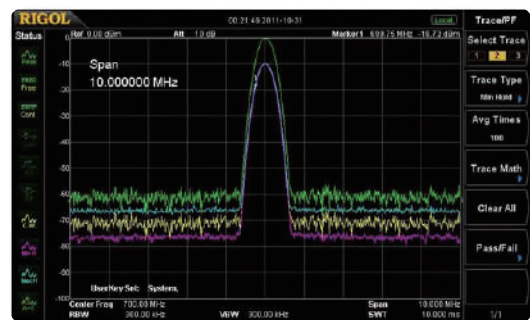

Readout the spectrum peak values with the peak table function

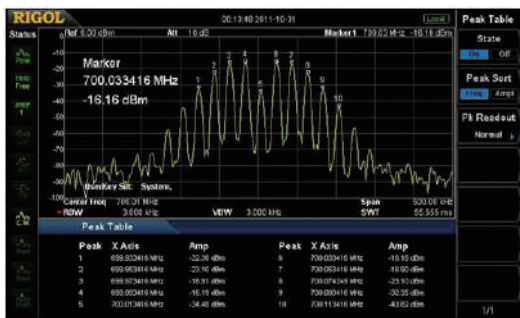

Measure lower level signal with the preamplifier turn on

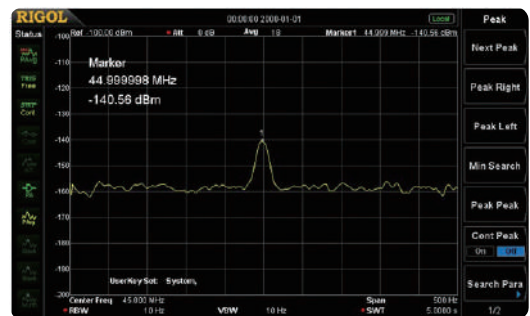

Phase noise < -98 dBc/Hz @10 kHz offset (DSA832/875/832E)

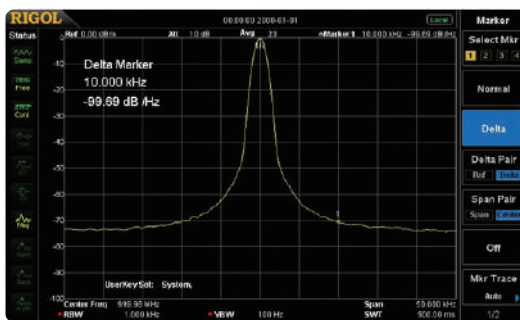

EMI kit (EMI filter & Quasi-peak & Pass/Fail)

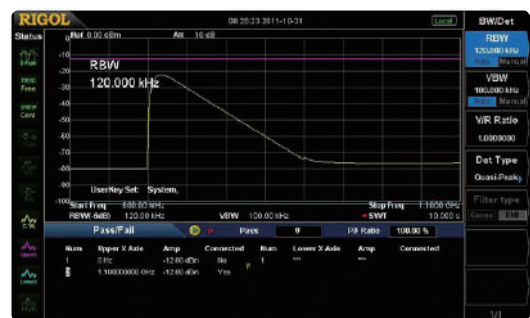

The GUI to control the RF demo kit (Transmitter) directly

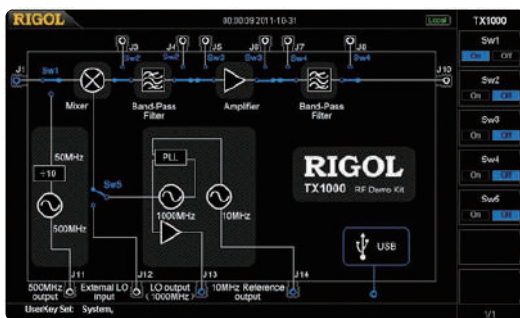

VSWR measurement

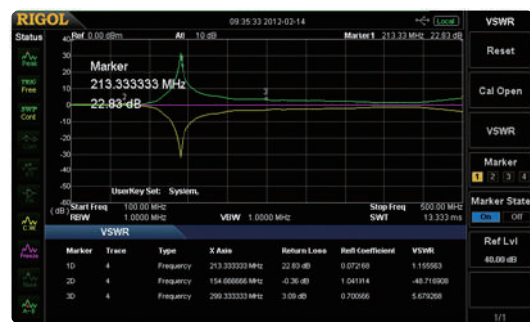

► RIGOL Spectrum Analyzer Option and Accessory

Harmonic Distortion	TOI	Emission Bandwidth
Channel Power	Occupied Bandwidth	
Time Domain Power	Carrier to Noise Ratio	
Adjacent Channel Power	Pass/Fail	

Advanced Measurement Kit
(AMK-DSA800)



USB to GPIB Converter
(USB-GPIB)

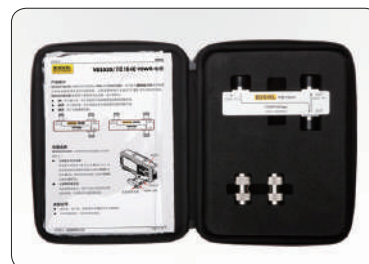

VSWR Bridge
(VB1032/VB1040/VB1080)



RF Demo Kit
(TX1000)

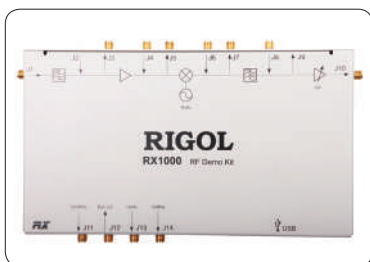

RF Demo Kit
(RX1000)



RF CATV Kit



DSA Utility Kit



RF Adaptor Kit



RF Attenuator Kit



RF Cable Kit
(CB-NM-NM-75-L-12G)
(CB-NM-SMAM-75-L-12G)



High Power Attenuator
(ATT03301H)

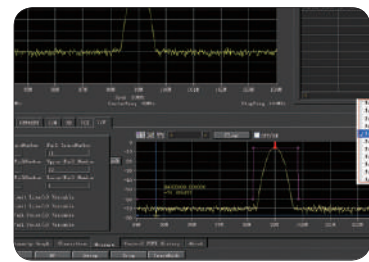

DSA PC Software
(Ultra Spectrum)

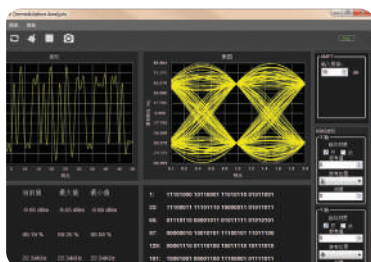

ASK-FSK Demodulation Analysis
(S1220 ASK-FSK Demodulation Analysis Software)

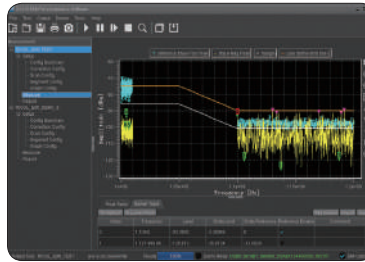

EMI Pre-compliance Test Software
(S1210 EMI Pre-compliance Software)



Near Field Probe
(NFP-3)

► Specifications

Specifications are valid under the following conditions: the instrument is within the calibration period, is stored for at least two hours at 0 °C to 50 °C temperature, and is warmed up for 40 minutes. Unless otherwise noted, the specifications in this manual include the measurement uncertainty.

Typical (typ.): characteristic performance, which 80 percent of the measurement results will meet at room temperature (approximately 25°C). This data is not warranted and does not include the measurement uncertainty.

Nominal (nom.): the expected mean or average performance or a designed attribute (such as the 50 Ω connector). This data is not warranted and is measured at room temperature (approximately 25°C).

Measured (meas.): an attribute measured during the design phase which can be compared to the expected performance, such as the amplitude drift variation with time. This data is not warranted and is measured at room temperature (approximately 25°C).

NOTE: All charts in this manual are the measurement results of multiple instruments at room temperature unless otherwise noted. The specifications (except the TG specifications) listed in this manual are those when the tracking generator is off.

Frequency

Frequency	DSA815	DSA832	DSA875	DSA832E
Frequency range	9 kHz to 1.5 GHz	9 kHz to 3.2 GHz	9 kHz to 7.5 GHz	9 kHz to 3.2 GHz
Frequency resolution	1 Hz			

Internal Reference Frequency	DSA815	DSA832	DSA875	DSA832E
Reference frequency	10 MHz			
Accuracy	± [(time since last adjustment × aging rate) + temperature stability + calibration accuracy]			
Initial calibration accuracy	<1 ppm			
Temperature stability	0°C to 50°C, reference to 25°C			
	<2 ppm	<0.5 ppm		<1 ppm
Aging rate	<2 ppm/year	<1 ppm/year		<2 ppm/year

Frequency Readout Accuracy	
Marker resolution	span/ (number of sweep points - 1)
Marker uncertainty	± (frequency indication × frequency reference uncertainty + 1% × span + 10% × resolution bandwidth + marker resolution)

Frequency Counter	
Resolution	1 Hz, 10 Hz, 100 Hz, 1 kHz, 10 kHz, 100 kHz
Uncertainty	± (frequency indication × reference frequency accuracy + counter resolution)

Frequency Span	
Range	0 Hz, 100 Hz to maximum frequency of instrument
Uncertainty	±span/ (number of sweep points - 1)

SSB Phase Noise	20°C to 30°C, f _c =1 GHz			
Carrier offset	DSA815	DSA832	DSA875	DSA832E
10 kHz	<-80 dBc/Hz	<-98 dBc/Hz		<-90 dBc/Hz, <-98 dBc/Hz (typ.)
100 kHz	<-100 dBc/Hz (typ.)	<-100 dBc/Hz (typ.)		<-100 dBc/Hz (typ.)

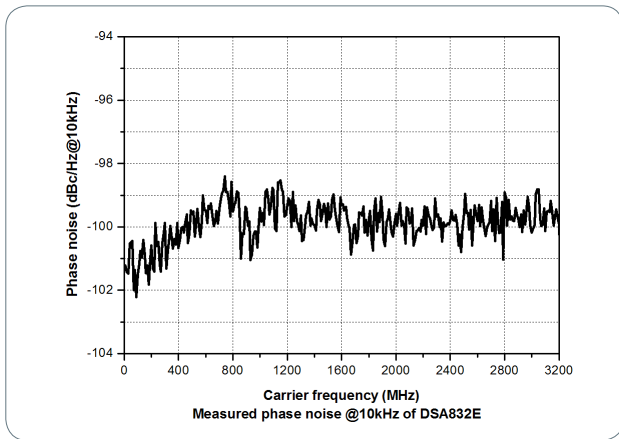
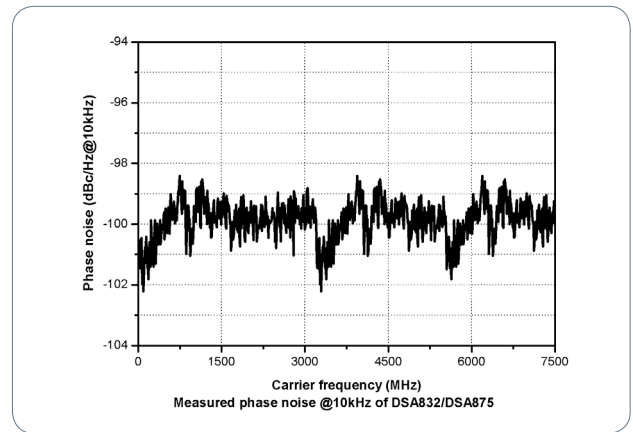
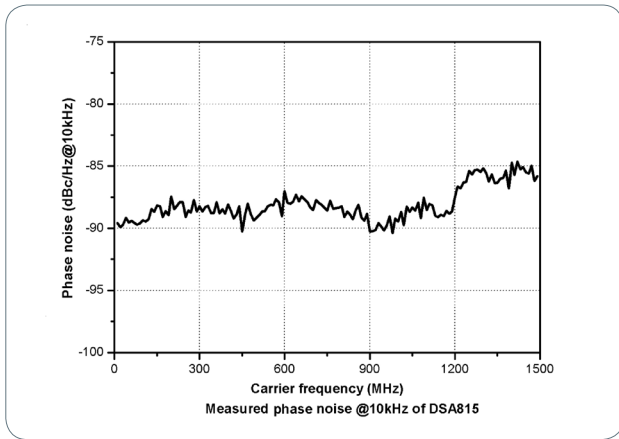

Residual FM				
	20°C to 30°C , RBW = VBW = 1 kHz			
	DSA815	DSA832	DSA875	DSA832E
Residual FM	<50 Hz (nom.)	<20 Hz (nom.)		

Bandwidths				
	Set "Auto SWT" to "Accy"			
	DSA815	DSA832	DSA875	DSA832E
Resolution bandwidth (-3 dB)	10 Hz to 1 MHz, in 1-3-10 sequence			
RBW uncertainty	<5% (nom.)			
Resolution filter shape factor (60 dB: 3 dB)	<5 (nom.)			
Video bandwidth (-3 dB)	1 Hz to 3 MHz, in 1-3-10 sequence			
Resolution bandwidth (-6 dB) (EMI-DSA800 option)	200 Hz, 9 kHz, 120 kHz			

Amplitude

Measurement Range	
Range	$f_c \geq 10$ MHz DANL to +20 dBm
Maximum Input Level	
DC voltage	50 V
CW RF power	attenuation = 30 dB +20 dBm (100 mW)
Max. damage level ^[1]	+30 dBm (1 W)

NOTE: [1] When $f_c \geq 10$ MHz, input level > +25 dBm and PA is Off, the protection switch will be on.

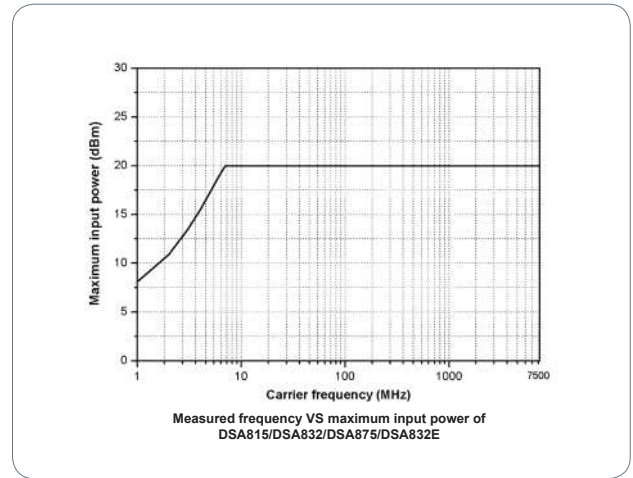
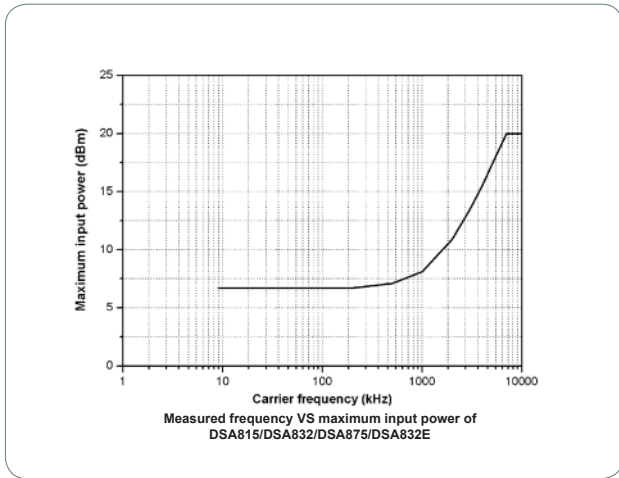

Displayed Average Noise Level (DANL)

		DSA815
Frequency		attenuation = 0 dB, RBW = VBW = 100 Hz, sample detector, trace average \geq 50, tracking generator off, 20°C to 30°C, input impedance = 50 Ω
PA off	100 kHz to 1 MHz	<-90 dBm, <-110 dBm (typ.)
	1 MHz to 1.5 GHz	<-110 dBm + 6 \times (f/1 GHz) dB, <-115 dBm (typ.)
PA on	100 kHz to 1 MHz	<-110 dBm, <-130 dBm (typ.)
	1 MHz to 1.5 GHz	<-130 dBm + 6 \times (f/1 GHz) dB, <-135 dBm (typ.)

Displayed Average Noise Level (DANL)

		DSA832	DSA875
Frequency		attenuation = 0 dB, RBW = VBW = 10 Hz, sample detector, trace average \geq 50, tracking generator off, 20°C to 30°C, input impedance = 50 Ω	
PA off	9 kHz to 100 kHz	<-110 dBm (typ.)	<-110 dBm (typ.)
	100 kHz to 5 MHz	<-125 dBm, <-128 dBm (typ.)	<-125 dBm, <-128 dBm (typ.)
	5 MHz to 3.2 GHz	<-130 dBm, <-134 dBm (typ.)	<-130 dBm, <-134 dBm (typ.)
	3.2 GHz to 6 GHz		<-126 dBm, <-130 dBm (typ.)
	6 GHz to 7.5 GHz		<-121 dBm, <-125 dBm (typ.)
PA on	100 kHz to 1 MHz	<-142 dBm (typ.)	<-142 dBm (typ.)
	1 MHz to 5 MHz	<-142 dBm, <-145 dBm (typ.)	<-142 dBm, <-145 dBm (typ.)
	5 MHz to 3.2 GHz	<-147 dBm, <-151 dBm (typ.)	<-147 dBm, <-151 dBm (typ.)
	3.2 GHz to 6 GHz		<-143 dBm, <-147 dBm (typ.)
	6 GHz to 7.5 GHz		<-138 dBm, <-142 dBm (typ.)

Displayed Average Noise Level (DANL)

		DSA832E
Frequency		attenuation = 0 dB, RBW = VBW = 10 Hz, sample detector, trace average \geq 50, tracking generator off, 20°C to 30°C, input impedance = 50 Ω
PA off	9 kHz to 100 kHz	<-110 dBm (typ.)
	100 kHz to 5 MHz	<-122 dBm, <-128 dBm (typ.)
	5 MHz to 3.2 GHz	<-127 dBm, <-134 dBm (typ.)
PA on	100 kHz to 1 MHz	<-142 dBm (typ.)
	1 MHz to 5 MHz	<-140 dBm, <-145 dBm (typ.)
	5 MHz to 3.2 GHz	<-145 dBm, <-151 dBm (typ.)

Displayed Average Noise Level (DANL) (Normalized to 1Hz)

	DSA815	DSA832	DSA875	DSA832E
Frequency	attenuation = 0 dB, RBW = VBW = 100 Hz, sample detector, trace average ≥ 50, tracking generator off, normalized to 1Hz, 20°C to 30°C, input impedance = 50 Ω			
PA off	9 kHz to 100 kHz	<-120 dBm (typ.)	<-120 dBm (typ.)	<-120 dBm (typ.)
	100 kHz to 1 MHz	<-110 dBm, <-130 dBm (typ.)	<-135 dBm, <-138 dBm (typ.)	<-135 dBm, <-138 dBm (typ.)
	1 MHz to 5 MHz	<-130 dBm + 6 × (f/1 GHz) dB, <-135 dBm (typ.)	<-140 dBm, <-144 dBm (typ.)	<-140 dBm, <-144 dBm (typ.)
	5 MHz to 1.5 GHz			<-137 dBm, <-144 dBm (typ.)
	1.5 GHz to 3.2 GHz			
	3.2 GHz to 6 GHz			<-136 dBm, <-140 dBm (typ.)
PA on	6 GHz to 7.5 GHz		<-131 dBm, <-135 dBm (typ.)	
	100 kHz to 1 MHz	<-130 dBm, <-150 dBm (typ.)	<-152 dBm (typ.)	<-152 dBm (typ.)
	1 MHz to 5 MHz	<-150 dBm + 6 × (f/1 GHz) dB, <-155 dBm (typ.)	<-152 dBm, <-155 dBm (typ.)	<-152 dBm, <-155 dBm (typ.)
	5 MHz to 1.5 GHz		<-157 dBm, <-161 dBm (typ.)	<-155 dBm, <-161 dBm (typ.)
	1.5 GHz to 3.2 GHz			
	3.2 GHz to 6 GHz			<-153 dBm, <-157 dBm (typ.)
6 GHz to 7.5 GHz			<-148 dBm, <-152 dBm (typ.)	

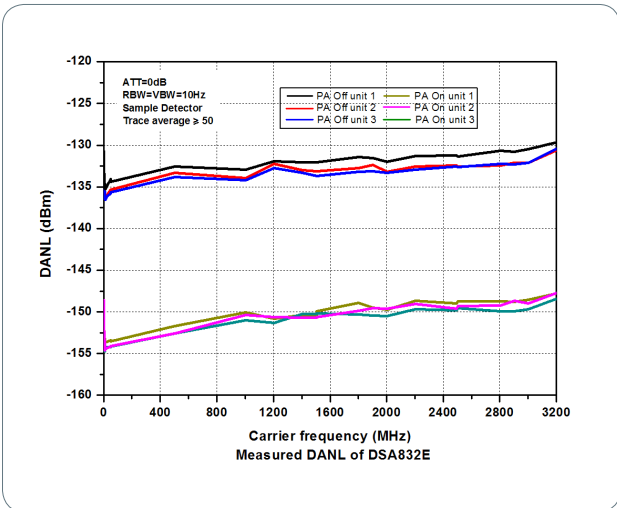
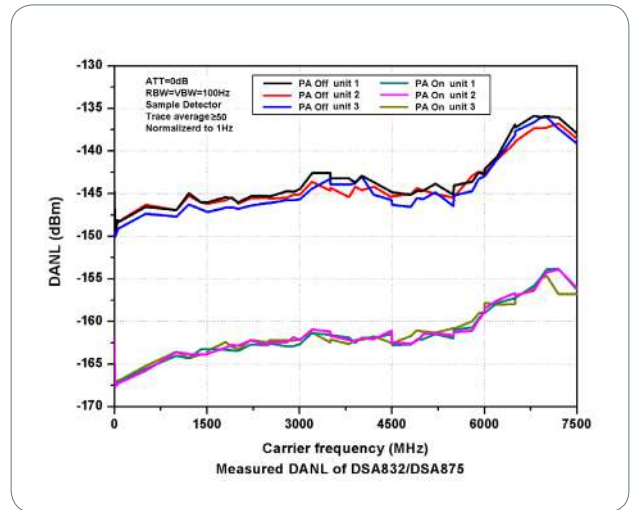
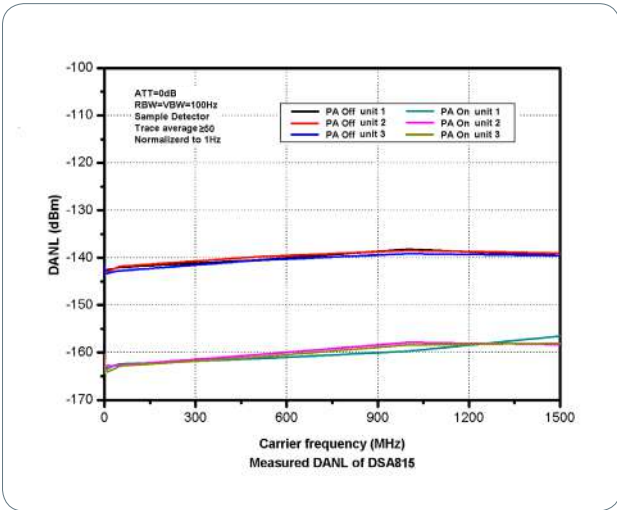

Level Display

Logarithmic level axis	1 dB to 200 dB
Linear level axis	0 to reference level
Number of display points	601
Number of traces	3 + math trace
Trace detectors	normal, positive-peak, negative-peak, sample, RMS, voltage average quasi-peak (with EMI-DSA800 option)
Trace functions	clear write, max hold, min hold, average, view, blank
Units of level axis	dBm, dBmV, dBμV, nV, μV, mV, V, nW, μW, mW, W

Frequency Response

	DSA815	DSA832	DSA875	DSA832E
Frequency response	$f_c \geq 100$ kHz, attenuation = 10 dB, relative to 50 MHz, 20°C to 30°C			
PA off	100 kHz to 1.5 GHz	<0.7 dB	<0.5 dB, <0.3 dB (typ.)	<0.5 dB, <0.3 dB (typ.)
	1.5 GHz to 3.2 GHz			<0.7 dB
	3.2 GHz to 7.5 GHz		<0.7 dB, <0.3 dB (typ.)	
	$f_c \geq 1$ MHz, attenuation = 10 dB, relative to 50 MHz, 20°C to 30°C			
PA on	100 kHz to 1.5 GHz	<1.0 dB	<0.7 dB, <0.3 dB (typ.)	<0.7 dB, <0.3 dB (typ.)
	1.5 GHz to 3.2 GHz			<1.0 dB
	3.2 GHz to 7.5 GHz		<0.9 dB, <0.3 dB (typ.)	

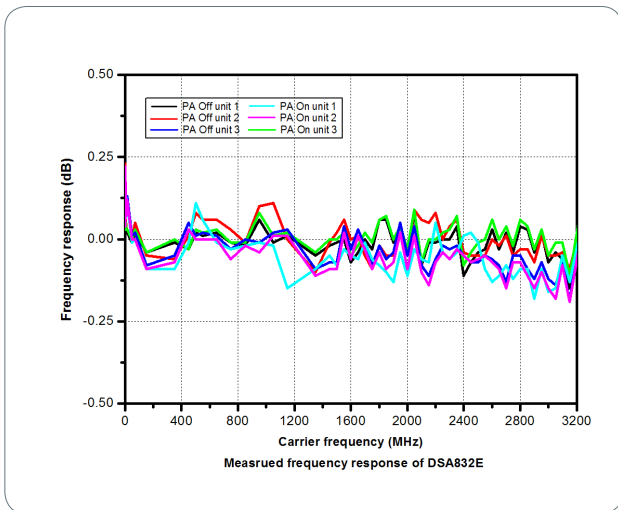
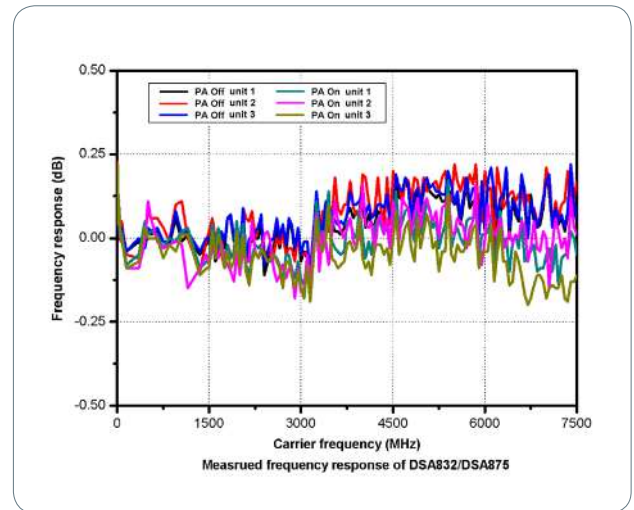
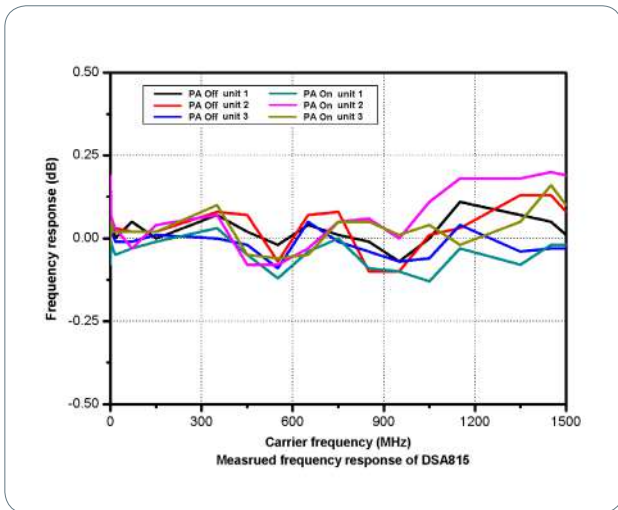

Input Attenuation Switching Uncertainty				
	DSA815	DSA832	DSA875	DSA832E
Setting range	0 to 30 dB, in 1 dB step			
Switching uncertainty	$f_c=50$ MHz, relative to 10 dB, 20 °C to 30 °C			
	<0.5 dB		<0.3 dB	

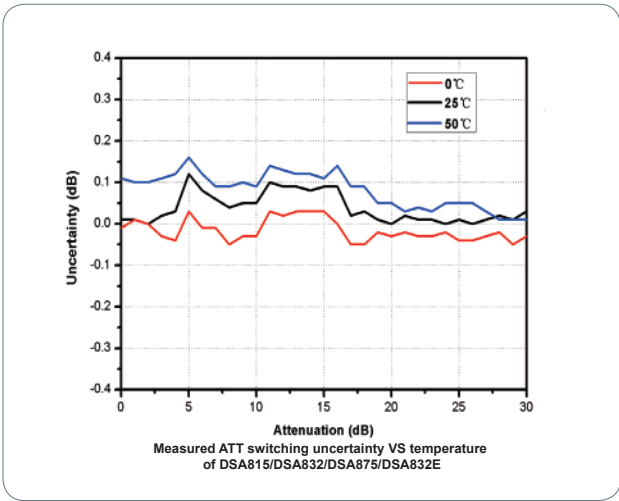

Absolute Amplitude Uncertainty				
	DSA815	DSA832	DSA875	DSA832E
Uncertainty	$f_c = 50$ MHz, peak detector, preamplifier off, attenuation = 10 dB, input signal level = -10 dBm, 20 °C to 30 °C			
	<0.4 dB		<0.3 dB	

RBW Switching Uncertainty	
Uncertainty	relative to 1 kHz RBW
	<0.1 dB

Reference Level		
Range	-100 dBm to +20 dBm, in 1 dB step	
Resolution	log scale	0.01 dB
	linear scale	4 digits

Preamplifier					
		DSA815	DSA832	DSA875	DSA832E
Gain	100 kHz to 1.5 GHz	20 dB (nom.)	17 dB (nom.)	17 dB (nom.)	17 dB (nom.)
	1.5 GHz to 3.2 GHz				
	3.2 GHz to 7.5 GHz				

Level Measurement Uncertainty				
	DSA815	DSA832	DSA875	DSA832E
Level measurement uncertainty	95% confidence level, S/N>20 dB, RBW = VBW = 1 kHz, preamplifier off, attenuation = 10 dB, -50 dBm < input level ≤ 0 dBm, $f_c > 10$ MHz, 20 °C to 30 °C			
	<1.5 dB (nom.)		<0.8 dB (nom.)	
			<1.0 dB (nom.)	

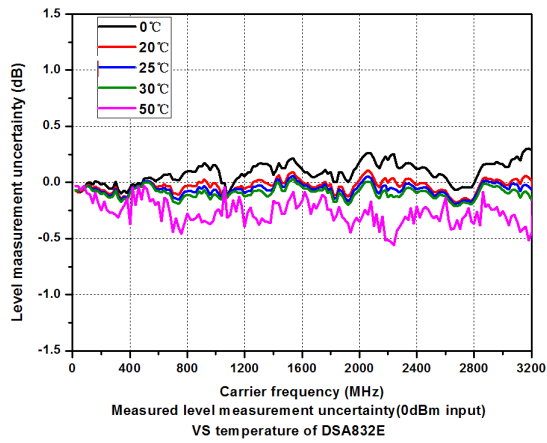
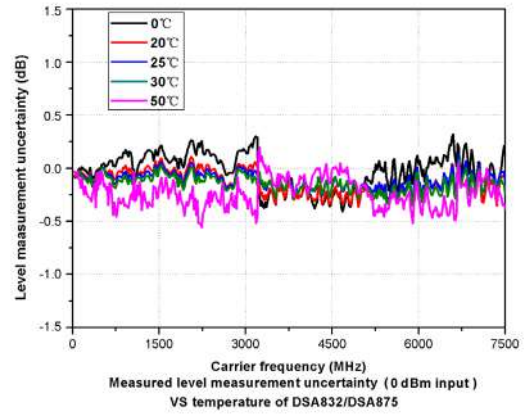
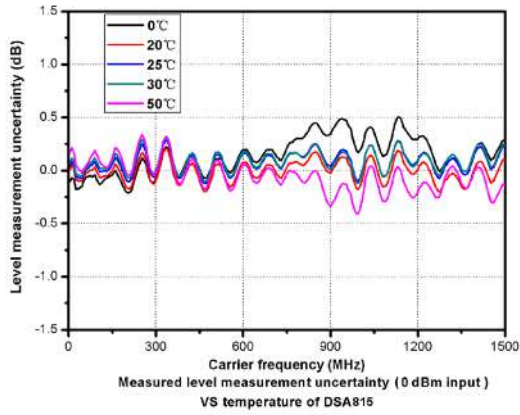

RF Input VSWR

		DSA815	DSA832	DSA875	DSA832E
		attenuation ≥ 10 dB			
VSWR	300 kHz to 1.5 GHz	<1.5 (nom.)	<1.5 (nom.)	<1.5 (nom.)	<1.5 (nom.)
	1.5 GHz to 3.2 GHz			<1.8 (nom.)	
	3.2 GHz to 7.5 GHz				

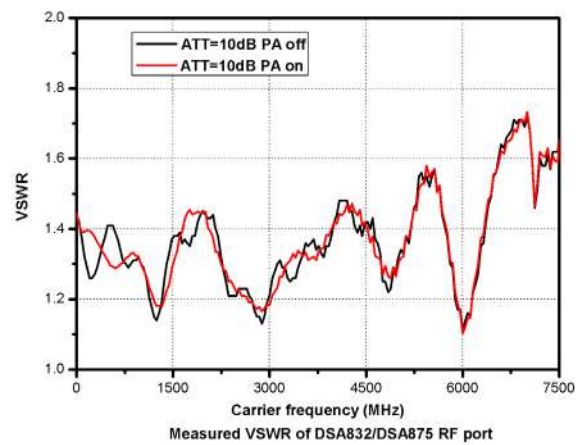
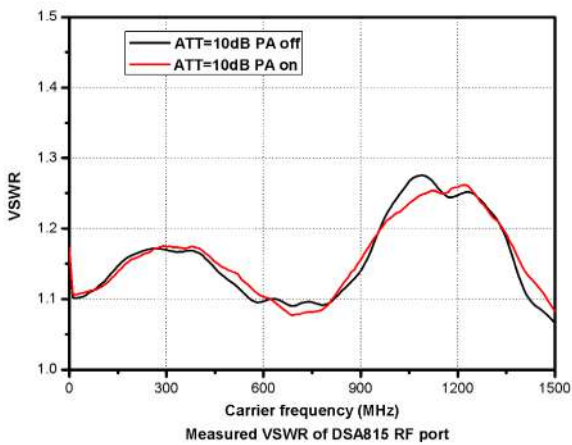

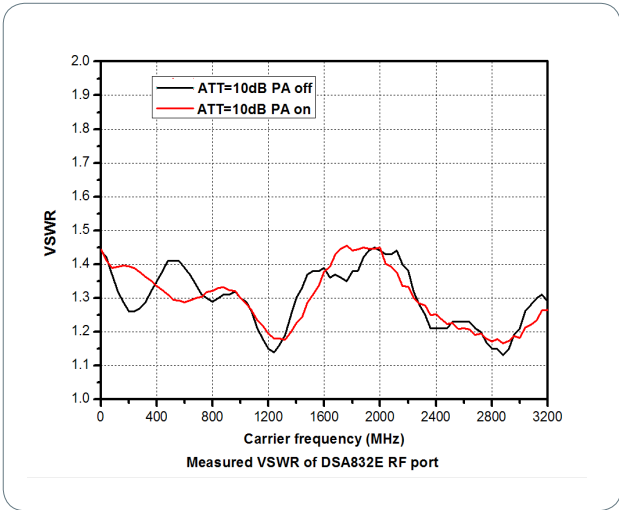

Distortion

Second Harmonic Intercept				
	DSA815	DSA832	DSA875	DSA832E
Second harmonic intercept (SHI)	$f_c \geq 50$ MHz, input signal level = -20 dBm, attenuation = 10 dB			
	+40 dBm	+45 dBm		+40 dBm
Third-order Intercept				
	DSA815	DSA832	DSA875	DSA832E
Third-order intercept (TOI)	$f_c \geq 50$ MHz, two -20 dBm tones at input mixer spaced by 200 kHz, attenuation = 10 dB			
	+10 dBm	+11 dBm, +15 dBm (typ.)		+7 dBm
1 dB Gain Compression				
1 dB compression of input mixer (P_{1dB})	$f_c \geq 50$ MHz, attenuation = 0 dB			
	>0 dBm			

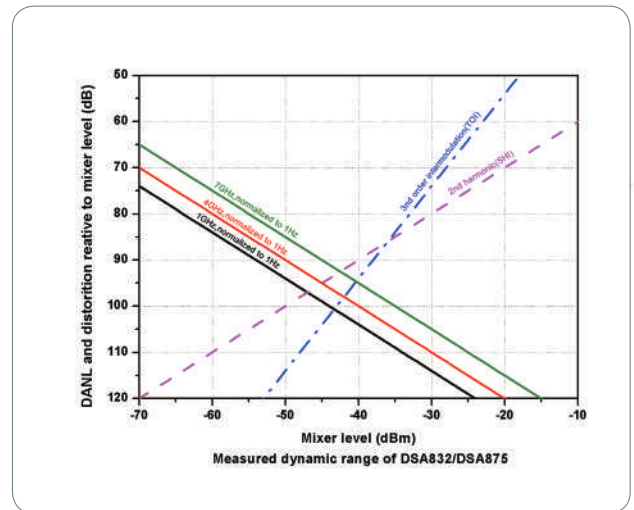
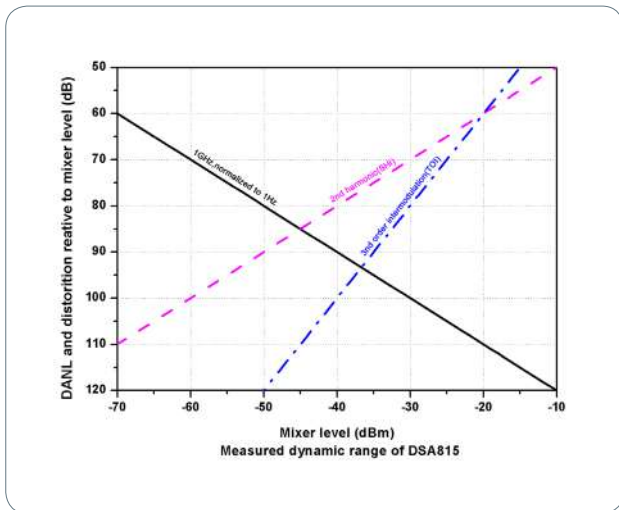

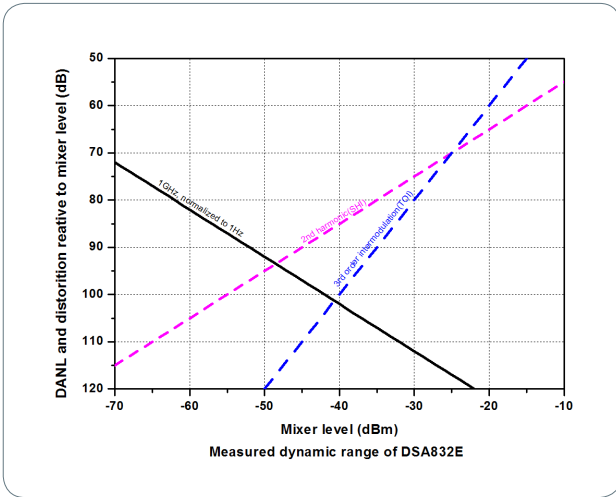

Spurious Responses

	DSA815	DSA832	DSA875	DSA832E
Spurious response	input terminated 50 Ω, attenuation = 0 dB, 20°C to 30°C			
	<-88 dBm (typ.)		<-90 dBm ^[1] , <-100 dBm (typ.)	
Intermediate frequency	<-60 dBc			
System related sidebands	referenced to local oscillators, referenced to A/D conversion, referenced to subharmonic of first LO, referenced to harmonic of first LO			
	<-60 dBc			
Input related spurious	mixer level = -30 dBm			
	<-60 dBc			

Sweep

Sweep		DSA815	DSA832	DSA875	DSA832E
Sweep time	span ≥ 100 Hz	10 ms to 1500s	1 ms to 1500 s	1 ms to 1500 s	1 ms to 3200 s
	zero span	20 μs to 1500 s	20 μs to 3200 s	20 μs to 7500 s	20 μs to 3200 s
Sweep time uncertainty	span ≥ 100 Hz	5% (nom.)			
	zero span (sweep time setting value > 1 ms)	5% (nom.)			
Sweep mode	continuous, single				

Tracking Generator (Option)

TG Output		DSA815	DSA832	DSA875	DSA832E
Frequency range		100 kHz to 1.5 GHz	100 kHz to 3.2 GHz	100 kHz to 7.5 GHz	100 kHz to 3.2 GHz
Output level range		-20 dBm to 0 dBm	-40 dBm to 0 dBm		
Output level resolution		1 dB			
Output flatness		relative to 50 MHz			
		±3 dB (nom.)			

NOTE: [1] Except the internal local oscillator (1820 MHz) and its harmonics.

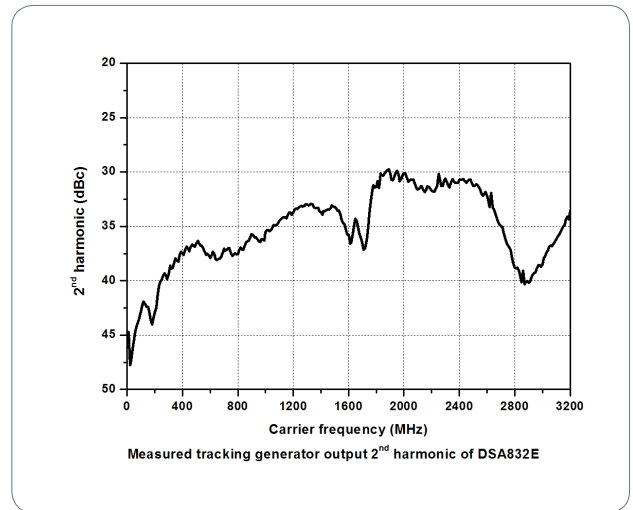
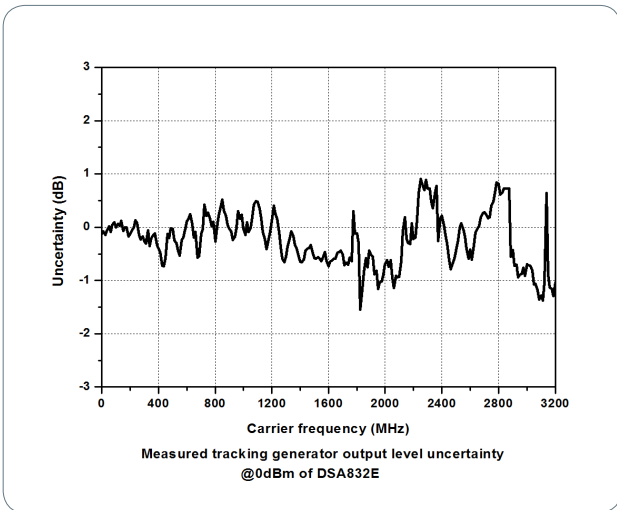
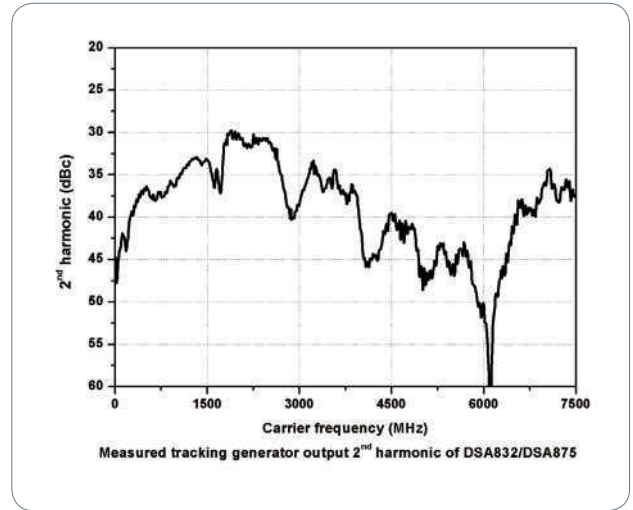
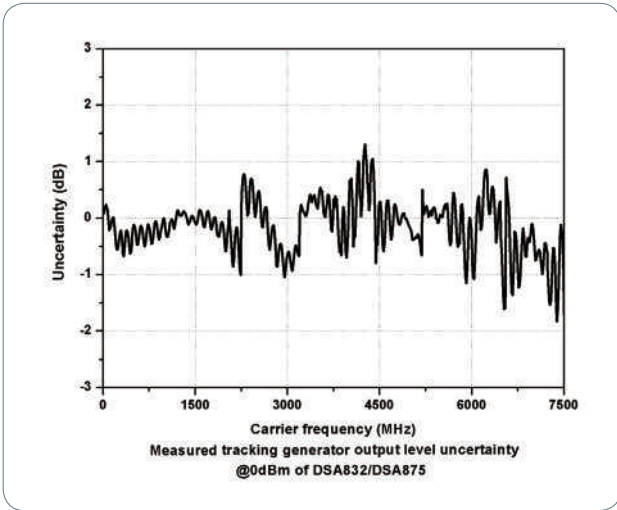

Trigger Functions

Trigger	
Trigger source	free run, video, external
External trigger level	5 V TTL level

SSC-DSA (Option) (Only for DSA815)

Signal Seamless Capture (SSC)	
Measurement bandwidth	1.5 MHz

Input /Output

Front Panel Connectors		
RF input	impedance	50 Ω (nom.)
	connector	N female
Tracking generator output	impedance	50 Ω (nom.)
	connector	N female

Internal/ External Reference		
Internal reference	frequency	10 MHz
	output level	+3 dBm to +10 dBm, +8 dBm (typ.)
	impedance	50 Ω (nom.)
	connector	BNC female
External reference	frequency	10 MHz \pm 5 ppm
	input level	0 dBm to +10 dBm
	impedance	50 Ω (nom.)
	connector	BNC female

External Trigger Input		
External trigger input	impedance	1 k Ω (nom.)
	connector	BNC female

Communication Interface		
USB host	connector	A plug
	protocol	version2.0
USB device	connector	B plug
	protocol	version2.0
LAN	LXI core 2011 device	10/100Base, RJ-45
IEC/IEEE (GPIB) bus (USB-GPIB option)		IEEE488.2

General Specifications

Display	
Type	TFT LCD
Resolution	800 x 480 pixels
Size	8 inch
Colors	64 k

Printer Supported	
Protocol	PictBridge

Mass Memory	
Mass memory	flash disk (internal), USB storage device (not supplied)

Power Supply	
Input voltage range, AC	100 V to 240 V (nom.)
AC supply frequency	45 Hz to 440 Hz
Power consumption	35 W (typ.), max. 50 W with all options

Environmental		
Temperature	operating temperature range	0°C to 50°C
	Storage temperature range	-20°C to 70°C
Humidity	0°C to 30°C	\leq 95% rel. humidity
	30°C to 40°C	\leq 75% rel. humidity
Altitude	operating height	up to 3,000m

Electromagnetic Compatibility and Safety	
EMC	in line with EMC instruction (2014/30/EU), in line with or exceed IEC61326-1: 2013/EN61326-1: 2013 Group 1 Class A standard CISPR 11/EN 55011
	IEC 61000-4-2:2008/EN 61000-4-2 ±4.0 kV (contact discharge), ±8.0 kV (air discharge)
	IEC 61000-4-3:2002/EN 61000-4-3 3 V/m (80 MHz to 1 GHz); 3 V/m (1.4 GHz to 2 GHz); 1 V/m (2.0 GHz to 2.7 GHz)
	IEC 61000-4-4:2004/EN 61000-4-4 1 kV power lines
	IEC 61000-4-5:2001/EN 61000-4-5 0.5 kV (phase to neutral); 1 kV (phase to PE); 1 kV (neutral to PE)
	IEC 61000-4-6:2003/EN 61000-4-6 3 V, 0.15-80MHz
	IEC 61000-4-11:2004/EN 61000-4-11 voltage dip: 0% UT during half cycle; 0% UT during 1 cycle; 70% UT during 25 cycles short interruption: 0% UT during 250 cycles
Electrical safety	IEC 61010-1:2010 (Third Edition)/EN 61010-1:2010, UL 61010-1:2012 R4.16 and CAN/CSA-C22.2 NO. 61010-1-12+ GI1+ GI2

Dimensions	
(W x H x D)	361.6 mm × 178.8 mm × 128 mm (14.2 in × 7.0 in × 5.0 in)

Weight				
	DSA815	DSA832	DSA875	DSA832E
Standard	4.25 kg (9.4 lb)	4.55 kg (10.0 lb)		
With tracking generator		5.15 kg (11.4 lb)		

Calibration Interval	
Recommended calibration interval	18 months

► Ordering Information

	Description	Order Number
Model	spectrum analyzer, 9 kHz to 1.5 GHz	DSA815
	spectrum analyzer, 9 kHz to 3.2 GHz	DSA832
	spectrum analyzer, 9 kHz to 7.5 GHz	DSA875
	spectrum analyzer, 9 kHz to 3.2 GHz	DSA832E
	spectrum analyzer, 9 kHz to 1.5 GHz (with tracking generator, factory installed)	DSA815-TG
	spectrum analyzer, 9 kHz to 3.2 GHz (with tracking generator, factory installed)	DSA832-TG
	spectrum analyzer, 9 kHz to 7.5 GHz (with tracking generator, factory installed)	DSA875-TG
	spectrum analyzer, 9 kHz to 3.2 GHz (with tracking generator, factory installed)	DSA832E-TG
Standard accessories	quick guide (hard copy)	-
	power cable	-
Options	EMI filter & quasi-peak detector	EMI-DSA800
	Advanced measurement kit	AMK-DSA800
	VSWR measurement kit	VSWR-DSA800
	DSA PC software	Ultra Spectrum
	EMI Pre-compliance test software	S1210 EMI Pre-compliance Software
	ASK-FSK Demodulation Analysis (only for DSA832/DSA875/DSA832E)	S1220 ASK-FSK Demodulation Analysis Software
	signal seamless capture (only for DSA815)	SSC-DSA
Optional accessories	include: N-SMA cable, BNC-BNC cable, N-BNC adaptor, N-SMA adaptor, 75 Ω to 50 Ω adaptor, 900 MHz/1.8 GHz antenna (2pcs), 2.4 GHz antenna (2pcs)	DSA Utility Kit
	include: N(F)-N(F) adaptor (1pcs), N(M)-N(M) adaptor (1pcs), N(M)-SMA(F) adaptor (2pcs), N(M)-BNC(F) adaptor (2pcs), SMA(F)-SMA(F) adaptor (1pcs), SMA(M)-SMA(M) adaptor (1pcs), BNC T type adaptor (1pcs), 50 Ω SMA load (1pcs), 50 Ω BNC impedance adaptor (1pcs)	RF Adaptor Kit
	include: 50 Ω to 75 Ω adaptor (2pcs)	RF CATV Kit
	include: 6 dB attenuator (1pcs), 10 dB attenuator (2pcs)	RF Attenuator Kit
	30 dB high power attenuator, max. power 100 W	ATT03301H
	N(M)-N(M) RF cable	CB-NM-NM-75-L-12G
	N(M)-SMA(M) RF cable	CB-NM-SMAM-75-L-12G
	RF demo kit (transmitter)	TX1000
	RF demo kit (receiver)	RX1000
	VSWR bridge, 1 MHz to 3.2 GHz	VB1032
	VSWR bridge, 800 MHz to 4 GHz	VB1040
	VSWR bridge, 2 GHz to 8 GHz	VB1080
	near field probe	NFP-3
	rack mount kit	RM-DSA800
	soft carrying bag	BAG-G1
USB cable	CB-USBA-USBB-FF-150	
USB to GPIB interface converter for instrument	USB-GPIB	

Warranty

Three-year warranty, excluding probes and accessories.



HEADQUARTER

RIGOL TECHNOLOGIES, INC.
No.156,Cai He Village,
Sha He Town,
Chang Ping District, Beijing,
102206 P.R.China
Tel:+86-10-80706688
Fax:+86-10-80720067
Electronic Measurement
Instrument service and support
email:EMD_support@rigol.com

EUROPE

RIGOL TECHNOLOGIES EU GmbH
Lindbergh str. 4
82178 Puchheim
Germany
Tel: 0049- 89/89418950
Email: info-europe@rigol.com

NORTH AMERICA

RIGOL TECHNOLOGIES, USA INC.
8140 SW Nimbus Ave.
Beaverton, OR 97008
Tel: 877-4-**RIGOL**-1
Email: info@rigol.com

JAPAN

RIGOL TECHNOLOGIES JAPAN, LLC
MJ BLDG.3F,1-7-4 MINATO,CHUOU-
KU,TOKYO,JAPAN 〒104-0043
Tel: 03-6262-8932
Fax: 03-6262-8933
Email: info-japan@rigol.com

RIGOL® is the registered trademark of **RIGOL** Technologies, Inc. Product information in this document subject to update without notice. For the latest information about **RIGOL**'s products, applications and services, please contact local **RIGOL** office or access **RIGOL** official website: www.rigol.com

