

Anritsu Advancing beyond

VNA Master™

Affordable Handheld Vector Network +
Spectrum Analyzer for Cable, Antenna, and
Signal Analysis Anytime, Anywhere

MS2024B, MS2025B

500 kHz to 4 GHz, 6 GHz, Vector Network Analyzer

MS2034B, MS2035B

500 kHz to 4 GHz, 6 GHz, Vector Network Analyzer

9 kHz to 4 GHz, 6 GHz, Spectrum Analyzer



Introduction

Anritsu proudly offers the MS202xB/MS203xB VNA Master + Spectrum Analyzer, the industry's most affordable and compact handheld solution to address cable, antenna, component, and signal analysis needs in the field. All MS202xB/3xB VNA Master models offer benchtop accuracy and high performance S-parameter measurements in portable form. With frequency coverage from 500 kHz up to 4 or 6 GHz in a truly handheld, battery-operated, rugged, multi-function instrument, the VNA Master also provides a field-friendly touchscreen user interface.

MS2034B/35B models include a powerful spectrum analyzer which multiplies user convenience by combining both a VNA and a separate spectrum analyzer into a single measurement powerhouse for the harsh RF and physical environments of field test. Whether it is for spectrum monitoring, broadcast proofing, interference analysis, RF and microwave measurements, regulatory compliance, 3G/4G, Land Mobile Radio, or wireless data network measurements, this VNA/Spectrum Analyzer combination is the ideal instrument for making fast and reliable measurements in the field.

Vector Network Analyzer Performance and Functional Highlights (all models)

- Broadband coverage of 500 kHz to 4/6 GHz
- 1-path, 2-port Vector Network Analyzer
- Intuitive Graphical User Interface (GUI) with convenient Touch Screen
- VNA-quality error correction for directivity and source match
- 2-port Transmission Measurements: High/Default/Low Power
- Outstanding calibration stability, minimal drift error
- Calibration Interpolation feature adds flexibility
- User-defined overlays for viewing multiple S-Parameters
- Arbitrary data points up to 4001
- IF Bandwidth selections of 10 Hz to 100 kHz
- 100 dB Transmission Dynamic Range
- 850 μ s/data point sweep speed
- Greater than 3 hour battery life
- USB and Ethernet for data transfer and instrument control
- User-selectable menu options: Choose either VNA or Field Mode for simplified Cable & Antenna analysis
- Field upgradable firmware
- Internal Flash Memory: 2 GB — Store more than 4000 traces and setups in memory
- Portable: 3.5 kg (7.6 lb)
- Full Speed USB Memory support
- Automate repetitive tasks via Ethernet and USB
- High resolution daylight-viewable TFT color display
- "Glove Friendly" Resistive Touchscreen Display
- Distance Domain (Standard with firmware V1.20 and above)
- Internal Bias Tee Option
- Vector Voltmeter Option, ideal for cable phase matching
- High Accuracy Power Meter Option
- GPS Receiver Option
- Polar Format Impedance Display
- Complies with MIL-PRF-28800F Class 2.
- Certified for use in Explosive Atmosphere per MIL-PRF-28800F and MIL-STD-810G

Spectrum Analyzer Performance and Functional Highlights (MS203xB models only)

- Measure: Occupied Bandwidth, Channel Power, ACPR, C/I
- Interference Analyzer: Spectrogram, Signal Strength, RSSI, Signal ID
- Dynamic Range: > 95 dB in 10 Hz RBW
- DANL: -162 dBm in 1 Hz RBW (normalized)
- Phase Noise: -100 dBc/Hz max @ 10 kHz offset at 1 GHz
- Frequency Accuracy: ± 50 ppb 3 minutes after GPS lock
- Traces: Normal, Max Hold, Min Hold, Average, # of Averages
- Detectors: Peak, Negative, Sample, Quasi-peak, and RMS
- Markers: 6, each with a Delta Marker, or 1 Reference Marker with 6 Delta Markers
- Trace Save-on-Event: crossing limit line or sweep complete
- PIM Hunting
- Limit Lines: up to 41 segments with one-button envelope creation
- AM/FM/SSB Audio-only Demodulation
- Optional AM/FM/PM Demodulation Analyzer
- Store thousands of traces internally
- Channel Scanner Option
- GPS tagging of stored traces
- Internal Pre-amplifier standard
- High Accuracy Power Meter Option
- Coverage Mapping Option

Table of Contents

Definitions.....3

VNA Performance Specifications.....4

VNA Functional Specifications.....5

Corrected System Performance and Uncertainties — High Port Power, N-Type.....6

Corrected System Performance and Uncertainties — High Port Power, K-Type.....7

Spectrum Analyzer Performance Specifications.....8

Spectrum Analyzer Functional Specifications.....9

Bias Tee (Option 10).....10

Vector Voltmeter (Option 15).....10

Distance Domain.....10

High Accuracy Power Meter (Option 19).....11

Interference Analyzer (Option 25).....11

Channel Scanner (Option 27).....11

GPS (Option 31).....12

Coverage Mapping (Option 431).....12

Ethernet Connectivity.....12

AM/FM/PM Demodulation Analyzer (Option 509).....13

General Specifications.....14

Line Sweep Tools.....16

Master Software Tools.....16

Web Remote Control.....17

Programmable Remote Control.....17

Ordering Information.....18

Standard Accessories.....19

USB Power Sensors.....19

Optional Accessories.....20

Manuals.....30

Definitions

Specifications	All specifications and characteristics apply to Revision 2 instruments under the following conditions, unless otherwise stated:
Temperature Range	Over the 23 °C ± 5 °C temperature range.
Warm-Up Time	After 10 minutes of warm-up time in VNA mode, where the instrument is left in the ON state.
Mode	Sweep Mode set to Performance.
Reference Signal	When using internal reference signal.
Typical Performance	Typical specifications that are not in parenthesis are not tested and not warranted. They are generally representative of characteristic performance. Typical specifications in parenthesis () represent the mean value of measured units and do not include any guard-bands or uncertainties. They are not warranted.
Uncertainty	A coverage factor of x1 is applied to the measurement uncertainties to facilitate comparison with other industry handheld analyzers.
Time Base Error	Input Frequency × Frequency Reference Error
Calibration Cycle	Calibration is within the recommended 12 month period (residual specifications also require calibration kit



VNA Performance Specifications

Block Diagram

As shown in the following block diagram, the VNA Master has a 2-port, 1-path architecture that automatically measures 2 S-parameters with error-correction precision inherent to VNA operation. The above illustration is a simplified block diagram of the VNA Master 2-port, 1-path architecture. The magnitude AND phase information gained from Vector Network data enables the VNA Master to provide improved field measurements with greater accuracy.

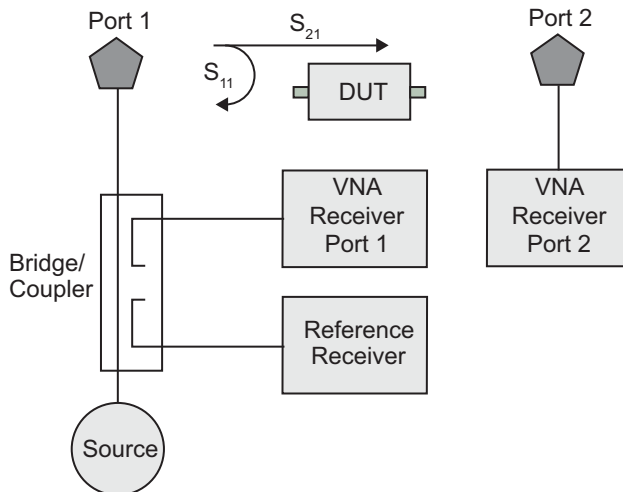

Frequency

MS2024/34B	500 kHz to 4 GHz
MS2025/35B	500 kHz to 6 GHz
Frequency Accuracy	2.5 ppm
Frequency Resolution	1 Hz

Test Port Power (Typical)

VNA Master supports selection of High, Default, or Low test port power. Changing power after calibration can degrade the calibrated performance. Typical power by bands:

Frequency Range	High Port Power (dBm)	Default Port Power (dBm)	Low Port Power (dBm)
500 kHz to < 3 GHz	+3	-5	-25
3 GHz to 6 GHz	0	-5	-25

Transmission Dynamic Range

The transmission dynamic range (the difference between test port power and noise floor) using 10 Hz IF Bandwidth and High Port Power:

2 MHz to ≤ 4 GHz	100 dB
4 GHz to ≤ 6 GHz	90 dB

Sweep Speed (Typical)

Sweep speed in μs/point for IF Bandwidth of 100 kHz, 1001 data points, and single display. The two-receiver architecture will simultaneously collect S₂₁ and S₁₁ in a single sweep.

500 kHz to 6 GHz	850 μs/point
------------------	--------------

Noise Floor

Frequency	Noise Floor (typical)
500 kHz to 3 GHz	-100 dBm
3 GHz to 4 GHz	-103 dBm
4 GHz to 6 GHz	-93 dBm

Temperature Stability (S₁₁ or S₂₁, Short, 23 °C ± 5 °C)

Frequency Range	Magnitude (typical)	Phase (typical)
500 kHz to < 6 GHz	0.020 dB/°C	0.200 deg/°C

Interference Immunity

On-Channel	+17 dBm at > 1.0 MHz from carrier frequency
On-Frequency	0 dBm within ± 10 kHz of the carrier frequency



VNA Functional Specifications

Measurements

Measurement Parameters	S_{11}, S_{21}
Number of Traces	Four: TR1, TR2, TR3, TR4
Trace Format	Single, Dual, Tri, Quad. When used with Number of Traces, overlays are possible including a Single Format with Four trace overlays.
Graph Types	Log Magnitude, SWR, Phase, Real, Imaginary, Group Delay, Smith Chart, Log Mag/2 (1-Port Cable Loss), Linear Polar, Log Polar, Real Impedance, Imaginary Impedance
Domains	Frequency Domain, Distance Domain
Frequency	Start Frequency, Stop Frequency, Center Frequency, Span
Distance	Start Distance, Stop Distance
Frequency Sweep Type: Linear	Single Sweep, Continuous
Data Points	2 to 4001 (arbitrary setting); data points can be reduced without recalibration.
Limit Lines	Upper, Lower, 10 segmented Upper, 10 segmented Lower
Test Limits	Pass/Fail for Upper, Pass/Fail for Lower, Limit Audible Alarm
Data Averaging	Sweep-by-sweep
Smoothing	0 to 20 %
IF Bandwidth	10, 20, 50, 100, 200, 500, 1 k, 2 k, 5 k, 10 k, 20 k, 50 k, 100 k (Hz)
Reference Plane	The reference planes of a calibration (or other normalization) can be changed by entering a line length. Assumes no loss, flat magnitude, linear phase, and constant impedance.
Auto Reference Plane Extension	Instead of manually entering a line length, this feature automatically adjusts phase shift from the current calibration (or other normalization) to compensate for external cables (or test fixtures). Assumes no loss, flat magnitude, linear phase, and constant impedance.
Frequency Range	Frequency range of the measurement can be narrowed (reduces number of data points) within the calibration range without recalibration. When Interpolation is On, narrowed frequency range will retain original number of data points.
Group Delay Aperture	Defined as the frequency span over which the phase change is computed at a given frequency point. The aperture can be changed without recalibration. The minimum aperture is the frequency range divided by the number of points in calibration and can be increased to 20% of the frequency range.
Group Delay Range	< 180° of phase change within the aperture
Trace Memory	A separate memory for each trace can be used to store measurement data for later display. The trace data can be saved and recalled.
Trace Math	Complex trace math operations of subtraction, addition, multiplication, or division are provided.
Number of Markers	12, arbitrary assignments to any trace
Marker Types	Reference, Delta
Marker Readout Styles	Log Mag, Cable Loss (Log Mag/2), Log Mag and Phase, Phase, Real and Imaginary, SWR, Impedance, Admittance, Normalized Impedance, Normalized Admittance, Polar Impedance, and Group Delay
Marker Search	Peak Search, Valley Search, Find Marker Value
Calibration Type	Full S_{11} , 1-Path, 2-Port (S_{11} and S_{21}), Response S_{11} , Response S_{21}
Calibration Methods	Short-Open-Load-Through (SOLT)
Calibration Standards' Coefficients	Coax: N-Connector, K-Connector, 7/16, TNC, SMA, and four User Defined
Cal Correction Toggle	On/Off
Interpolation	On/Off (Interpolation may be activated before or after calibration)
Impedance Conversion (Smith Chart)	Support for 50 Ω and 75 Ω are provided.
Units	Meters, Feet
Bias Tee Settings	Internal, Off
Timebase Reference	Internal
File Storage Types	Measurement, Setup (with CAL), Setup (without CAL), S2P (Real/Imag), S2P (Lin Mag/Phase), S2P (Log Mag/Phase), JPEG
Ethernet Configuration	DHCP or Manual (Static); IP, Gateway, Subnet entries
Languages	English, French, German, Spanish, Chinese, Japanese, Korean, Italian, Russian plus one User Defined

Corrected System Performance and Uncertainties — High Port Power, N-Type

Measurement Accuracy¹ OSLN50A-8 or OSLNF50A-8, TOSLN50A-8 or TOSLNF50A-8.

Frequency Range	Directivity (dB)	Source Match (dB)	Reflection Tracking (dB)	Transmission Tracking (dB)
< 20 MHz	≥ 42	≥ 30	± 0.01	± 0.01
20 MHz to < 3 GHz	≥ 42	≥ 30	± 0.05	± 0.01
3 GHz to 6 GHz	≥ 42	≥ 30	± 0.05	± 0.01

Corrected Measurement Uncertainty (Transmission from Port 1 to Port 2)

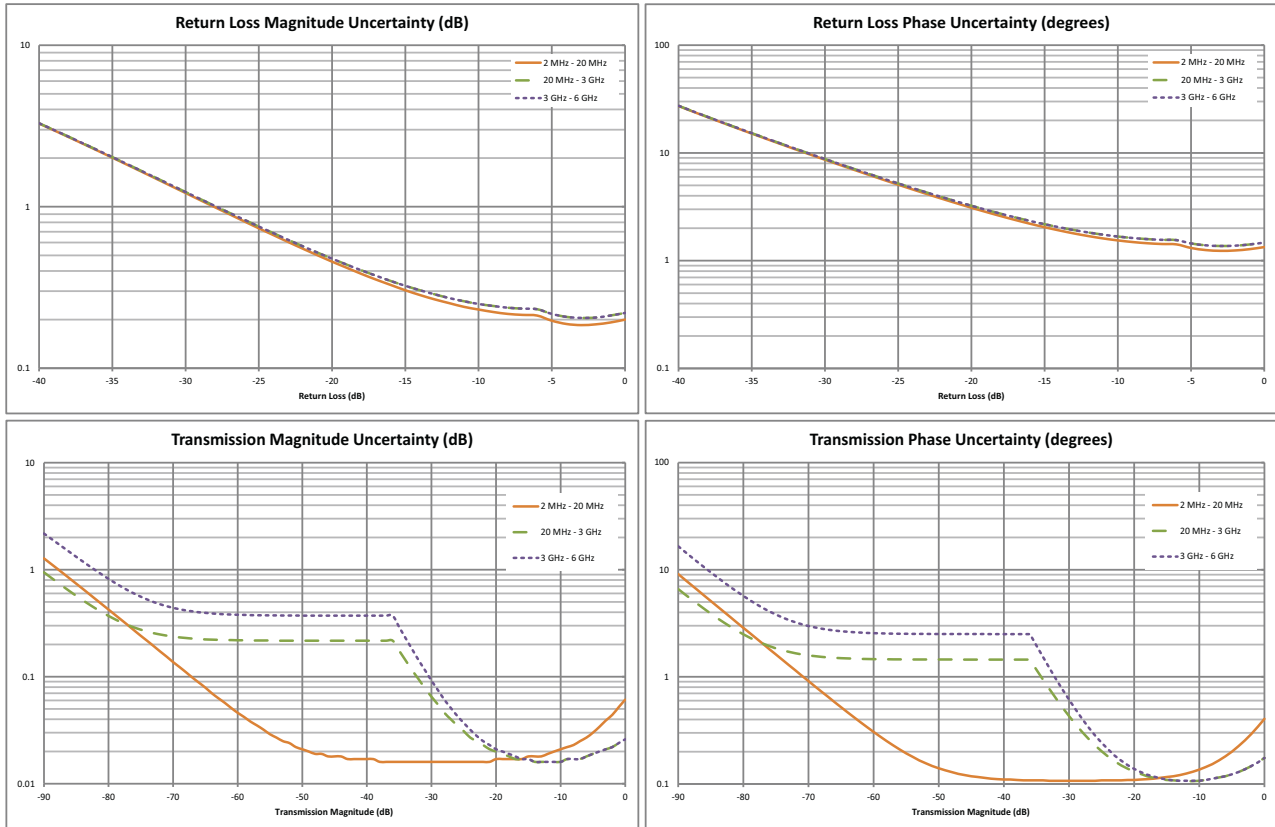

1. Full 1-path, 2-port forward path calibration with isolation, high power, 10 Hz IFBW, no averaging, 10 minute warm-up. OSLN50A-8, OSLNF50A-8, TOSLN50A-8, or TOSLNF50A-8 calibration kit. Reflection and Transmission Tracking are typical.

Corrected System Performance and Uncertainties — High Port Power, K-Type

Measurement Accuracy¹ TOSLK50A-20 or TOSLKF50A-20. Compatible with 3.5 mm and SMA connectors.

Frequency Range	Directivity (dB)	Source Match (dB)	Reflection Tracking (dB)	Transmission Tracking (dB)
< 20 MHz	≥ 42	≥ 33	± 0.01	± 0.01
20 MHz to < 3 GHz	≥ 42	≥ 33	± 0.05	± 0.01
3 GHz to 6 GHz	≥ 42	≥ 33	± 0.05	± 0.01

Corrected Measurement Uncertainty (Transmission from Port 1 to Port 2)

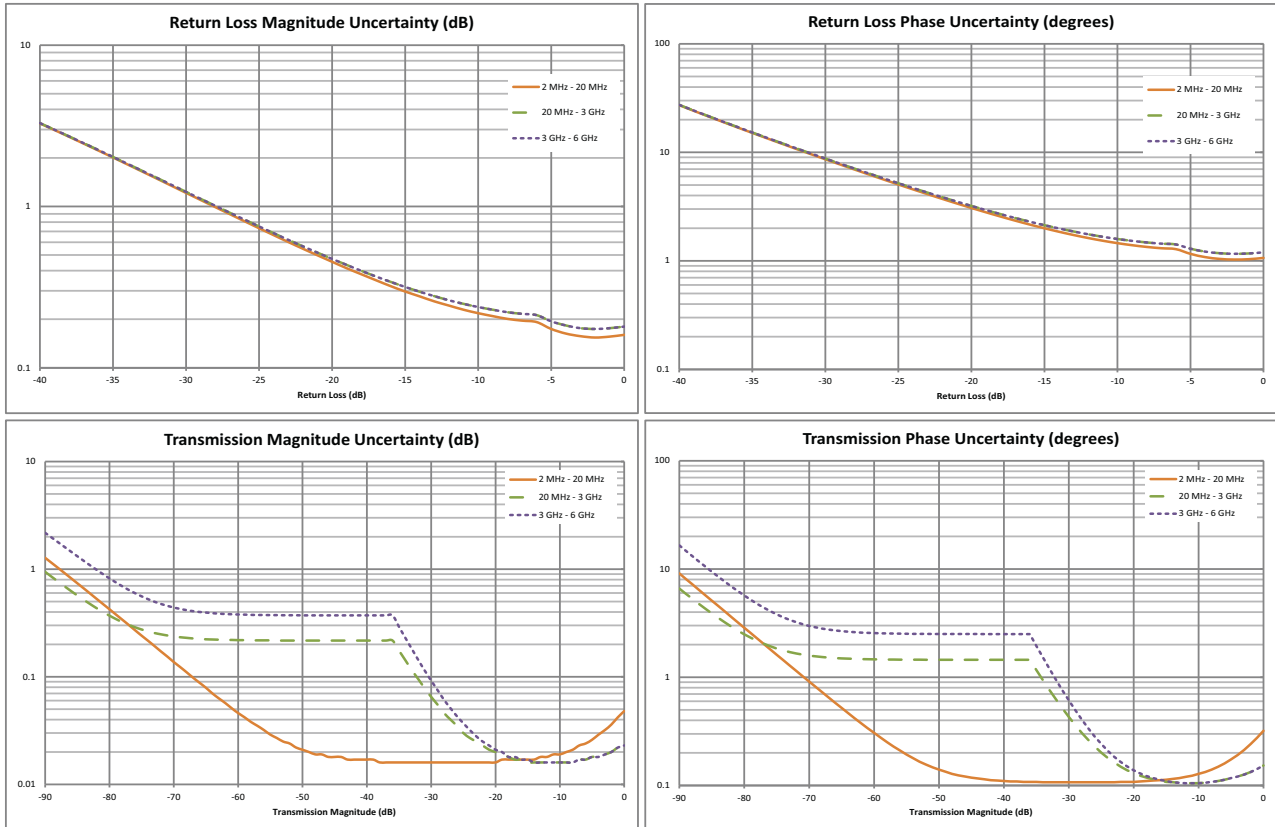

1. Full 1-path, 2-port forward path calibration with isolation, high power, 10 Hz IFBW, no averaging, 10 minute warm-up. TOSLK50A-20, TOSLKF50A-20 calibration kit. Reflection and Transmission Tracking are typical.



Spectrum Analyzer Performance Specifications (Models MS203xB only)

Measurements

Smart Measurements	Field Strength (Uses antenna calibration tables to measure dBm/m ² , dBmV/m, dBV/m, dBμV/m, Volt/m, Watt/m ² , dBW/m ² , A/m, dBA/m and Watt/cm ²) Occupied Bandwidth (Measures 99 % to 1 % power channel of a signal) Channel Power (Measures the total power in a specified bandwidth) ACPR (Adjacent Channel Power Ratio) AM/FM/SSB Demodulation (Wide/narrow FM, USB and LSB), (audio out only) C/I (Carrier-to-interference ratio) Emission Mask Coverage Mapping (requires Option 431) PIM Alert Application (Available for download) PIM Hunting
--------------------	---------------------------------------------------------------------------------------------------------------------------------------------------------------------------------------------------------------------------------------------------------------------------------------------------------------------------------------------------------------------------------------------------------------------------------------------------------------------------------------------------------------------------------------------------------------------------------------------------------------------------------

Setup Parameters

Frequency	Center/Start/Stop, Span, Frequency Step, Signal Standard, Channel #, Channel Increment
Amplitude	Reference Level (RL), Scale, Attenuation Auto/Level, RL Offset, Pre-Amp On/Off, Detection
Span	Span, Span Up/Down (1-2-5), Full Span, Zero Span, Last Span
Bandwidth	RBW, Auto RBW, VBW, Auto VBW, RBW/VBW, Span/RBW
File	Save, Save-on-Event, Recall, Copy, Delete
Save-on-Event	Save, Measurements, Screen Shots (JPEG), Limit Lines, Spurious Emission Mask
Recall	Crossing Limit Line, Sweep Complete, Save-then-Stop, Clear All
Copy	Setups, Measurements, Limit Lines, Spurious Emission Mask
Delete	Selected file or files to internal/external memory (USB)
Application Options	Selected file or files from internal/external memory (USB) Bias-Tee (On/Off), Impedance (50 Ω, 75 Ω, Other)

Sweep Functions

Sweep	Single/Continuous, Sweep Mode (Fast, Performance, No FFT), Reset, Detection, Minimum Sweep Time, Trigger Type, Gated Sweep (see Option 90)
Detection	Peak, RMS, Negative, Sample, Quasi-peak
Triggers	Free Run, External, Video, Change Position, Manual

Trace Functions

Traces	Up to three Traces (A, B, C), View/Blank, Write/Hold, Trace A/B/C Operations
Trace A Operations	Normal, Max Hold, Min Hold, Average, # of Averages, (always the live trace)
Trace B Operations	A → B, B ↔ C, Max Hold, Min Hold
Trace C Operations	A → C, B ↔ C, Max Hold, Min Hold, A - B → C, B - A → C, Relative Reference (dB), Scale

Marker Functions

Markers	Markers 1-6 each with a Delta Marker, or Marker 1 Reference with Six Delta Markers, Marker Table (On/Off), All Markers Off
Marker Types	Style (Fixed/Tracking), Noise Marker, Frequency Counter Marker
Marker Auto-Position	Peak Search, Next Peak (Right/Left), Peak Threshold %, Set Marker to Channel, Marker Frequency to Center, Delta Marker to Span, Marker to Reference Level
Marker Table	1-6 markers frequency and amplitude plus delta markers frequency amplitude and offset

Limit Line Functions

Limit Lines	Upper/Lower, On/Off, Edit, Move, Envelope, Advanced, Limit Alarm, Default Limit
Limit Line Edit	Frequency, Amplitude, Add Point, Add Vertical, Delete Point, Next Point Left/Right
Limit Line Move	To Current Center Frequency, By dB or Hz, To Marker 1, Offset from Marker 1
Limit Line Envelope	Create Envelope, Update Amplitude, Points (41 max), Offset, Shape Square/Slope
Limit Line Advanced	Type (Absolute/Relative), Mirror, Save/Recall

Frequency

Frequency Range	9 kHz to 4 GHz (MS2034B), 9 kHz to 6 GHz (MS2035B) (tunable to 0 Hz)
Tuning Resolution	1 Hz
Frequency Reference	Aging: ± 1.0 ppm/year Accuracy: ± 1.5 ppm (25 °C ± 25 °C) + aging, < ± 50 ppb with GPS On
Frequency Span	10 Hz to 4 GHz including zero span (MS2034B), 10 Hz to 6 GHz including zero span (MS2035B)
Sweep Time	Minimum 100 ms, 7 μs to 3600 s in zero span
Sweep Time Accuracy	± 2 % in zero span

Bandwidth

Resolution Bandwidth (RBW)	10 Hz to 3 MHz in 1-3 sequence ± 10% (1 MHz max in zero-span) (-3 dB bandwidth)
Video Bandwidth (VBW)	1 Hz to 3 MHz in 1-3 sequence (-3 dB bandwidth) (auto or manually selectable)
RBW with Quasi-Peak Detection	200 Hz, 9 kHz, 120 kHz (-6 dB bandwidth)
VBW with Quasi-Peak Detection	Auto VBW is On, RBW/VBW = 1



Spectrum Analyzer Functional Specifications (Models MS203xB only)

Spectral Purity

SSB Phase Noise @ 1 GHz -100 dBc/Hz, -110 dBc/Hz typical @ 10 kHz offset
 -105 dBc/Hz, -112 dBc/Hz typical @ 100 kHz offset
 -115 dBc/Hz, -121 dBc/Hz typical @ 1 MHz offset

Amplitude Ranges

Dynamic Range > 102 dB (2.4 GHz), 2/3 (TOI-DANL) in 1 Hz RBW
 Measurement Range DANL to +26 dBm (≥ 50 MHz)
 DANL to 0 dBm (< 50 MHz)
 Display Range 1 dB to 15 dB/div in 1 dB steps, ten divisions displayed
 Reference Level Range -150 dBm to +30 dBm
 Attenuator Range 0 dB to 55 dB in 5 dB steps
 Maximum Continuous Input +30 dBm
 Amplitude Units Log Scale Modes: dBW, dBm, dBμW, dBV, dBmV, dBμV, dBA, dBmA, dBμA
 Linear Scale Modes: nV, μV, mV, V, kV, nW, μW, mW, W, kW, nA, μA, mA, A

Amplitude Accuracy

9 kHz to 100 kHz ± 2.0 dB typical (Preamp Off)
 100 kHz to 4.0 GHz ± 1.25 dB, ± 0.5 dB typical
 > 4.0 GHz to 6 GHz ± 1.50 dB, ± 0.5 dB typical

Displayed Average Noise Level (DANL)

(RBW Normalized to 1 Hz, 0 dB attenuation)	Preamp Off (Reference Level -20 dBm)		Preamp On (Reference Level -50 dBm)	
	Maximum	Typical	Maximum	Typical
10 MHz to 2.4 GHz	-141 dBm	-146 dBm	-157 dBm	-162 dBm
> 2.4 GHz to 4 GHz	-137 dBm	-141 dBm	-154 dBm	-159 dBm
> 4 GHz to 5 GHz	-134 dBm	-138 dBm	-150 dBm	-155 dBm
> 5 GHz to 6 GHz	-126 dBm	-131 dBm	-143 dBm	-150 dBm

Spurs

Residual Spurious < -90 dBm (RF input terminated, 0 dB input attenuation, > 10 MHz)
 Input-Related Spurious < -75 dBc (0 dB attenuation, -30 dBm input, span < 1.7 GHz, carrier offset > 4.5 MHz)
 Exceptions, typical < -70 dBc @ <2.5 GHz, with 2072.5 MHz Input
 < -68 dBc @ F1 - 280 MHz with F1 Input
 < -70 dBc @ F1 + 190.5 MHz with F1 Input
 < -52 dBc @ 7349 - (2F2) MHz, with F2 Input, where F2 < 2437.5 MHz
 < -55 dBc @ 190.5 ± (F1/2) MHz, F1 < 1 GHz

Third-Order Intercept (TOI)

Preamp Off (-20 dBm tones 100 kHz apart, 10 dB attenuation)
 800 MHz +16 dBm
 2400 MHz +20 dBm
 200-2200 MHz +25 dBm, typical
 > 2.2 GHz to 5.0 GHz +28 dBm, typical
 > 5.0 GHz to 6.0 GHz +33 dBm, typical

Second Harmonic Distortion

Preamp Off, 0 dB input attenuation, -30 dBm input
 50 MHz -56 dBc
 > 50 MHz to 200 MHz -60 dBc, typical
 > 200 MHz to 3000 MHz -70 dBc, typical

VSWR

2:1, typical



Bias Tee (Option 10)

Bias Tee Measurements

For tower mounted amplifier tests, the MS202xB/MS203xB series with optional internal bias tees can supply both DC and RF signals on the center conductor of the cable during measurements. For frequency sweeps in excess of 2 MHz, the VNA Master can supply internal voltage control from +12 to +32 V in 0.1 V steps up to 450 mA. Bias can be directed to VNA Port 2 or to the Spectrum Analyzer Input Port (MS203xB).

Bias Tee Specifications

Frequency Range	
MS20x4B	2 MHz to 4 GHz
MS20x5B	2 MHz to 6 GHz
Internal Voltage/Current	+12 V to +32 V at 450 mA (1 A surge for 100 ms)
Internal Resolution	0.1 V
Bias Tee Selections	Internal, Off

The Compact VNA Master offers optional integrated bias tee for supplying DC plus RF to the DUT as shown in this simplified block diagram.

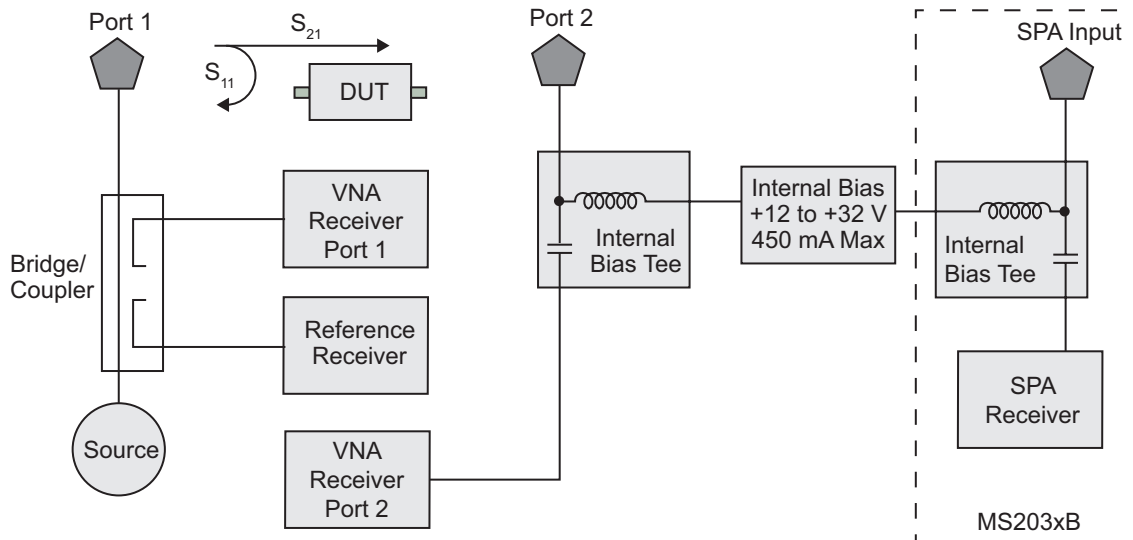

Vector Voltmeter (Option 15)

A phased array system relies on phase matched cables for nominal performance. For this class of application, the VNA Master offers this special software mode to simplify phase matching cables at a single frequency. The similarity between the popular vector voltmeter and this software mode ensures minimal training is required to phase match cables. Operation is as simple as configuring the display for absolute or relative measurements. The easy-to-read large fonts show either reflection or transmission measurements using impedance, magnitude, or VSWR readouts. For instrument landing system (ILS) or VHF Omnidirectional Range (VOR) applications, a table view improves operator efficiency when phase matching up to twelve cables. The MS202xB/MS203xB solution is superior because the signal source is included internally, precluding the need for an external signal generator.

VVM Specifications

CW Frequency Range	500 kHz to 4/6 GHz
Source Power	High, Default, Low
IFBW	10 Hz to 100 kHz in 1-2-5 sequence
Measurement Display	CW, Table (twelve entries, plus reference)
Measurement Types	Return Loss, Insertion
Measurement Format	dB/VSWR/Impedance



Distance Domain (Formerly Option 501, now standard with firmware v1.20 or greater)

Distance-to-Fault Analysis (standard with firmware v1.20 and above) is a powerful field test tool to analyze cables for faults, including minor discontinuities that may occur due to a loose connection, corrosion, or other aging effects. By using Frequency Domain Reflectometry (FDR), the Compact VNA Master exploits a user-specified band of full power operational frequencies (instead of DC pulses from TDR approaches) to more precisely identify discontinuities. The Compact VNA Master converts S-parameters from frequency domain into distance domain on the horizontal display axis, using a mathematical computation called Inverse Fourier Transform. Connect a reflection at the opposite end of the cable, and the discontinuities appear versus distance to reveal any potential maintenance issues. When access to both ends of the cable is convenient, a similar distance domain analysis is available on transmission measurements.

Distance Domain, will improve your productivity with displays of the cable in terms of discontinuities versus distance. This readout can then be compared against previous measurements (from stored data) to determine whether any degradations have occurred since installation (or the last maintenance activity). More importantly, you will know precisely where to go to fix the problem and so minimize or prevent downtime of the system.



High Accuracy Power Meter (Option 19) (Requires external USB power sensor, sold separately)

Amplitude	Maximum, Minimum, Offset, Relative On/Off, Units, Auto Scale				
Average	# of Running Averages, Max Hold				
Zero/Cal	Zero On/Off, Cal Factor (Center Frequency, Signal Standard)				
Limits	Limit On/Off, Limit Upper/Lower				
Power Sensor Model	MA24105A	MA24106A	MA24108A/18A/26A	MA24208A/18A	MA24330A/40A/50A
Description	Inline High Power Sensor	High Accuracy RF Power Sensor	Microwave USB Power Sensor	Microwave Universal USB Power Sensor	Microwave CW USB Power Sensor
Frequency Range	350 MHz to 4 GHz	50 MHz to 6 GHz	10 MHz to 8/18/26 GHz	10 MHz to 8/18 GHz	10 MHz to 33/40/50 GHz
Connector	Type N(f), 50 Ω	Type N(m), 50 Ω	Type N(m), 50 Ω (8/18 GHz) Type K(m), 50 Ω (26 GHz)	Type N(m), 50 Ω	Type K(m), 50 Ω (33/40 GHz) Type V(m), 50 Ω (50 GHz)
Dynamic Range	+3 dBm to +51.76 dBm (2 mW to 150 W)	-40 dBm to +23 dBm (0.1 μW to 200 mW)	-40 dBm to +20 dBm (0.1 μW to 100 mW)	-60 dBm to +20 dBm (1 nW to 100 mW)	-70 dBm to +20 dBm (0.1 nW to 100 mW)
Measurand	True-RMS	True-RMS	True-RMS, Slot Power, Burst Average Power	True-RMS, Slot Power, Burst Average Power	Average Power
Measurement Uncertainty	± 0.17 dB ^a	± 0.16 dB ^b	± 0.18 dB ^c	± 0.17 dB ^d	± 0.17 dB ^e
Data sheet (for complete specifications)	11410-00621	11410-00424	11410-00504	11410-00841	11410-00906

- Notes:
- a. Expanded uncertainty with K=2 for power measurements of a CW signal greater than +20 dBm with a matched load. Measurement results referenced to the input side of the sensor.
 - b. Total RSS measurement uncertainty (0 °C to 50 °C) for power measurements of a CW signal greater than -20 dBm with zero mismatch errors.
 - c. Expanded uncertainty with K=2 for power measurements of a CW signal greater than -20 dBm with zero mismatch errors.
 - d. Power uncertainty expressed with two sigma confidence level for CW measurement after zero operation. Includes calibration factor and linearity over temperature uncertainties, but not the effects of mismatch, zero set and drift, or noise.
 - e. Includes linearity over temperature uncertainties, but not the effects of calibration factor, mismatch, zero set and drift, and noise.



Interference Analyzer (Option 25) (Models MS203xB only, GPS Option 31 recommended)

Measurements

Spectrum	Field Strength Occupied Bandwidth Channel Power Adjacent Channel Power (ACPR) AM/FM/SSB Demodulation (Wide/Narrow FM, Upper/Lower SSB - audio out only) Carrier-to-Interference ratio (C/I)
Spectrogram	Collect data up 72 hours
Signal Strength	Gives visual and aural indication of signal strength
Received Signal Strength Indicator (RSSI)	Collect data up to 168 hours (one week)
Signal ID	Up to 12 signals Center Frequency Bandwidth Signal Type: FM, GSM, W-CDMA, CDMA, Wi-Fi Closest Channel Number Number of Carriers
Signal-to-Nose Ratio (SNR)	> 10 dB
Interference Mapping	Triangulate location of interference with on-display maps
Application Options	Bias-Tee (On/Off), Impedance (50 Ω, 75 Ω, Other)



Channel Scanner (Option 27) (Models MS203xB only, GPS Option 31 recommended)

General

Number of Channels	1 to 20 Channels
Measurements	Graph/Table, Max Hold (On/5 s/Off), Freq/Channel, Current/Max, Single/Dual Color
Scanner	Scan Channels, Scan Frequencies, Scan Customer List, Scan Script Master™
Amplitude	Reference Level, Scale
Custom Scan	Signal Standard, Channel, # of Channels, Channel Step Size, Custom Scan
Frequency Range	9 kHz to 4 GHz (MS2034B), 9 kHz to 6 GHz (MS2035B)
Frequency Accuracy	± 10 Hz + Time base error
Measurement Range	-110 dBm to +26 dBm
Application Options	Bias-Tee (On/Off), Impedance (50 Ω, 75 Ω, Other)



GPS (Option 31) (requires external GPS antenna, sold separately)

Built-in GPS provides location information (latitude, longitude, altitude) and Universal Time (UT) information for storage along with trace data so that you can later verify that measurements were taken at the right location. The GPS option requires a separately ordered Anritsu GPS antenna. Frequency accuracy is enhanced for the Spectrum Analyzer (on MS203xB models) when GPS is active and has achieved satellite lock.

GPS Specifications

Setup	On/Off, Antenna Voltage 3.3/5.0 V, GPS Info
GPS Time/Location Indicator	Time, Latitude, Longitude and Altitude on display Time, Latitude, Longitude and Altitude with trace storage
High Frequency Accuracy	Spectrum Analyzer, Interference Analyzer, CW Signal Analyzers < ± 50 ppb with GPS On, GPS antenna connected, 3 minutes after satellite lock in selected mode
Connector	SMA, Female



Coverage Mapping (Option 431) (Models MS203xB only. Requires GPS)

Measurements

Indoor Mapping	RSSI and ACPR
Outdoor Mapping	RSSI and ACPR

Setup Parameters

Frequency	Center/Start/Stop, Span, Freq Step, Signal Standard, Channel #, Channel Increment
Amplitude	Reference Level (RL), Scale, Attenuation Auto/Level, RL Offset, Pre-Amp On/Off, Detection
Span	Span, Span Up/Down (1-2-5), Full Span, Zero Span, Last Span
BW	RBW, Auto RBW, VBW, Auto VBW, RBW/VBW, Span/VBW
Measurement Setup	ACPR, RSSI
Point Distance / Time Setup	Repeat Type Time Distance
Save Points Map	Save KML, JPEG, Tab Delimited
Recall Points Map	Recall Map, Recall KML Points only, Recall KML Points with Map, Recall Default Grid

Ethernet Connectivity

(Formerly Option 411)

Connector	RJ45
LAN Speed	10 Mbps
Mode	Static, DHCP
Static IP settings	IP address, Subnet Mask, IP Gateway
Remote Control	Fully remote programmable via SCPI commands and/or remote access utility provided with Master Software Tools
Data Upload	With Line Sweep Tools or Master Software Tools through a LAN connection



AM/FM/PM Demodulation Analyzer (Option 509) (Models MS203xB only)

Measurements

Display Type	RF Spectrum (AM/FM/PM)	Audio Spectrum (AM)	Audio Spectrum (FM/PM)	Audio Waveform (AM)	Audio Waveform (FM/PM)	Summary (AM)	Summary (FM/PM)
Graphic Display	Power (dBm) vs. Frequency	Depth (%) vs. Modulation Frequency	Deviation (kHz/rad) vs. Modulation Frequency	Depth (%) vs. Time	Deviation (kHz/rad) vs. Time	None	None
Numerical Displays	Carrier Power Carrier Frequency Occupied BW	AM Rate RMS Depth (Pk-Pk)/2 Depth SINAD* THD* Distortion/Total Vrms*	FM/PM Rate RMS Deviation (Pk-Pk)/2 Deviation SINAD* THD* Distortion/Total Vrms*	AM Rate RMS Depth (Pk-Pk)/2 Depth SINAD* THD* Distortion/Total Vrms*	FM/PM Rate RMS Deviation (Pk-Pk)/2 Deviation SINAD* THD* Distortion/Total Vrms*	RMS Depth (AM) Peak + Depth Peak - Depth (Pk-Pk)/2 Depth Carrier Power Carrier Frequency Occupied Bandwidth AM Rate SINAD* THD* Distortion/Total Vrms*	RMS Deviation (FM/PM) Peak + Depth Peak - Depth (Pk-Pk)/2 Depth Carrier Power Carrier Frequency Occupied Bandwidth AM Rate SINAD* THD* Distortion/Total Vrms*

* Requires Sinewave modulation

Setup Parameters

Frequency	Center Freq, Span, Freq Step, Signal Standard, Channel, Channel Increment, Set Carrier Freq
Amplitude	Scale, Power Offset, Adjust Range
Setup	Demod Type (AM, FM, PM), IFBW, Auto IFBW
Measurements	RF Spectrum AM/FM/PM, Audio Spectrum (AM/FM/PM), Audio Waveform (AM/FM/PM), Summary (AM/FM/PM), Average
Marker	On/Off, Delta, Peak Search, Marker Freq to Center, Marker to Ref Lvl, Marker Table, All Markers Off

Specifications

AM	Modulation Rate: ± 1 Hz (< 100 Hz); $\pm 2\%$ (> 100 Hz) Depth: $\pm 5\%$ for (Modulation rates 10 Hz to 100 kHz)
FM	Modulation Rate: ± 1 Hz (< 100 Hz); $\pm 2\%$ (100 Hz to 100 kHz) Deviation Accuracy: $\pm 5\%$ (100 Hz to 100 kHz)**
PM	Modulation Rate: ± 1 Hz (< 100 Hz); $\pm 2\%$ (100 Hz to 100 kHz) Deviation Accuracy: $\pm 5\%$ (deviation 0 to 93 rad, rate 10 Hz to 5 kHz)**
IF bandwidth	1 kHz to 300 kHz in 1-3 sequence
Frequency Span	RF Spectrum: 10 kHz to 10 MHz Audio Spectrum: 2 kHz, 5 kHz, 10 kHz, 20 kHz, 70 kHz, 140 kHz
RBW/VBW	30
Span/RBW	100
Sweep time	50 μ s to 50 ms (Audio Waveform)
**	IFBW must be greater than 95 % occupied BW



General Specifications

Maximum Input		(Damage Level)
VNA Port 1 or 2		+23 dBm, \pm 50 VDC
Spectrum Analyzer Port		+30 dBm peak, \pm 50 VDC, Maximum Continuous Input, \geq 10 dB attenuation (Models MS203xB, spectrum analyzer input port only)
System Parameters		
System		Status (Temperature, Battery Info, Serial Number, Firmware Version, Options Installed) Self Test, Application Self Test GPS (see Option 31)
System Options		Name, Date and Time, Ethernet Configuration, Brightness, Volume, Language (English, French, German, Spanish, Chinese, Japanese, Korean, Italian, Russian, Portuguese), Reset (Factory Defaults, Master Reset, Update Firmware)
Internal Trace/Setup Memory		2000 traces, 2000 setups
External Trace/Setup Memory		Limited by size of USB Flash drive
Mode Switching		Auto-Stores/Recalls most recently used Setup Parameters in the Mode
File Management		
File Types		Vary with measurement mode
File		Save, Recall, Copy, Delete
Save		Setups, Measurements, Screen Shots (JPEG)
Recall		Setups, Measurements
Copy		Selected file or files to internal/external memory (USB)
Delete		Selected file or files from internal/external memory (USB)
File Sort Method		By Name/Date/Type, Ascend/Descend
Connectors		
VNA Port 1 or 2		Type N, female, 50 Ω
Spectrum Analyzer Port		Type N, female, 50 Ω (MS203xB only)
GPS		SMA, female
External Power		5.5 mm barrel connector, 12.5 VDC to 15 VDC, < 4.0 Amps
USB Interface (2)		Type A, Connect Flash Drive and Power Sensor
USB Interface		5-pin mini-B, Connect to PC for data transfer
Headset Jack		3.5 mm barrel connector
External Reference In		BNC, female, Maximum Input \pm 5 VDC 1 MHz, 5 MHz, 10 MHz, 13 MHz
External Trigger		BNC, female, Maximum Input \pm 5 VDC
Ethernet		RJ45 connector for Ethernet 10/100-BaseT
Display		
Type		Resistive Touch Screen
Size		8.4 in, daylight viewable color LCD
Resolution		800 x 600
Pixel Defects		No more than five defective pixels (99.9989% good pixels)
Power		
Field replaceable battery		Li-Ion, 633-75, 7500 mAh 40 W on battery power only
DC Power		Universal 110/220 V AC/DC Adapter 55 W running off AC/DC adaptor while charging battery
Life time charging cycles		> 300 (80 % of initial capacity)
Battery Operation		3.6 hours, typical
Battery Charging Limits		0 $^{\circ}$ C to +45 $^{\circ}$ C, Relative Humidity \leq 80 %



General Specifications (continued)

Regulatory Compliance

European Union	EMC 2014/30/EU, EN 61326-1:2013 CISPR 11/EN 55011, IEC/EN 61000-4-2/3/4/5/6/8/11 Low Voltage Directive 2014/35/EU Safety EN 61010-1:2010 RoHS Directive 2011/65/EU + 2015/863
United Kingdom	EMC SI 2016/1091; BS EN 55011 & BS 61000-4-2/3/4/5/6/8/11 Consumer Protection (Safety) SI 2016/1101; BS EN 61010-1:2010 Environmental Protection SI 2012/3032; 2011/65/EU & 2015/863
Australia and New Zealand	RCM AS/NZS 4417:2012
South Korea	KCC-REM-A21+-0004
Canada	ICES-1(A)/NMB-1(A)

Environmental

	MIL-PRF-28800F Class 2
Operating Temperature Range	-10 °C to 55 °C
Storage Temperature Range	-51 °C to 71 °C
Maximum Relative Humidity	95 % RH at 30 °C, non-condensing
Vibration, Sinusoidal	5 Hz to 55 Hz
Vibration, Random	10 Hz to 500 Hz
Half Sine Shock	30 g _n
Altitude	4600 meters, operating and non-operating
Explosive Atmosphere	MIL-PRF-28800F Section 4.5.6.3 MIL-STD-810G, Method 511.5, Procedure 1

Size and Weight

Dimensions	273 mm x 199 mm x 91 mm (10.7 in x 7.8 in x 3.6 in)
Weight, Including Battery	3.5 kg (7.6 lb)

Warranty

Duration	Standard three-year warranty (battery one-year warranty)
----------	----------------------------------------------------------



Line Sweep Tools (for your PC)

Trace Capture		
Browse to Instrument		View and copy traces from the test equipment to your PC using Windows Explorer
Open Legacy Files		Open DAT files captured with Hand Held Software Tools v6.61
Open Current Files		Open VNA or DAT files
Capture plots To		The Line Sweep Tools screen, DAT files, Database, or JPEG
Traces		
Trace Types		Return Loss, VSWR, DTF-RL, DTF-VSWR, Cable Loss, and Smith Chart
Trace Formats		DAT, VNA, CSV, PNG, BMP, JPG, HTML, Data Base, and PDF
Report Generation		
Report Generator		Includes GPS location along with measurements
Report Format		Create reports in HTML or PDF format
Report Setup		Report Title, Company, Prepared for, Location, Date and Time, Filename, Company logo
Trace Setup		1 trace Portrait Mode, 2 Trace Portrait Mode, 1 Trace Landscape Mode
Trace Validation		
Presets		7 presets allow "one click" setting of up to 6 markers and one limit line
Marker Controls		6 regular Markers, Marker Peak, Marker valley, Marker between, and frequency entry
Delta Markers		6 Delta markers
Limit Line		Enable and drag or value entry. Also works with presets
Next Trace Button		Next Trace and Previous trace arrow keys allow quick switching between traces
Tools		
Cable Editor		Allows creation of custom cable parameters
Distance to Fault		Converts a Return Loss trace to a Distance to Fault trace
Measurement Calculator		Converts Real, Imaginary, Magnitude, Phase, RL, VSWR, Rho, and Transmit power
Signal Standard Editor		Creates new band and channel tables
Renaming Grid		36 user definable phrases for creation of file names, trace titles, and trace subtitles
Connectivity		
Connections		Ethernet, USB cable, USB Memory Stick



Master Software Tools (for your PC)

Measurement Viewing		
Display		Modify display settings, including scale
Spectrum Traces		Add, delete, and modify limit lines and markers. Overlay traces.
Spectrum Analyzer Measurements		Field Strength, Occupied Bandwidth, Channel Power, ACPR, Emission Mask, C/I ¹
Interference Analyzer Measurements		Spectrograms, Signal Strength Meter, RSSI ²
Non-Spectrum Measurements		Hi Accuracy Power Meter, Channel Scanner, GSM, WCDMA/HSPA, LTE, TD-LTE, TD-SCDMA, CDMA, EV-DO, Fixed WiMAX, Mobile WiMAX, Screen captures (JPEGs)
		1. Spurious Emissions results viewable in a browser
		2. Coverage Mapping and Interference Mapping files viewable in spreadsheet, Google Earth, or Google Maps
Database Management		
Full Trace Retrieval		Retrieve all traces from instrument into one PC directory (limited to approximately 15,000 files)
Trace Catalog		Index all traces in selected folder & subfolder on PC into one catalog
Trace Rename Utility		Rename measurement traces
Group Edit		Titles, subtitles, plot scaling, markers and limit lines, simultaneously on similar files
Data Analysis		
Trace Math and Smoothing		Compare multiple traces
Measurement Calculator		Translate into other units
Report Generation		
Report Generator		Includes GPS, power level, and measurements
Edit Graph		Change scale, limit lines, and markers
Report Format		Create reports in HTML
Export Measurements		Export measurements or entire folders to *.jpg or *.csv format
Notes		Annotate measurements
Mapping (GPS required on instrument)		
Spectrum Analyzer Mode		MapInfo, MapPoint
Mobile WiMAX OTA, LTE OTA Options		Google Earth, Google Maps, MapInfo

Spectrogram (Spectrum Monitoring for Interference Analysis and Spectrum Clearing)

Source	Recorded Spectrogram or multiple spectrum traces
Folder Spectrogram	2D View creates a composite file of multiple traces
Available Displays	Spectrogram, Peak Power vs. Time, Variation in Total Power vs. Time, Peak Frequency vs. Time, Number of Traces Saved vs. Time (useful with Save on Limit Exceeded), Maximum/Average/Minimum Power vs. Time
	File Filter (Violations over limit lines or deviations from averages)
	Playback
Display Functions per Trace	Markers, GPS location altitude and time (when recorded), instrument time
	Filename per trace for Folder Spectrogram
Export to Video	Create AVI file of 2D Spectrogram for management review/reports
Export to 3D Spectrogram	Views (Set Threshold, Markers)
	- 3D (Rotate X, Y, Z Axis, Level Scale, Signal ID)
	- 2D (Frequency or Time Domain, Signal ID)
	- Top Down
	Playback (Frequency and/or Time Domain)

List/Parameter Editors

Antennas, Cables, Signal Standards	Modify instrument's Antenna, Cable, and Signal Standard List
Pass/Fail	Create, download, or edit Signal Analysis Pass/Fail Limits
Script Master	Create Script Master files for GSM/WCDMA or Channel Scanner
Languages	Modify non-English language menus
Mobile WIMAX	DL-MAP Parameters

Connectivity

Connections	Connect to PC using USB, LAN, or Direct Ethernet connection
Network Search	Find all Anritsu handheld instruments on local network
Download	Download measurements and live traces to PC for storage and analysis
Upload	Upload measurements and other files from PC to instrument
Export	Measurements can be saved in various formats, depending on the measurement type, including JPEG, CSV, and Anritsu DAT format
Printing	Print individual or all measurement screens

Web Remote Control









Control	Full instrument control through a browser – all instrument functions except power switch and rotary knob
Connections	RJ45 Ethernet jack Third party Wi-Fi router
Protocol	HTTP/TCP/IP
Physical Layer	Cat 5 Cable, Wi-Fi router compatible
Software Required	HTML 5-compliant browser – Google Chrome, Mozilla Firefox
Operating System	iOS, Windows, Linux, Android operating systems that can host the HTML 5-compliant browser
Remote Hardware	PCs, tablets, and smart phones with Ethernet or Wi-Fi connection and an HTML 5-compliant browser
Download	Individual instrument files downloaded via browser Multiple instrument files and directories zipped and downloaded via browser File downloads are not supported by iOS Screen capture capability
Display Modes	Normal: All modes & displays supported Fast: Spectrogram traces update faster (up to 5 updates per second)
Password	The instrument can be password protected Passwords may be used to manage who is controlling the instrument
Users/Instruments	One user/device can view and control many instruments

Programmable Remote Control

Functionality	Many instrument functions are programmable. See the Programming Manual for details.
Programming Language	Standard Commands for Programmable Instruments (SCPI)
Interfaces	USB, Ethernet
Available Drivers	LabView. Visit NI.com for driver

Ordering Information

VNA Master Handheld Vector Network Analyzer + Spectrum Analyzer

	MS2024B	MS2025B	MS2034B	MS2035B	Description
	500 kHz to 4 GHz	500 kHz to 6 GHz	500 kHz to 4 GHz 9 kHz to 4 GHz	500 kHz to 6 GHz 9 kHz to 6 GHz	Vector Network Analyzer Spectrum Analyzer
	MS2024B-0010	MS2025B-0010	MS2034B-0010	MS2035B-0010	Built-in Bias-Tee, +12 V to +32 V variable
	MS2024B-0015	MS2025B-0015	MS2034B-0015	MS2035B-0015	Vector Voltmeter
	MS2024B-0019	MS2025B-0019	MS2034B-0019	MS2035B-0019	High Accuracy Power Meter (requires external USB sensor, sold separately)
			MS2034B-0025	MS2035B-0025	Interference Analyzer ^a
			MS2034B-0027	MS2035B-0027	Channel Scanner ^a
	MS2024B-0031	MS2025B-0031	MS2034B-0031	MS2035B-0031	GPS Receiver ^b
	MS2024B-0098	MS2025B-0098	MS2034B-0098	MS2035B-0098	Standard Calibration to ISO17025 and ANSI/NCSL Z540-1. Includes calibration certificate.
	MS2024B-0099	MS2025B-0099	MS2034B-0099	MS2035B-0099	Premium Calibration to ISO17025 and ANSI/NCSL Z540-1. Includes calibration certificate, test report, and uncertainty data.
			MS2034B-0431	MS2035B-0431	Coverage Mapping ^c
			MS2034B-0509	MS2035B-0509	AM/FM/PM Demodulation Analyzer

a. GPS Option 31 recommended.

b. Requires external GPS antenna (sold separately).







c. Requires GPS Option 31.





Standard Accessories (included with instrument)

Accessory	Description
	2000-1654-R Soft Carrying Case
	2000-1691-R Stylus with Coiled Tether
	633-75 Li-Ion Battery
	40-187-R AC-DC Adapter with AC power cord (country dependent)
Certificate of Calibration and Conformance	

Accessory	Description
	2000-1371-R Ethernet Cable, 2.1 m (7 ft)
	3-2000-1498 USB A/5-pin mini-B Cable, 10 ft
	806-141-R Automotive Power Adapter, 12 VDC, 60 W
	2000-1797-R Screen Protector Film (x2, one factory installed, one spare)



USB Power Sensors (for complete ordering information, see the respective data sheets of each sensor)

Accessory	Description
	MA24330A Microwave CW USB Power Sensor, 10 MHz to 33 GHz, +20 dBm
	MA24340A Microwave CW USB Power Sensor, 10 MHz to 40 GHz, +20 dBm
	MA24350A Microwave CW USB Power Sensor, 10 MHz to 50 GHz, +20 dBm
	MA24208A Microwave Universal USB Power Sensor, 10 MHz to 8 GHz, +20 dBm to -60 dBm
	MA24218A Microwave Universal USB Power Sensor, 10 MHz to 18 GHz, +20 dBm to -60 dBm
	MA24106A High Accuracy RF Power Sensor, 50 MHz to 6 GHz, +23 dBm to -40 dBm

Accessory	Description
	MA24108A Microwave USB Power Sensor, 10 MHz to 8 GHz, +20 dBm to -40 dBm
	MA24118A Microwave USB Power Sensor, 10 MHz to 18 GHz, +20 dBm to -40 dBm
	MA24126A Microwave USB Power Sensor, 10 MHz to 26 GHz, +20 dBm to -40 dBm
	MA24105A Inline Dual Directional High Power Sensor, 350 MHz to 4 GHz, +3 dBm to +51.76 dBm
	MA25100A RF Power Indicator

Optional Accessories

Backpack and Transit Case

Accessory	Description
	67135 Anritsu Backpack (for Handheld Instrument and PC)
	760-243-R Large Transit Case with Wheels and Handle 56 cm x 45.5 cm x 26.5 cm (22.07" x 17.92" x 10.42")
	760-286-R Compact Transit Case with Wheels and Handle 55.6 cm x 35.5 cm x 22.9 cm (21.89" x 13.98" x 9.01")

Accessory Description

	760-261-R Large Transit Case with Wheels and Handle 63.1 cm x 50 cm x 30 cm (24.83" x 19.69" x 11.88"), space for MA2700A, antennas, filters, instrument inside soft case, and other interference hunting accessories/tools
	760-262-R Transit Case for MA2700A, holds several Yagi antennas and filters/port extender 96.8 x 40.6 x 15.5 cm (38.12" x 16.00" x 6.12")
	760-271-R Transit Case for Portable Directional Antennas and Port Extender 52.4 cm x 42.8 cm x 20.6 cm (20.62" x 16.87" x 8.12") (for 2000-1777-R, 2000-1778-R, 2000-1779-R, 2000-1798-R)











Miscellaneous Accessories

Accessory	Description
	MA2700A Handheld Interference Hunter (For full specifications, refer to the MA2700A Technical Data Sheet 11410-00692)
	2000-1374-R External Dual Charger for Li-Ion Batteries
	2000-2149-R EMI Near-Field Probe Kit, 100 kHz to 1 GHz Requires 1092-172-R Type N to BNC Adapter and 1 m BNC to BNC Cable (sold separately) (For full specifications, refer to the Near-Field Probe Set User Guide 10580-00347)

Accessory Description

	3-806-152 Cat 5e Crossover Patch Cable, 2.1 m (7 ft)
	66864 Rack Mount Kit, Master Platform

Full Temperature Coaxial Calibration Kits -10 °C to +55 °C, K Type is compatible with 3.5 mm and SMA connectors see individual data sheets on www.anritsu.com)

Accessory	Description	Accessory	Description
	OSLN50A-8 High Performance Type N(m), DC to 8 GHz, 50 Ω		OSLNF50A-8 High Performance Type N(f), DC to 8 GHz, 50 Ω
	OSLN50A-18 High Performance Type N(m), DC to 18 GHz, 50 Ω		OSLNF50A-18 High Performance Type N(f), DC to 18 GHz, 50 Ω
	TOSLN50A-8 High Performance with Through Type N(m), DC to 8 GHz, 50 Ω		TOSLNF50A-8 High Performance with Through Type N(f), DC to 8 GHz, 50 Ω
	TOSLN50A-18 High Performance with Through Type N(m), DC to 18 GHz, 50 Ω		TOSLNF50A-18 High Performance with Through Type N(f), DC to 18 GHz, 50 Ω
	TOSLK50A-20 High Performance with Through Type K(m), DC to 20 GHz, 50 Ω		TOSLKF50A-20 High Performance with Through Type K(f), DC to 20 GHz, 50 Ω

Coaxial Calibration Components, N Type 50 Ω, K Type 50 Ω (K Type is compatible with 3.5 mm and SMA connectors)

Accessory	Description	Accessory	Description
	22N50 Open/Short, N(m), DC to 18 GHz, 50 Ω		22NF50 Open/Short, N(f), DC to 18 GHz, 50 Ω
	28N50-2 Precision Load, N(m), DC to 18 GHz, 50 Ω		28NF50-2 Precision Load, N(f), DC to 18 GHz, 50 Ω
	22K50 Precision Open/Short, K(m), DC to 40 GHz, 50 Ω		22KF50 Precision Open/Short, K(f), DC to 40 GHz, 50 Ω
	28K50 Precision Load, K(m), DC to 40 GHz, 50 Ω		28KF50 Precision Load, K(f), DC to 40 GHz, 50 Ω

Coaxial Calibration Components, Other 50 Ω, 75 Ω

Accessory	Description
	22N75 Open/Short, N(m), DC to 3 GHz, 75 Ω
	26N75A Precision Termination, N(m), DC to 3 GHz, 75 Ω
	12N50-75B Matching Pad, DC to 3 GHz, 50 Ω to 75 Ω
	2000-1619-R Precision Open/Short/Load, 7/16 DIN(f), DC to 6.0 GHz, 50 Ω
	2000-1915-R Precision Open/Short/Load, 4.3-10(m), DC to 6 GHz, 50 Ω
	SM/PLNF-1 Precision N(f) Load, 42 dB, 6 GHz
	1091-53-R Open, TNC(m), DC to 18 GHz
	1091-54-R Short, TNC(m), DC to 18 GHz
	1015-55-R Termination, TNC(m), DC to 18 GHz

Accessory	Description
	22NF75 Open/Short, N(f), DC to 3 GHz, 75 Ω
	26NF75A Precision Termination, N(f), DC to 3 GHz, 75 Ω
	2000-1618-R Precision Open/Short/Load, 7/16 DIN(m), DC to 6.0 GHz, 50 Ω
	2000-1914-R Precision Open/Short/Load, 4.3-10(f), DC to 6 GHz, 50 Ω
	SM/PL-1 Precision N(m) Load, 42 dB, 6 GHz
	1091-55-R Open, TNC(f), DC to 18 GHz
	1091-56-R Short, TNC(f), DC to 18 GHz
	1015-54-R Termination, TNC(f), DC to 18 GHz

Precision Adapters		Accessory	
Accessory	Description	Accessory	Description
	34NN50A N(m) to N(m), DC to 18 GHz, 50 Ω		34NFN50 N(f) to N(f), DC to 18 GHz, 50 Ω
	34NK50 Precision Adapter, DC to 18 GHz, N(m) to K(m), 50 Ω		34NFK50 Precision Adapter, DC to 18 GHz, N(m) to K(f), 50 Ω
	K220B Precision Adapter, DC to 40 GHz, K(m) to K(m), 50 Ω		K222B Precision Adapter, DC to 40 GHz, K(f) to K(f), 50 Ω
	K224B Precision Adapter, DC to 40 GHz, K(m) to K(f), 50 Ω		

Adapters Accessory	Description
	1091-26-R SMA(m) to N(m), DC to 18 GHz, 50 Ω
	1091-27-R SMA(f) to N(m), DC to 18 GHz, 50 Ω
	1091-80-R SMA(m) to N(f), DC to 18 GHz, 50 Ω
	1091-81-R SMA(f) to N(f), DC to 18 GHz, 50 Ω
	1091-172-R BNC(f) to N(m), DC to 1.3 GHz, 50 Ω
	1091-465-R Adapter, DC to 6 GHz, 4.3-10(f) to N(f), 50 Ω
	510-96-R 7/16 DIN(m) to 7/16 DIN (m), DC to 7.5 GHz, 50 Ω
	1091-315-R DC to 18 GHz, TNC(m) to N(f), 50 Ω
	1091-324-R DC to 18 GHz, TNC(f) to N(m), 50 Ω
	1091-317-R DC to 18 GHz, TNC(m) to SMA(f), 50 Ω
	1091-318-R DC to 18 GHz, TNC(m) to SMA(m), 50 Ω

Accessory	Description
	510-102-R N(m) to N(m), DC to 11 GHz, 50 Ω, 90 degrees right angle
	510-90-R 7/16 DIN(f) to N(m), DC to 7.5 GHz, 50 Ω
	510-91-R 7/16 DIN(f) to N(f), DC to 7.5 GHz, 50 Ω
	510-92-R 7/16 DIN(m) to N(m), DC to 7.5 GHz, 50 Ω
	510-93-R 7/16 DIN(m) to N(f), DC to 7.5 GHz, 50 Ω
	1091-467-R Adapter, DC to 6 GHz, 4.3-10(m) to N(f), 50 Ω
	510-97-R 7/16 DIN(f) to 7/16 DIN (f), DC to 7.5 GHz, 50 Ω
	1091-323-R DC to 18 GHz, TNC(f) to TNC(f), 50 Ω
	1091-326-R DC to 18 GHz, TNC(m) to TNC(m), 50 Ω
	34RKNF50 DC to 18 GHz, Ruggedized K(m) to N(f), 50 Ω

Attenuators N Type (up to 18 GHz)











Accessory	Description
	1010-121-R 40 dB, 100 W, DC to 18 GHz, N(f) to N(m), Uni-directional
	3-1010-122 20 dB, 5 W, DC to 12.4 GHz, N(m) to N(f)
	3-1010-123 30 dB, 50 W, DC to 8.5 GHz, N(m) to N(f)
	3-1010-124 40 dB, 100 W, DC to 8.5 GHz, N(f) to N(m), Uni-directional

Accessory	Description
	42N50-20 20 dB, 5 W, DC to 18 GHz, N(m) to N(f)
	42N50A-30 30 dB, 50 W, DC to 18 GHz, N(m) to N(f)
	1010-127-R 30 dB, 150 W, DC to 3 GHz, N(m) to N(f)
	1010-128-R 40 dB, 150 W, DC to 3 GHz, N(m) to N(f)



Attenuators K Type (up to 40 GHz)

Accessory	Description
	41KB-3 Precision, K(m) to K(f), 3 dB, DC to 26.5 GHz, 50 Ω
	41KB-6 Precision, K(m) to K(f), 6 dB, DC to 26.5 GHz, 50 Ω
	41KB-10 Precision, K(m) to K(f), 10 dB, DC to 26.5 GHz, 50 Ω
	41KB-20 Precision, K(m) to K(f), 20 dB, DC to 26.5 GHz, 50 Ω

Accessory	Description
	41KC-3 Precision, K(m) to K(f), 3 dB, DC to 40 GHz, 50 Ω
	41KC-6 Precision, K(m) to K(f), 6 dB, DC to 40 GHz, 50 Ω
	41KC-10 Precision, K(m) to K(f), 10 dB, DC to 40 GHz, 50 Ω
	41KC-20 Precision, K(m) to K(f), 20 dB, DC to 40 GHz, 50 Ω

Phase-Stable Test Port Cables (Armored and Flexible)		Accessory	Description
	14KFK50-0.6 1.0 m (39in), DC to 40 GHz, K(f) to K(m), 50 Ω		15NNF50-1.0B 1.0 m (39in), DC to 18 GHz, N(m) to N(f), 50 Ω
	14KFK50-0.6 1.0 m (39in), DC to 40 GHz, K(f) to K(m), 50 Ω		15LL50-1.0A 1.0 m (39in), DC to 20 GHz, 3.5 mm(m) to 3.5 mm(m), 50 Ω
	14KFKF50-1.0 1.0 m (39in), DC to 40 GHz, K(f) to K(f), 50 Ω		15LLF50-1.0A 1.0 m (39in), DC to 20 GHz, 3.5 mm(m) to 3.5 mm(f), 50 Ω
	14KFK50-1.0 1.0 m (39in), DC to 40 GHz, K(f) to K(m), 50 Ω		15KK50-1.0A 1.0 m (39in), DC to 26.5 GHz, K(m) to K(m), 50 Ω
	15NN50-1.0B 1.0 m (39in), DC to 18 GHz, N(m) to N(m), 50 Ω		15KKF50-1.0A 1.0 m (39in), DC to 26.5 GHz, K(m) to K(f), 50 Ω
Phase-Stable Test Port Cables, Armored		Accessory	Description
	15NNF50-1.5C 1.5 m, DC to 6 GHz, N(m) to N(f), 50 Ω		15NDF50-1.5C 1.5 m, DC to 6 GHz, N(m) to 7/16 DIN(f), 50 Ω
	15NN50-1.5C 1.5 m, DC to 6 GHz, N(m) to N(m), 50 Ω		15ND50-1.5C 1.5 m, DC to 6 GHz, N(m) to 7/16 DIN(m), 50 Ω
	15NNF50-3.0C 3.0 m, DC to 6 GHz, N(m) to N(f), 50 Ω		15N43M50-1.5C Test Port Extension Cable, Armored, 1.5 m, DC to 6 GHz, N(m) to 4.3-10(m)
	15NN50-3.0C 3.0 m, DC to 6 GHz, N(m) to N(m), 50 Ω		15N43F50-1.5C Test Port Extension Cable, Armored, 1.5 m, DC to 6 GHz, N(m) to 4.3-10(f)
	15NNF50-5.0C 5.0 m, DC to 6 GHz, N(m) to N(f), 50 Ω		15N43M50-3.0C Test Port Extension Cable, Armored, 3 m, DC to 6 GHz, N(m) to 4.3-10(m)
	15NN50-5.0C 5.0 m, DC to 6 GHz, N(m) to N(m), 50 Ω		15N43F50-3.0C Test Port Extension Cable, Armored, 3 m, DC to 6 GHz, N(m) to 4.3-10(f)
Phase-Stable 18 GHz and 40 GHz Semi-Rigid Cables (Armored)		Accessory	Description
	3670K50A-1 0.3 m (12 in), DC to 40 GHz, K(f) to K(m), 50 Ω		3670N50-1 0.3 m (12 in), DC to 18 GHz, N(f) to N(m), 50 Ω
	3670K50A-2 0.6 m (24 in), DC to 40 GHz, K(f) to K(m), 50 Ω		3670N50-2 0.6 m (24 in), DC to 18 GHz, N(f) to N(m), 50 Ω
	3670NN50-1 0.3 m (12 in), DC to 18 GHz, N(m) to N(m), 50 Ω		
	3670NN50-2 0.6 m (24 in), DC to 18 GHz, N(m) to N(m), 50 Ω		









GPS Antennas (active)

Accessory	Description
	2000-1528-R Magnet Mount, SMA(m) with 5 m (16.4 ft) cable, requires 5 VDC
	2000-1652-R Magnet Mount, SMA(m) with 0.3 m (1 ft) cable, requires 3.3 VDC or 5 VDC

Accessory **Description**

	2000-1760-R Miniature Antenna, SMA(m), requires 2.5 VDC to 3.7 VDC
-----------------------------------------------------------------------------------	-----------------------------------------------------------------------

Directional Antennas

Accessory	Description
	2000-1411-R 824 MHz to 896 MHz, N(f), 12.3 dBi, Yagi
	2000-1412-R 885 MHz to 975 MHz, N(f), 12.6 dBi, Yagi
	2000-1413-R 1710 MHz to 1880 MHz, N(f), 12.3 dBi, Yagi
	2000-1414-R 1850 MHz to 1990 MHz, N(f), 11.4 dBi, Yagi
	2000-1415-R 2400 MHz to 2500 MHz, N(f), 14.1 dBi, Yagi
	2000-1416-R 1920 MHz to 2170 MHz, N(f), 14.3 dBi, Yagi
	2000-1659-R 698 MHz to 787 MHz, N(f), 10.1 dBi, Yagi
	2000-1660-R 1425 MHz to 1535 MHz, N(f), 14.3 dBi, Yagi
	2000-2107-R Log Periodic, 20 MHz to 8.5 GHz

Accessory **Description**

	2000-1726-R 2500 MHz to 2700 MHz, N(f), 14.1 dBi, Yagi
	2000-1798-R Port Extender, DC to 6 GHz
	2000-1748-R Log Periodic, 1 GHz to 18 GHz, N(f), 6 dBi, typical
	2000-1777-R 9 kHz to 20 MHz, N(f) (requires port extender 2000-1798-R when used with MA2700A)
	2000-1778-R 20 MHz to 200 MHz, N(f) (requires port extender 2000-1798-R when used with MA2700A)
	2000-1779-R 200 MHz to 500 MHz, N(f) (requires port extender 2000-1798-R when used with MA2700A)
	2000-1812-R Portable Yagi Antenna, 450 MHz to 512 MHz, N(f), 7.1 dBi
	2000-1825-R Portable Yagi Antenna, 380 MHz to 430 MHz, N(f), 7.1 dBi

Portable Antennas (requires 1091-27-R SMA(f) to N(m) or 1091-172-R BNC(f) to N(m) adapter)

Accessory	Description
	2000-1200-R 806 MHz to 866 MHz, SMA(m), 50 Ω
	2000-1473-R 870 MHz to 960 MHz, SMA(m), 50 Ω
	2000-1035-R 896 MHz to 941 MHz, SMA(m), 50 Ω (1/2 wave)
	2000-1030-R 1710 MHz to 1880 MHz, SMA(m), 50 Ω (1/2 wave)
	2000-1474-R 1710 MHz to 1880 MHz with knuckle elbow (1/2 wave)
	2000-1031-R 1850 MHz to 1990 MHz, SMA(m), 50 Ω (1/2 wave)

Accessory	Description
	2000-1475-R 1920 MHz to 1980 MHz and 2110 MHz to 2170 MHz, SMA(m), 50 Ω
	2000-1032-R 2400 MHz to 2500 MHz, SMA(m), 50 Ω (1/2 wave)
	2000-1751-R 698 MHz to 960 MHz, 1710 MHz to 2100 MHz, 2500 MHz to 2700 MHz, SMA(m), 2 dB, typical, 50 Ω
	2000-1361-R 2400 MHz to 2500 MHz, 5000 MHz to 6000 MHz, SMA(m), 50 Ω
	2000-1636-R Antenna Kit (Consists of: 2000-1030-R, 2000-1031-R, 2000-1032-R, 2000-1200-R, 2000-1035-R, 2000-1361-R, and carrying pouch)
	2000-1487-R Telescoping Whip Antenna, BNC

Magnet Mount and Broadband Antennas

Accessory	Description
	2000-2141-R 20 MHz to 21000 MHz, N(f), 50 Ω
	2000-1647-R Cable 1: 698 MHz to 1200 MHz, 2 dBi peak gain, 1700 MHz to 2700 MHz, 5 dBi peak gain, N(m), 50 Ω, 10 ft Cable 2: 3000 MHz to 6000 MHz, 5 dBi peak gain, N(m), 50 Ω, 10 ft Cable 3: GPS 26 dB gain, SMA(m), 50 Ω, 10 ft
	2000-1645-R 694 MHz to 894 MHz, 3 dBi peak gain 1700 MHz to 2700 MHz, 3 dBi peak gain, N(m), 50 Ω, 10 ft

Accessory	Description
	2000-1646-R 750 MHz to 1250 MHz, 3 dBi peak gain, 1650 MHz to 2000 MHz, 5 dBi peak gain, 2100 MHz to 2700 MHz, 5 dBi peak gain, N(m), 50 Ω, 10 ft
	2000-1946-R Cable 1: 617 MHz to 960 MHz, 3 dBi peak gain, 1710 MHz to 3700 MHz, 4 dBi peak gain, N(m), 50 Ω, 10 ft Cable 2: 3000 MHz to 6000 MHz, 5 dBi peak gain, N(m), 50 Ω, 10 ft Cable 3: GPS 26 dB gain, SMA(m), 50 Ω, 10 ft
	2000-1648-R 1700 MHz to 6000 MHz, 3 dBi peak gain, N(m), 50 Ω, 10 ft



Bandpass Filters

Accessory	Description
	1030-114-R 806 MHz to 869 MHz, N(m) to SMA(f), 50 Ω
	1030-109-R 824 MHz to 849 MHz, N(m) to SMA(f), 50 Ω
	1030-110-R 880 MHz to 915 MHz, N(m) to SMA(f), 50 Ω
	1030-111-R 1850 MHz to 1910 MHz, N(m) to SMA(f), 50 Ω
	1030-112-R 2400 MHz to 2484 MHz, N(m) to SMA(f), 50 Ω
	1030-105-R 890 MHz to 915 MHz, N(m) to N(f), 50 Ω
	1030-106-R 1710 MHz to 1790 MHz, N(m) to N(f), 50 Ω
	1030-107-R 1910 MHz to 1990 MHz, N(m) to N(f), 50 Ω
	1030-149-R High Pass, 150 MHz, N(m) to N(f), 50 Ω
	1030-150-R High Pass, 400 MHz, N(m) to N(f), 50 Ω
	1030-151-R High Pass, 700 MHz, N(m) to N(f), 50 Ω
	1030-152-R Low Pass, 200 MHz, N(m) to N(f), 50 Ω
	1030-153-R Low Pass, 550 MHz, N(m) to N(f), 50 Ω
	1030-155-R 2500 MHz to 2700 MHz, N(m) to N(f), 50 Ω
	1030-178-R 1920 MHz to 1980 MHz, N(m) to N(f), 50 Ω
	1030-179-R 777 MHz to 798 MHz, N(m) to N(f), 50 Ω
	1030-180-R 2500 MHz to 2570 MHz, N(m) to N(f), 50 Ω

Accessory Description

Accessory	Description
	2000-1734-R 699 MHz to 715 MHz, N(m) and N(f), 50 Ω
	2000-1735-R 776 MHz to 788 MHz, N(m) and N(f), 50 Ω
	2000-1736-R 815 MHz to 850 MHz, N(m) and N(f), 50 Ω
	2000-1737-R 1711 MHz to 1756 MHz, N(m) and N(f), 50 Ω
	2000-1738-R 1850 MHz to 1910 MHz, N(m) and N(f), 50 Ω
	2000-1739-R 880 MHz to 915 MHz, N(m) and N(f), 50 Ω
	2000-1740-R 1710 MHz to 1785 MHz, N(m) and N(f), 50 Ω
	2000-1741-R 1920 MHz to 1980 MHz, N(m) and N(f), 50 Ω
	2000-1742-R 832 MHz to 862 MHz, N(m) and N(f), 50 Ω
	2000-1743-R 2500 MHz to 2570 MHz, N(m) and N(f), 50 Ω
	2000-1799-R 2305 MHz to 2320 MHz, N(m) and N(f), 50 Ω
	2000-1911-R 703 MHz to 748 MHz, N(m) and N(f), 50 Ω
	2000-1912-R 788 MHz to 798 MHz, N(m) and N(f), 50 Ω
	2000-1925-R 663 MHz to 698 MHz, N(m) and N(f), 50 Ω
	2000-1926-R 776 MHz to 806 MHz, N(m) and N(f), 50 Ω
	2000-1684-R 791 MHz to 821 MHz, N(m) to N(f), 50 Ω

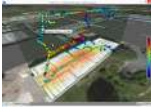
NEON® MA8100A Signal Mapper

Accessory	Description	Accessory	Description
	MA8100A-000 NEON Signal Mapper with Anritsu Integration and Tracking Unit. Includes 3 months NEON Software License with 3 months of maintenance and support and 3 months of Cloud Service (PN: 2300-607).		2300-606 Perpetual NEON Software License with 3 years of maintenance and support and 3 years of Cloud Service. Part number can also be used to order a perpetual license after a limited term license has expired.
	MA8100A-001 NEON Signal Mapper with Anritsu Integration and Tracking Unit. Includes 1 year NEON Software License with 1 year of maintenance and support and 1 year of Cloud Service (PN: 2300-574).		2300-612 Renewal of 1 year NEON Software License with 1 year of maintenance and support and 1 year of Cloud Service.
	MA8100A-003 NEON Signal Mapper with Anritsu Integration and Tracking Unit. Includes 3 year NEON Software License with 3 years of maintenance and support and 3 years of Cloud Service (PN: 2300-575).		2300-613 Renewal of 3 year NEON Software License with 3 years of maintenance and support and 3 years of Cloud Service.
	MA8100A-005 NEON Signal Mapper with Anritsu Integration and Tracking Unit. Includes 5 year NEON Software License with 5 years of maintenance and support and 5 years of Cloud Service (PN: 2300-576).		2300-614 Renewal of 5 year NEON Software License with 5 years of maintenance and support and 5 years of Cloud Service.
	MA8100A-100 NEON Signal Mapper with Anritsu Integration and Tracking Unit. Includes Perpetual NEON Software License with 3 years of maintenance and support and 3 years of Cloud Service (PN: 2300-606).		
	2000-1852-R NEON Tracking Unit (includes USB cable and belt clip, Worldwide version)		
	2000-2015-R NEON Tracking Unit (includes USB cable and belt clip, Japan version)		
	2000-1853-R Belt clip (for NEON Tracking Unit)		

Manuals

Part Number	Description
10100-00065	Product Information, Compliance, and Safety
10580-00349	Spectrum Analyzer Measurement Guide
10580-00240	Power Meter Measurement Guide
10580-00289	VNA Measurement Guide
10580-00301	VNA Master User Guide
10580-00302	VNA Master Programming Manual
10580-00303	VNA Master Maintenance Manual
11410-00424	USB Power Sensor MA24106A
11410-00472	Measuring Interference
11410-00504	Microwave USB Power Sensor MA241x8A
11410-00531	Practical Tips on Making "Vector Voltmeter (VVM)" Phase Measurements using VNA Master (Option 15)
11410-00545	VNA Master + Spectrum Analyzer Brochure
11410-00549	VNA Master + Spectrum Analyzer Technical Data Sheet