



# Analog Wireless (FM/ΦM/AM) Test Solution

- Analog Measurement Software MX269018A -

Signal Analyzer



MS2830A / MS2840A

Version 16.00

# Signal Analyzer MS2830A/MS2840A

The Analog Measurement Software **MX269018A** for the Signal Analyzer **MS2830A/MS2840A** measures the TRx performance of analog wireless equipment (FM/ $\Phi$ M/AM). Combining options such as the analog signal generator, audio analyzer, etc., according to the measurement items supports fast, high-accuracy measurements for development, production and maintenance of analog wireless equipment.

✓: Supported; Blank: Not supported

Main Option Function	Application	MS2830A		MS2840A	
		3.6 GHz/6 GHz Model	13.5 GHz Model	3.6 GHz/6 GHz Model	26.5 GHz/44.5 GHz Model
		 <ul style="list-style-type: none"> <li>◆ Multi-function middle-class spectrum analyzer/signal analyzer with excellent cost-performance</li> <li>◆ Options for improved phase noise performance for measuring close-in spurious and adjacent channel leakage power (ACP) of narrowband wireless equipment</li> <li>◆ Options for digital wireless measurements and both analog/digital measurements</li> </ul>		 <ul style="list-style-type: none"> <li>◆ Middle-class spectrum analyzer/signal analyzer with excellent close-in phase noise performance exceeding top-class instruments</li> <li>◆ Substitute for aging high-end spectrum analyzers</li> <li>◆ Options for digital wireless measurements and both analog/digital measurements</li> </ul>	
Analog Modulation Analysis (FM/ $\Phi$ M/AM)	Tx Tests	✓	✓	✓	✓
Analog Signal Generator (FM/ $\Phi$ M/AM)	Rx Tests	✓		✓	
Audio Analyzer	TRx Tests	✓	✓		

# Section 1

## MS2830A

- Set-up
- Recommended Configuration
- Function and necessary composition
- Function Comparison between Legacy Model
- I/O Connectors
- Example of Connection Between DUT and Audio Analyzer
- Interface Setting Example of Audio Analyzer
- Spectrum Analyzer Function  
Excellent SSB phase noise performance

## MS2840A

- Set-up
- Recommended Configuration
- Function and necessary composition
- I/O Connectors
- Spectrum Analyzer Function  
Excellent SSB phase noise performance

## MS2830A (3.6 GHz/6 GHz models)

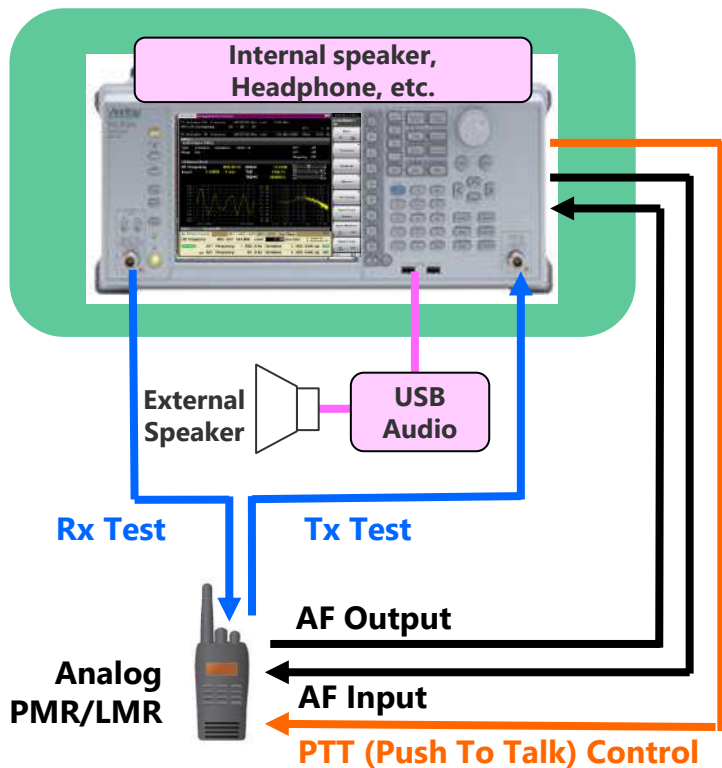

## MS2830A (13.5 GHz model)

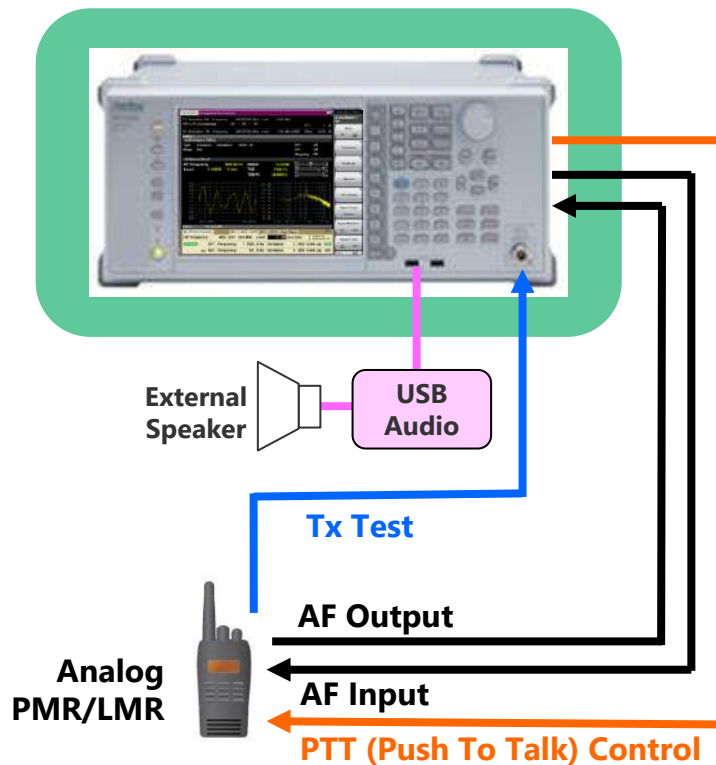

### MS2830A (3.6 GHz/6 GHz models)

Installing the Analog Signal Generator and Audio Analyzer options supports all-in-one measurement of main TRx characteristics (FM/ $\Phi$ M/AM) of analog wireless equipment.

### MS2830A (13.5 GHz model)

Installing the Audio Analyzer option supports all-in-one measurement of main Tx characteristics (FM/ $\Phi$ M/AM) of analog wireless equipment. The Analog Signal Generator option cannot be installed.

# Analog Wireless Measurement Recommended Configuration (MS2830A)

MS2830A

## At New Signal Analyzer MS2830A Purchase

\*The latter half of this document provides ordering information including retrofit options for the MS2830A and how to select the signal generator.

### Required Options

No.	Model	Name	Note
1	MS2830A-040	3.6 GHz Signal Analyzer	Select any one of the following. Frequency range: MS2830A-040: 9 kHz to 3.6 GHz MS2830A-041: 9 kHz to 6 GHz MS2830A-043: 9 kHz to 13.5 GHz
	MS2830A-041	6 GHz Signal Analyzer	
	MS2830A-043	13.5 GHz Signal Analyzer	
2	MS2830A-066	Low Phase Noise Performance	Improved phase noise performance: The MS2830A with MS2830A-066 option measures close-in spurious and adjacent channel leakage power (ACP) with excellent SSB phase noise performance.
3	MX269018A	Analog Measurement Software	Frequency setting range: At FM/ΦM/AM measurement: 100 kHz to the upper limit of the main unit At Wide Band FM measurement: 10 MHz to the upper limit of the main unit
4	A0086D	USB Audio	Outputs demodulated audio for Tx test

### Recommended Options <✓✓: Required, ✓: Recommended, Empty; Not required>

No.	Model	Name	Tx Test Only	Tx/Rx Test	Note
5	MS2830A-018	Audio Analyzer	✓✓	✓✓	AF Signal I/O function with built-in white-noise generation (ITU-T Recommendation G.227) and PTT Control functions
6	MS2830A-088	3.6 GHz Analog Signal Generator		✓✓	Frequency setting range (FM/ΦM/AM): 100 kHz to 3000 MHz Cannot be installed with MS2830A-043
7	MS2830A-002	High Stability Reference Oscillator	✓	✓	Aging rate: $\pm 1 \times 10^{-7}$ /year Start-up characteristics: $\pm 5 \times 10^{-8}$ (5 minutes after power-on)
8	MS2830A-052	Internal Signal Generator Control Function		✓	Equivalent functions to tracking generator for measuring transmission characteristics (frequency characteristics) of filters, amplifiers, etc.

# Function and necessary composition (MS2830A)

MS2830A

Analog measurement software function [MS2830A]*1			Modulation method of target signal			Requires Options
			FM	ΦM	AM	
Tx Tests	RF Measure	Carrier Frequency and Carrier Frequency Error <a href="#">RF Frequency</a>	✓	✓	✓	<b>1, 2, 3, 4 is mandatory</b> 1. Signal Analyzer (MS2830A-040/041/043*) 2. Low Phase Noise Performance (MS2830A-066) 3. Analog Measurement Software (MX269018A) 4. USB Audio (A0086D) 5. commercial speaker  *: MS2830A-043 cannot be installed MS2830A-066 and 7. Analog Signal Generator simultaneously.  1 + 2 + 3 + 4 + 6 Audio Analyzer (MS2830A-018)
		Transmit Power <a href="#">RF Power</a>	✓	✓	✓	
		Modulation measurement <a href="#">Deviation(FM), Radian(ΦM), Depth(AM)</a>	✓	✓	✓	
		Result of analyzed DCS Code <a href="#">DCS Code</a>	✓			
	AF Measure (Demodulation)	Demodulation Frequency <a href="#">AF Frequency</a>	✓	✓	✓	
		Effective Value for Level at Demodulation Frequency <a href="#">Level</a>	✓	✓	✓	
		Distortion Ratio of Demodulation Frequency Distortion <a href="#">Distortion, SINAD, THD</a>	✓	✓	✓	
		Time vs. Level, Frequency vs. Level <a href="#">Graph Result</a>	✓	✓	✓	
		Demodulate Input RF Signals from wireless equipment and Output Voice from USB connector *2	✓*3	✓	✓	
	AF Output (Audio Generator Function)	Demodulate Input RF Signals from wireless equipment and Output Sound from Internal speaker, Headphone jack and Demodulation Output Connector	✓*3			
AF tone, DCS, White Noise (ITU-T Recommendation G.227) , DTMF		✓	✓	✓		
PTT (Push To Talk) control			✓	✓	✓	
Rx Tests	RF Output	Modulation Signal Output (FM, ΦM, AM)	✓	✓	✓	1 + 2 + 3 + 4 + 7 Analog Signal Generator
		Internal Modulation Signal Source(AF tone)	✓	✓	✓	
		Internal Modulation Signal Source(DCS)	✓			
	AF Measure (Audio Analyzer Function)	Frequency <a href="#">AF Frequency</a>	✓	✓	✓	1 + 2 + 3 + 4 + 6 Audio Analyzer (MS2830A-018) + 7 Analog Signal Generator
		Effective Value for Level <a href="#">Level</a>	✓	✓	✓	
		Distortion Ratio <a href="#">SINAD, THD, THD+N</a>	✓	✓	✓	
		Graph(Time vs. Level, Frequency vs. Level) <a href="#">Graph Result</a>	✓	✓	✓	
	PTT (Push To Talk) control			✓	✓	✓

\*1: Spurious can also be measured using the standard spectrum analyzer measurement function.

\*2: Voice can be monitored by connecting a commercial loudspeaker using the A0086A, A0086B, A0086C or A0086D USB Audio.

\*3: The Wide Band FM measurement mode is not supported.

# Function Comparison between Legacy Model MS555 Series and MT2605 Series Radio Communication Analyzer



**MS555 Series**



**MT2605 Series**

\*1: Requires manual calculation

\*2: Requires optional USB Power Sensor

\*3: Low Phase Noise Function is not available.

		Items (Using FM Radio)	MS555 series	MT2605 series	MS2830A Audio Analyzer (MS2830A-018) Low Phase Noise Function (MS2830A-066) Analog Signal Generator (MS2830A-088) Analog Measurement Software (MX269018A)
Test Items	Tx Test	Tx Power	✓	✓	✓
		Tx Frequency	✓	✓	✓
		FM Deviation	✓	✓	✓
		Microphone input sensitivity	✓	✓	✓
		Modulation frequency characteristics	✓	✓	✓
		Distortion	✓	✓	✓
		S/N	✓	✓	✓
	Rx Test	Tone frequency	✓	✓	✓
		SINAD	✓	✓	✓
		Bandwidth	✓	✓	✓ *1
		AF Level	✓	✓	✓
		Demodulation frequency characteristics	✓	✓	✓
		Distortion	✓	✓	✓
		S/N	✓	✓	✓
Function	Squelch sensitivity	✓	✓	✓	
	Spectrum Analyzer		✓ *3	✓	
	Frequency Counter	✓	✓	✓	
	Power Meter	✓	✓	✓ *2	
	FM Linear Detector	✓	✓	✓	
	AF Level Meter	✓	✓	✓	
	AF Oscillator	✓	✓	✓	
	RF Signal Generator	✓	✓	✓	
	Monitor demodulated audio signal	✓	✓	✓	
	AF Oscillator for tone squelch	✓	✓	✓	
White noise (ITU-T Recommendation G.227)		✓	✓		

# MS2830A I/O Connectors (Analog Signal Generator/Audio Analyzer)

MS2830A

(with optional Analog Signal Generator and Audio Analyzer installed)

<Front Panel>

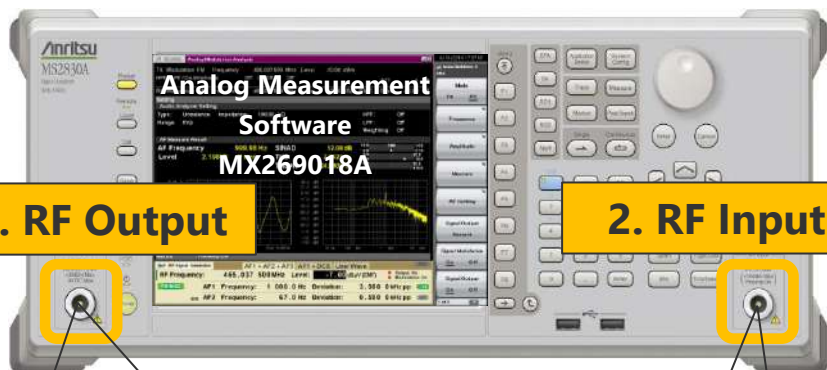

1. RF Output

2. RF Input

MS2830A-088 (or 188) / 029  
Analog Signal Generator (Option)

MS2830A  
Standard  
Built-in

<Back Panel>

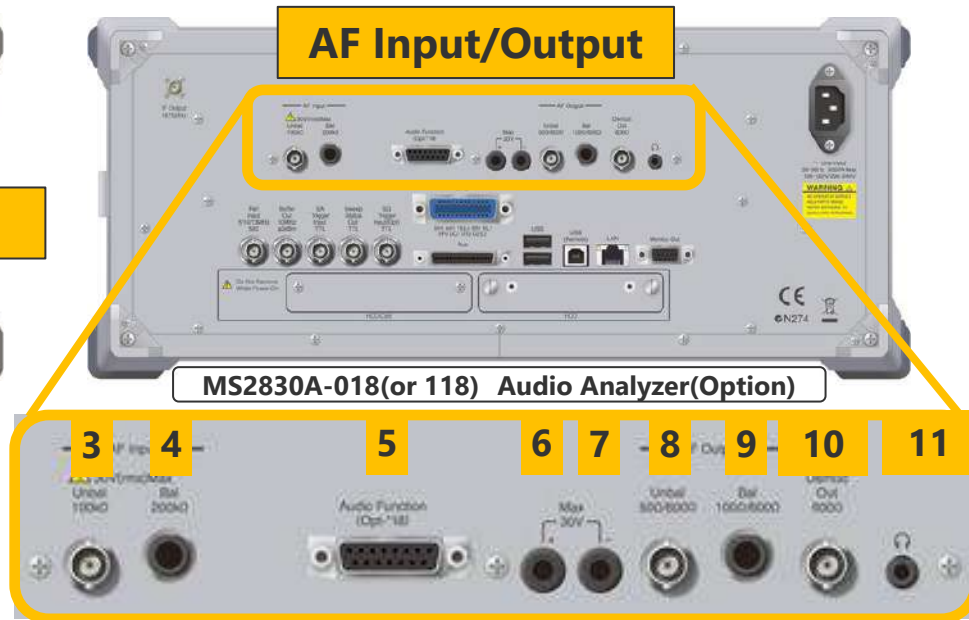

AF Input/Output

MS2830A-018(or 118) Audio Analyzer (Option)

3 4 5 6 7 8 9 10 11

	No.	Name	Connector	Note
Front	1	SG Output	N-J	100 kHz to 3000 MHz (FM/ΦM/AM)
	2	RF Input	N-J	9 kHz to 3.6 GHz, 6 GHz or 13.5 GHz* Frequency setting range (At FM/ΦM/AM measurement): 100 kHz to the upper limit of the main unit
Back	3	AF Input	Unbal 100 kΩ BNC-J	Unbalanced, 100 kΩ (AC coupling, nominal)
	4	AF Input	Bal 200 kΩ 1/4 inch phone jack (3 poles, Φ6.3 mm)	Balanced, 200 kΩ (AC coupling, nominal)
	5	Audio Function	D-sub15pin (jack)	Open collector x1 (5V, 100 mA max.), TTL Output x2, TTL Input x2
	6	PTT (-)	Banana jack (Φ4.0 mm)	PTT control (-) (+), 30V max., 500 mA max.
	7	PTT (+)	Banana jack (Φ4.0 mm)	
	8	AF Output	Unbal 50 Ω/600 Ω BNC-J	Unbalanced, 50/600 Ω (AC coupling, nominal)
	9	AF Output	Bal 100 Ω/600 Ω 1/4 inch phone jack (3-pole, Φ6.3 mm)	Balanced, 100/600 Ω (AC coupling, nominal)
	10	Demod Out 600 Ω	BNC-J	Demodulation Output (FM only) -10 dBm ±0.2 dB (Frequency Deviation = 3.5 kHz, 600 Ω)
	11		3.5 mm phone jack (2-pole)	Demodulation Output (FM only, for headphones, monaural)

\*: 13.5 GHz model (MS2830A-043) does not have built-in signal generator.

■ **AF Input connector (Balanced)**  
**AF Output connector (Balanced)**

1/4 inch phone jack (3 poles,  $\Phi 6.3$  mm)

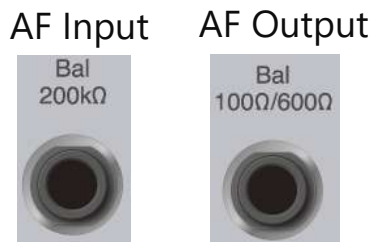

< 1/4 Inch Phone Plug >

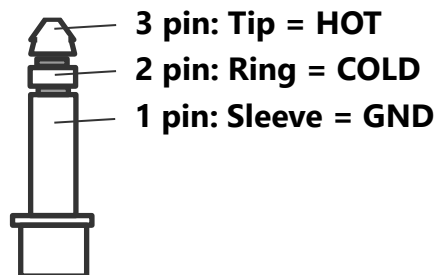

■ **General Input/Output (Audio Function) connector**

**D-Sub 15**

< connector pin assignment >

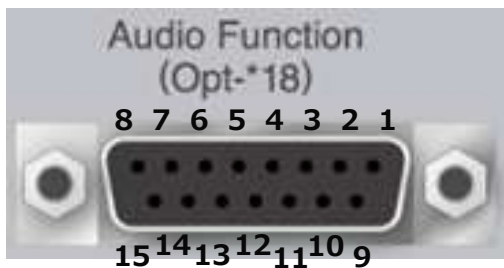

Pin Number	Signal Name
1	GND
2	GND
3	GND
4	RSV (Reserved)
5	RSV (Reserved)
6	GND
7	GND
8	GND

Pin Number	Signal Name
9	Open collector
10	TTL Output 1
11	TTL Output 2
12	Non Connection
13	TTL Input 1
14	TTL Input 2
15	Non Connection

This figure shows an example of connection between the DUT and the Audio Analyzer MS2830A-018/118. Either “unbalanced connector” or “balanced connector” can be used for AF input-output connector according to the DUT.

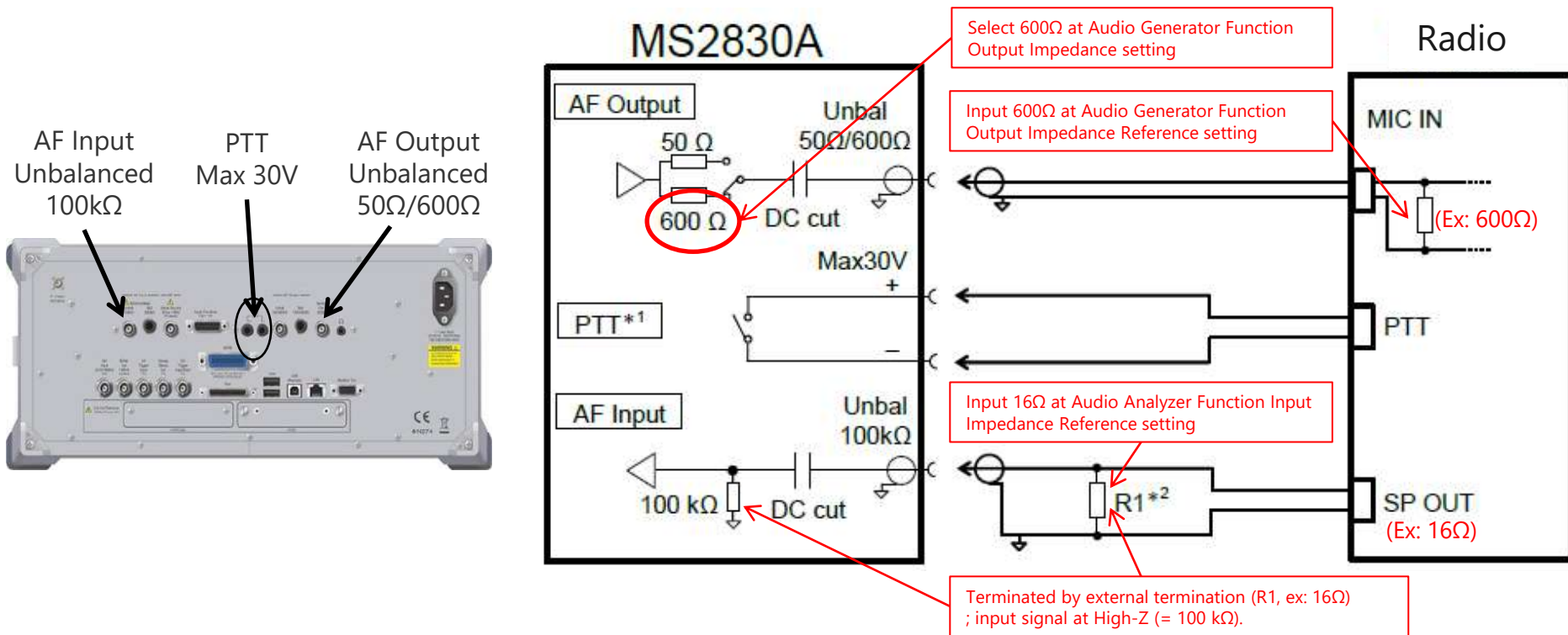

\*1: PTT terminal shows polarity for identifying terminals. It doesn't have polarity for a circuit.

PTT terminal has a built-in overcurrent protection circuit. If the protection circuit operates, turn Off the MS2830A and turn it On again.

\*2: R1: Termination corresponding to audio output impedance of the DUT.

This figure shows an example of connection between the DUT and the MS2830A-018/118 Audio Analyzer.

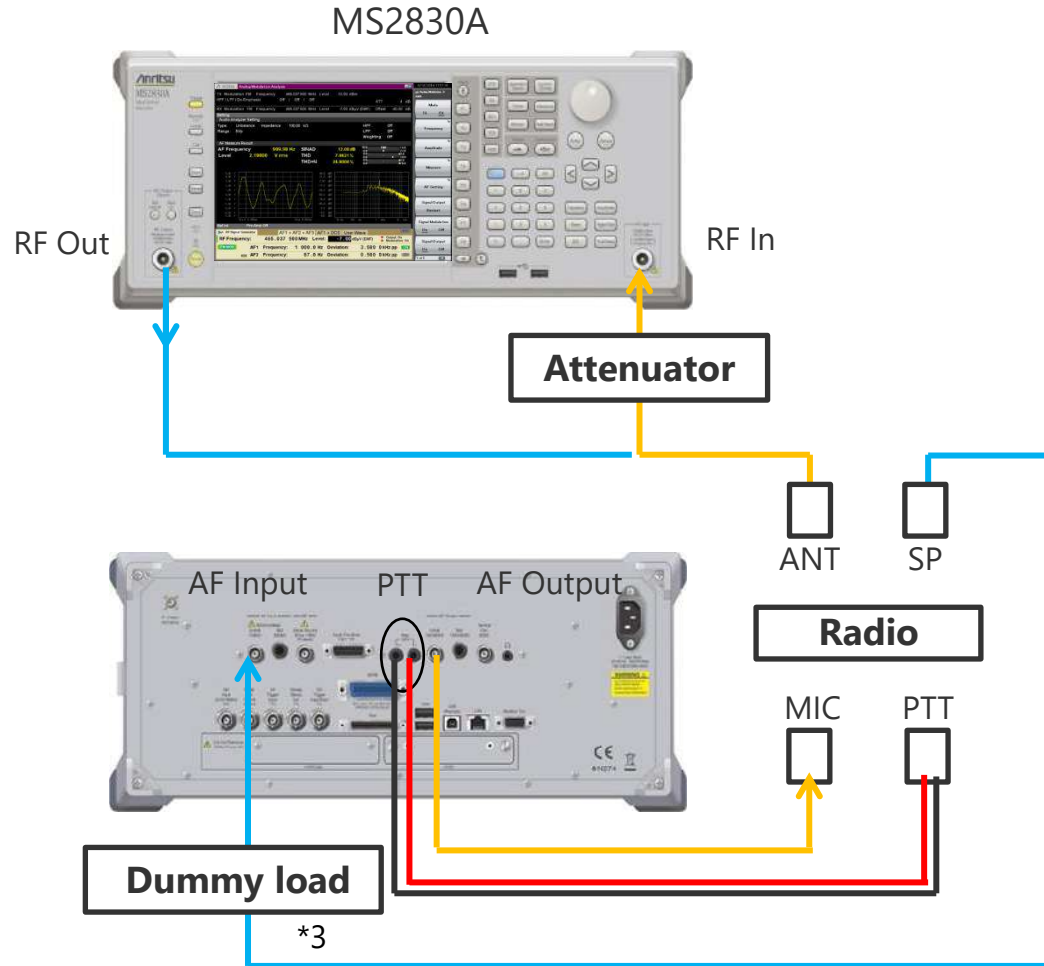

\*3: SP output dummy load.  
When the SP output is monaural (Unbal), insert a terminating resistance between the core and GND. When the SP output is stereo (Bal), insert a terminating resistance between Hot and Cold.

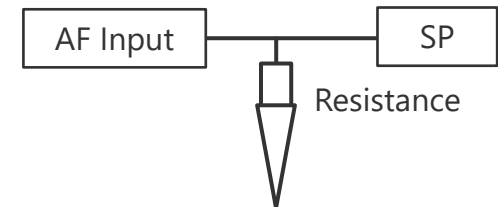

## Tx Test

This shows a setting example for the Audio Generator Function interface. Set Output Type/Output Impedance at the Tx test.

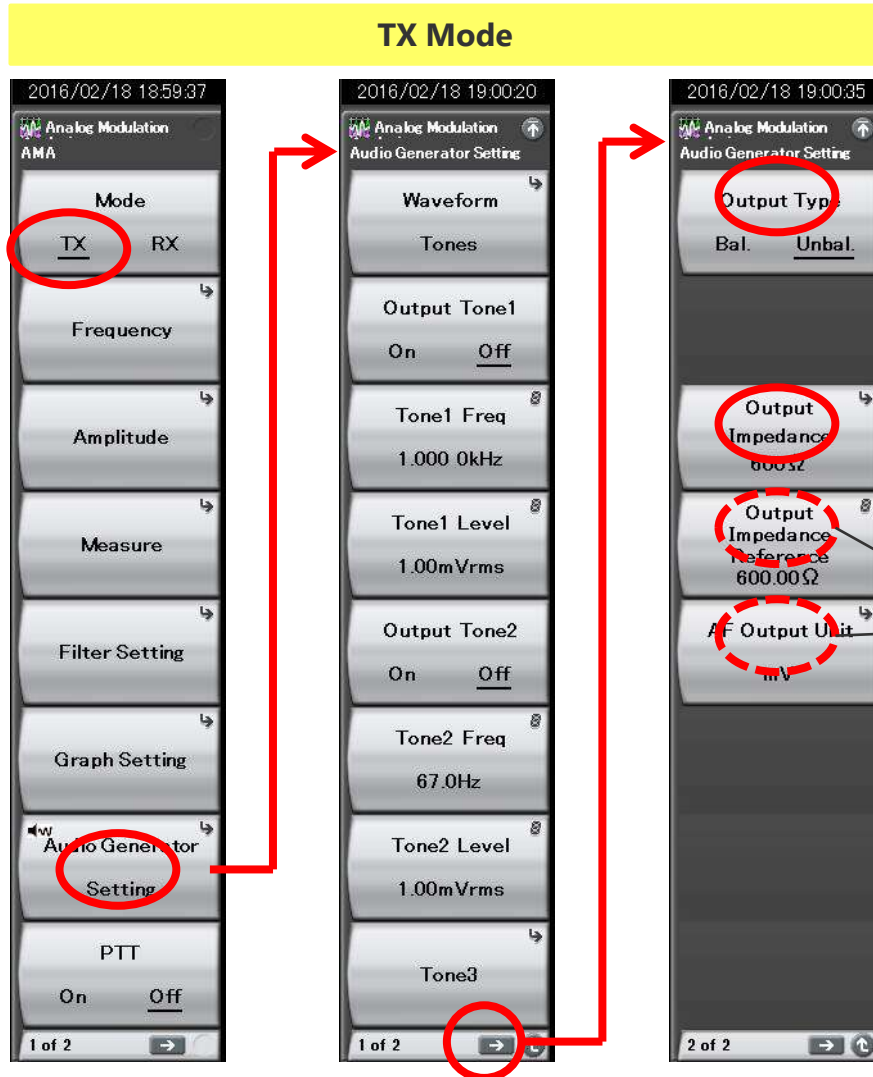

### ◆ Audio Generator Function Settings

Output Type	Balanced, Unbalanced
Output Impedance	Balanced: 100Ω, 600Ω Unbalanced: 50Ω, 600Ω
Output Impedance Reference	Sets the impedance reference used for converting power to dBm

When displaying the AF Output output level in power units (conversion), set the AF Output Unit to dBm (or W) and set the input impedance of the DUT side at Output Impedance Reference. Although the AF Output output level can be displayed in voltage units, in this case it is not necessary to set the Output Impedance Reference (Open Circuit Voltage). The relationship between the power and voltage settings is described in the latter half of this reference (Audio Output Settings) and in the operation manual.

## ◆ Relationship between Output Level Units and Output Level Display

From MS2830A firmware Package Version 7.03.00 \* (all units shipped from March 26, 2015), the relationship between the output units setting and output level display is as follows.

When output units set to <b>dBm</b>	<p>"Termination Power" is displayed.                  The power consumed by the termination resistance (0 dBm = 1 mW) is displayed.                  *Up to Package Version 7.02.00, the actual output level was 6 dB lower than the display.</p>
When output units set to <b>mV</b> or <b>V</b>	<p>"Open Circuit Voltage" is displayed.</p>

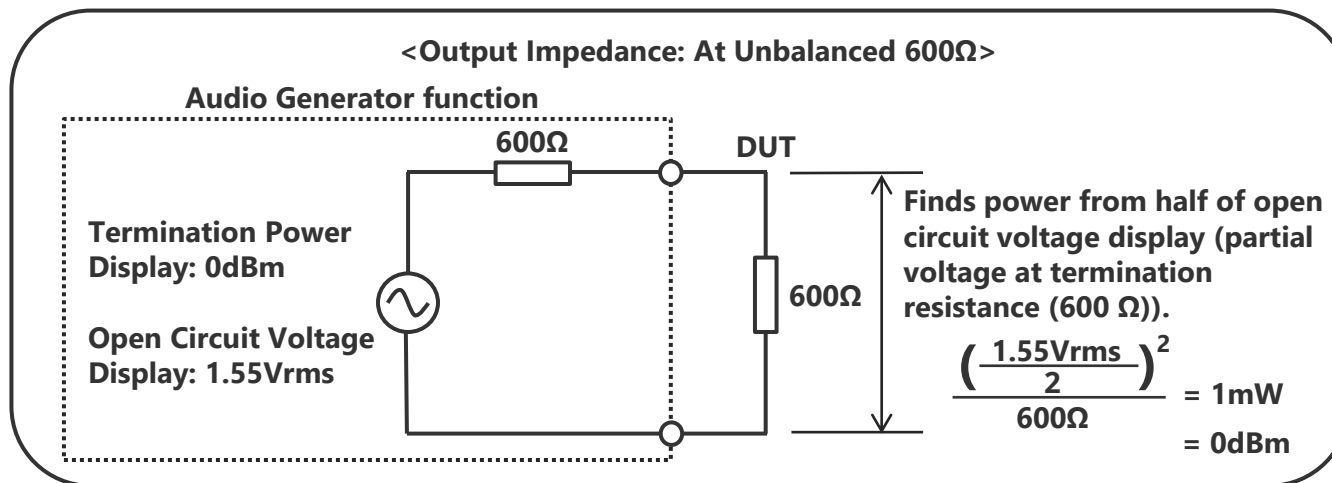

\*: <Firmware Confirmation Method>

Confirm the MS2830A firmware using the following operation.

Press [System Config] → [F5] System Information → [F2] Software Version View, and check the Package Version displayed at the top right of the screen.

## ◆ Supplementary Explanation: Output level of Audio Generator function

The output level of the Audio Generator can be set to either voltage or power (dBm). The voltage value and power value are converted to each other using the following formula.

When the output level is set as power (dBm) using this Audio Generator function, input the impedance of the DUT connected to the Audio Generator as the reference impedance (Output Impedance Reference (Rr)).

### Actual Output Level

MS2830A Setting Customer Usage Status	Output Impedance (Rs)	
	100Ω	600Ω
100Ω Termination	Power (dBm) <sup>*2</sup> Open Circuit Voltage/2 (V rms) <sup>*1</sup>	Power (dBm) <sup>*2</sup> Open Circuit Voltage × 1/7 (V rms) <sup>*1</sup>
600Ω Termination	Power (dBm) <sup>*3</sup> Open Circuit Voltage × 6/7 (V rms) <sup>*1</sup>	Power (dBm) <sup>*3</sup> Open Circuit Voltage/2 (V rms) <sup>*1</sup>
High Impedance (≥100 kΩ)	Open Circuit Voltage (V rms) <sup>*1</sup>	Open Circuit Voltage (V rms) <sup>*1</sup>

\*1: The voltage setting value and display setting value are shown as Open Circuit Voltage irrespective of the Output Impedance (Rs) and Output Impedance Reference (Rr) values.

\*2: When Output Impedance Reference (Rr) set to 100Ω

\*3: When Output Impedance Reference (Rr) set to 600Ω

### Formula

$$\text{dBm} = 10 \times \log_{10} \left( 1000 \times Rr \times \left( \frac{V_{rms}}{Rs + Rr} \right)^2 \right)$$

## Rx Test

This shows a setting example for the Audio Analyzer Function interface  
Set the Af Level Unit/Input Type/Input Impedance Reference at the Rx test.

### RX Mode

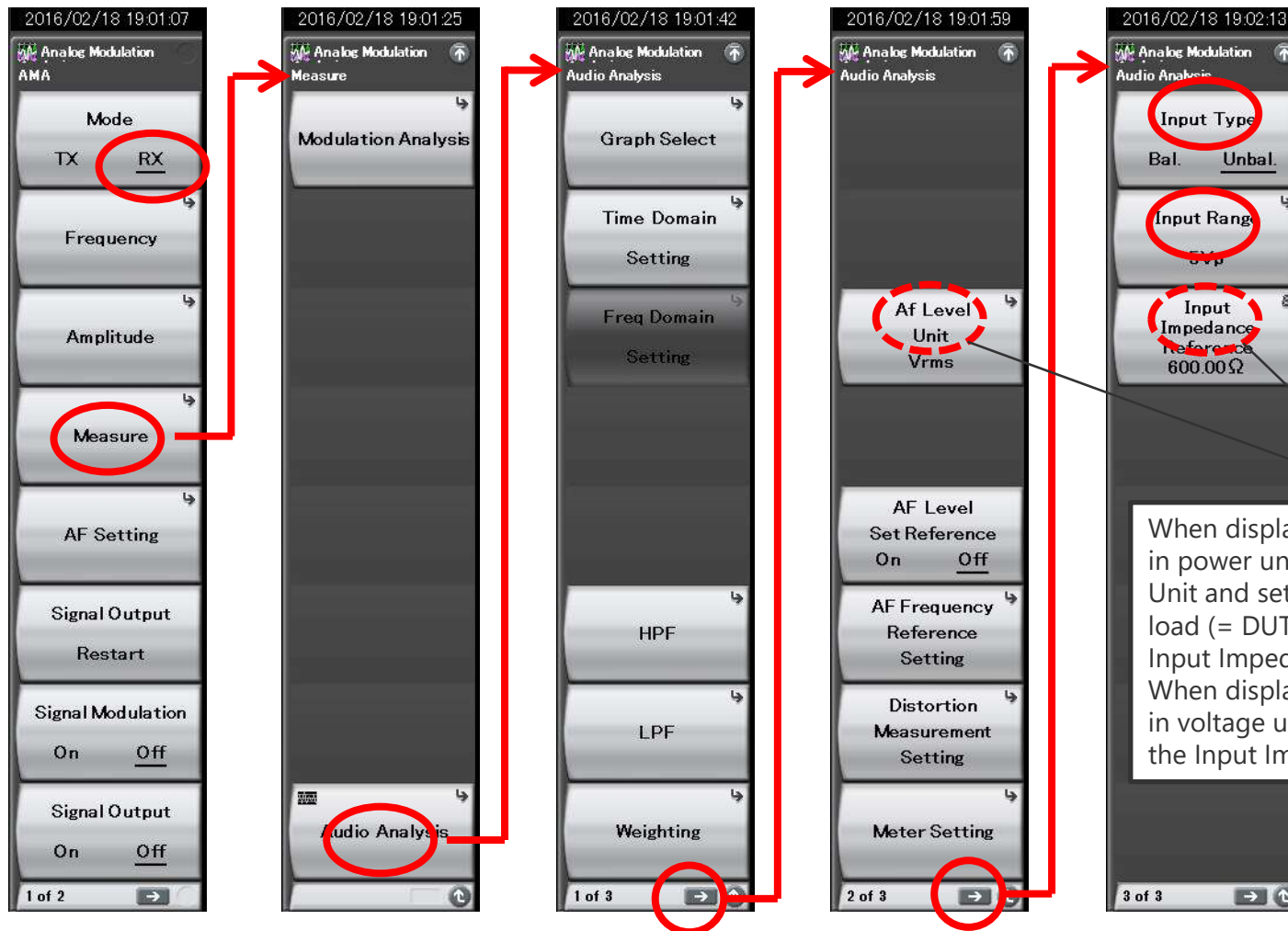

When displaying the measurement results in power units, set dBm (or W) at Af Level Unit and set the same value as the dummy load (= DUT side output impedance) at Input Impedance Reference.  
When displaying the measurement results in voltage units, it is not necessary to set the Input Impedance Reference.

## MS2840A (3.6 GHz/6 GHz models)

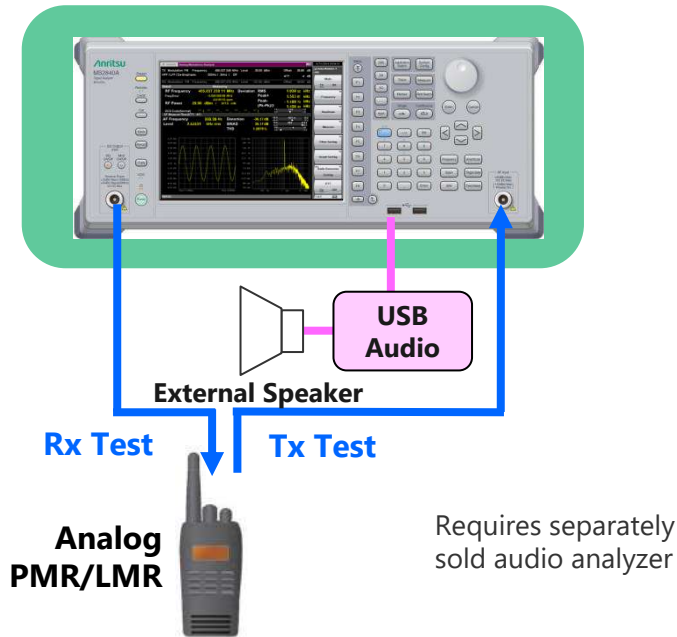

## MS2840A (26.5 GHz/44.5 GHz models)

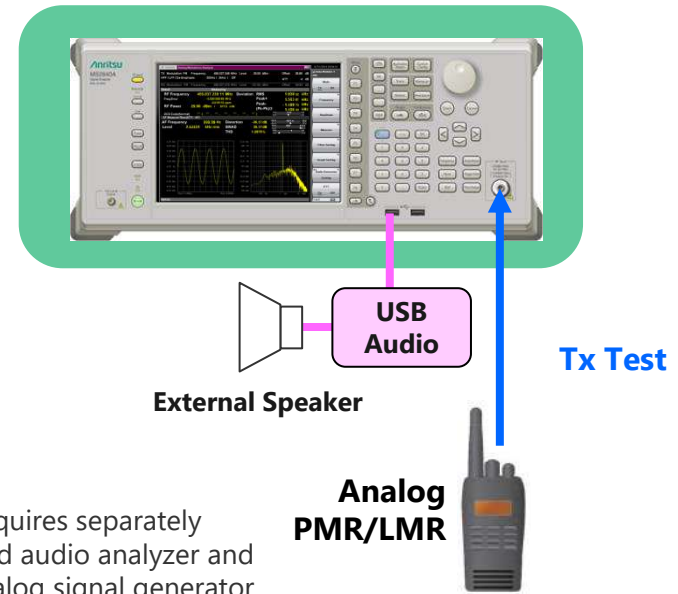

### MS2840A (3.6 GHz/6 GHz models)

Installing the Analog Signal Generator option supports all-in-one measurement of TRx characteristics (FM/ΦM/AM) of analog wireless equipment. The Audio Analyzer option cannot be installed.

### MS2840A (26.5 GHz/44.5 GHz models)

These models can measure the Tx characteristics (FM/ΦM/AM) of analog wireless equipment. The Analog Signal Generator and Audio Analyzer options cannot be installed.

# Analog Wireless Measurement Recommended Configuration (MS2840A)

MS2840A

## At New Signal Analyzer **MS2840A** Purchase

\*The latter half of this document provides ordering information including retrofit options for the MS2840A and how to select the signal generator.

## With 3.6 GHz Signal Analyzer (MS2840A-040) or 6 GHz Signal Analyzer (MS2840A-041)

### ■ Required Options

No.	Model	Name	Note
1	MS2840A-040	3.6 GHz Signal Analyzer	Select any one of the following. Frequency range: MS2830A-040: 9 kHz to 3.6 GHz MS2830A-041: 9 kHz to 6 GHz
	MS2840A-041	6 GHz Signal Analyzer	
2	MX269018A	Analog Measurement Software	Frequency setting range: At FM/ΦM/AM measurement: 100 kHz to the upper limit of the main unit At Wide Band FM measurement: 10 MHz to the upper limit of the main unit
3	A0086D	USB Audio	Outputs demodulated audio for Tx test

- Low Phase Noise Performance MS2840A-066 not required

### ■ Recommended Options <✓✓: Required, ✓: Recommended, Empty; Not required>

No.	Model	Name	Tx Test Only	Tx/Rx Test	Note
4	MS2840A-088	3.6 GHz Analog Signal Generator		✓✓	Frequency setting range (FM/ΦM/AM): 100 kHz to 3 GHz Cannot be installed with MS2830A-043
5	MS2840A-066	Low Phase Noise Performance	✓	✓	Improves phase noise performance. This option greatly improves SSB phase noise performance.
6	MS2840A-002	High Stability Reference Oscillator	✓	✓	Aging rate: $\pm 1 \times 10^{-7}$ /year Start-up characteristics: $\pm 5 \times 10^{-8}$ (5 minutes after power-on)

- No built-in audio analyzer options

# Analog Wireless Measurement Recommended Configuration (MS2840A)

MS2840A

## At New Signal Analyzer **MS2840A** Purchase

\*The latter half of this document provides ordering information including retrofit options for the MS2840A and how to select the signal generator.

### With 26.5 GHz Signal Analyzer (MS2840A-044) or 44.5 GHz Signal Analyzer (MS2840A-046)

#### ■ Required Options

No.	Model	Name	Note
1	MS2840A-044	26.5 GHz Signal Analyzer	Select any one of the following. Frequency range: MS2830A-040: 9 kHz to 26.5 GHz MS2830A-041: 9 kHz to 44.5 GHz
	MS2840A-046	44.5 GHz Signal Analyzer	
2	MX269018A	Analog Measurement Software	Frequency setting range: At FM/ΦM/AM measurement: 100 kHz to to the upper limit of the main unit At Wide Band FM measurement: 10 MHz to to the upper limit of the main unit
3	A0086D	USB Audio	Outputs demodulated audio for Tx test

- Supports Tx tests only
- No built-in analog signal generator, audio analyzer or low phase noise performance options
- MS2830A-044/046 supports same functions as High Stability Reference Oscillator option (MS2840A-002).

# Function and necessary composition (MS2840A)

MS2840A

Analog measurement software function [MS2840A]*1			Modulation method of target signal			Requires Options
			FM	ΦM	AM	
Tx Tests	RF Measure	Carrier Frequency and Carrier Frequency Error <a href="#">RF Frequency</a>	✓	✓	✓	<p>1, 2, 3 is mandatory</p> <p>1. Signal Analyzer (MS2840A-040/041/044/046)</p> <p>2. Analog Measurement Software (MX269018A)</p> <p>3. USB Audio (A0086D)</p> <p>4. commercial speaker</p>
		Transmit Power <a href="#">RF Power</a>	✓	✓	✓	
		Modulation measurement <a href="#">Deviation(FM), Radian(ΦM), Depth(AM)</a>	✓	✓	✓	
		Result of analyzed DCS Code <a href="#">DCS Code</a>	✓			
	AF Measure (Demodulation)	Demodulation Frequency <a href="#">AF Frequency</a>	✓	✓	✓	
		Effective Value for Level at Demodulation Frequency <a href="#">Level</a>	✓	✓	✓	
		Distortion Ratio of Demodulation Frequency Distortion <a href="#">Distortion, SINAD, THD</a>	✓	✓	✓	
		Time vs. Level, Frequency vs. Level <a href="#">Graph Result</a>	✓	✓	✓	
		Demodulate Input RF Signals from wireless equipment and Output Voice from USB connector *2	✓*3	✓	✓	
	Demodulate Input RF Signals from wireless equipment and Output Sound from Internal speaker, Headphone jack and Demodulation Output Connector				Not supported by MS2840A	
AF Output (Audio Generator Function)	AF tone, DCS, White Noise (ITU-T Recommendation G.227) , DTMF					
PTT (Push To Talk) control		✓	✓	✓		
Rx Tests	RF Output	Modulation Signal Output (FM, ΦM, AM)	✓	✓	✓	Not supported by MS2840A-044/046 1 + 2 + 3 + 5. Analog Signal Generator
		Internal Modulation Signal Source(AF tone)	✓	✓	✓	
		Internal Modulation Signal Source(DCS)	✓			
	AF Measure (Audio Analyzer Function)	Frequency <a href="#">AF Frequency</a>				Not supported by MS2840A
		Effective Value for Level <a href="#">Level</a>				
		Distortion Ratio <a href="#">SINAD, THD, THD+N</a>				
		Graph(Time vs. Level, Frequency vs. Level) <a href="#">Graph Result</a>				
	PTT (Push To Talk) control					

\*1: Spurious can also be measured using the standard spectrum analyzer measurement function.

\*2: Voice can be monitored by connecting a commercial loudspeaker using the A0086A, A0086B, A0086C or A0086D USB Audio.

\*3: The Wide Band FM measurement mode is not supported.

## MS2840A-040/041 (3.6GHz/6GHz models) with optional Analog Signal Generator installed



No.	Name	Connector	Note
1	SG Output	N-J	100 kHz to 3000 MHz (FM/ΦM/AM)
2	RF Input	N-J	9 kHz to 26.5 or 44.5 GHz Frequency setting range (At FM/ΦM/AM measurement): 100 kHz to the upper limit of the main unit

## MS2840A-044/046 (26.5GHz/44.5GHz models)



No.	Name	Connector	Note
1	RF Input	N-J (26.5GHz model) K-J (44.5GHz model)	9 kHz to 26.5 or 44.5 GHz Frequency setting range (At FM/ΦM/AM measurement): 100 kHz to the upper limit of the main unit

## Excellent SSB phase noise performance

The MS2830A with installed Low Phase Noise Performance MS2830A-066 option and the MS2840A with standard functions both have excellent SSB phase noise performance for measuring close-in spurious and adjacent channel leakage power (ACP), etc., of narrowband wireless equipment with extremely severe measurement standards.

### MS2830A Measurement Example

#### SSB Phase Noise

Center Frequency: 500 MHz

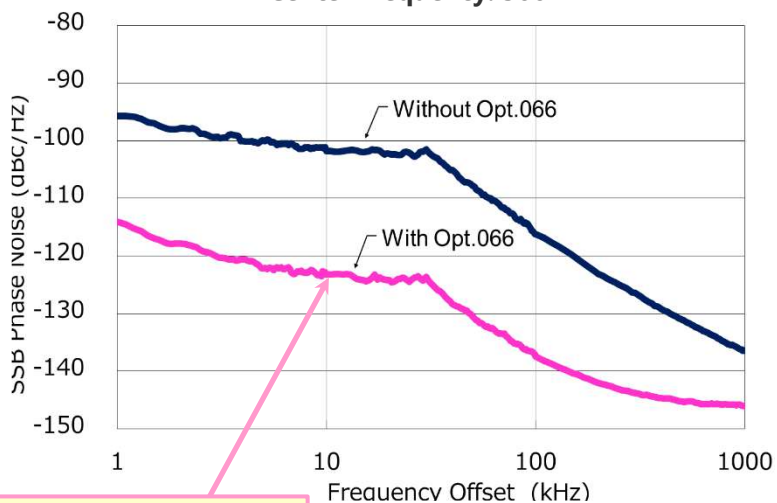

-123 dBc/Hz@10 kHz offset\*  
(Center frequency: 500 MHz)

The MS2840A with installed Low Phase Noise Performance MS2840A-066 option has excellent SSB phase noise performance. In addition to true evaluation of close-in spurious of wireless equipment, it also supports phase noise evaluation of signal sources in wireless equipment.

### MS2840A Measurement Example

#### SSB Phase Noise

Center Frequency: 500 MHz

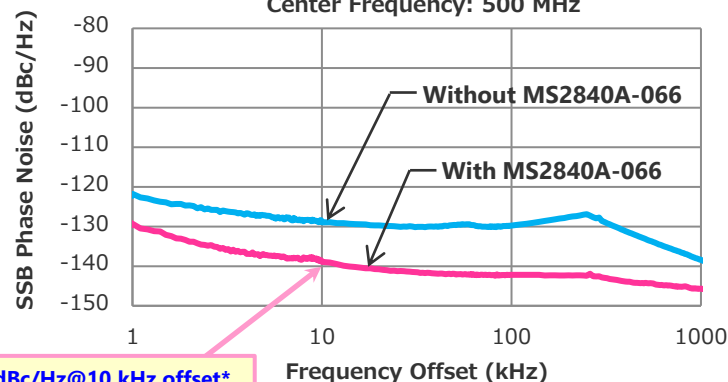

-138 dBc/Hz@10 kHz offset\*  
(Center frequency: 500 MHz)

#### SSB Phase Noise

Center Frequency: 150 MHz

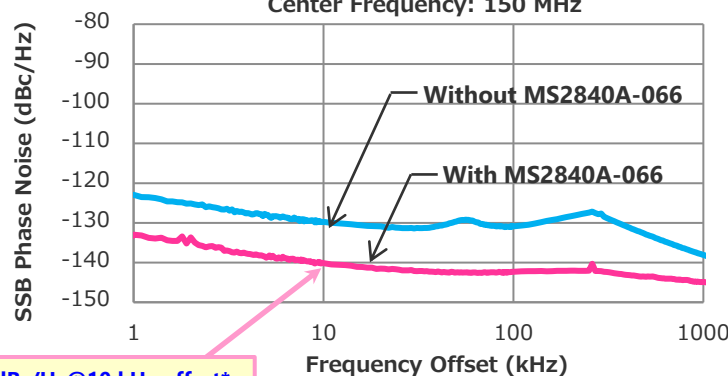

-140 dBc/Hz@10 kHz offset\*  
(Center frequency: 150 MHz)

\*: Value measured at design but not guaranteed specification

# Section 2

## Tx Test

## Demodulated Audio Output

- Measurement System Images
- Measurement Items, Filter Settings
- Audio Output Settings
- Tx Mode Screen
- Useful Meter Displays
- Audio Signal Graph Displays
- Demodulated Audio Output

## Rx Test

- Measurement System Images
- Measurement Items, Filter Settings
- Analog Signal Generator Settings
- Rx Mode Screen
- Internal Modulation Signal Source
- Useful Meter Displays
- Audio Signal Graph Displays

# MX269018A Measurement System Images <Tx Test>

## Tx Test

Input AF from Audio Generator to wireless equipment and measure Tx characteristics of RF signals output from wireless equipment.

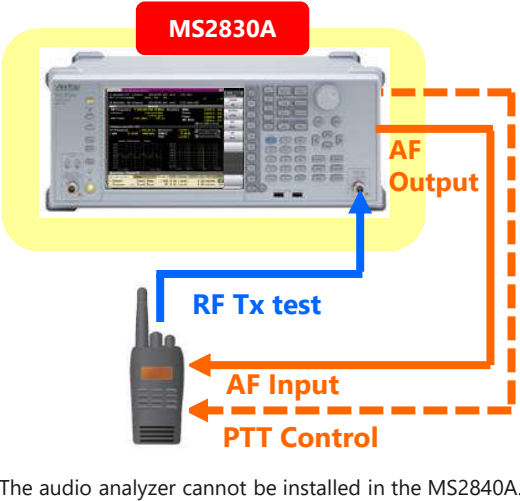
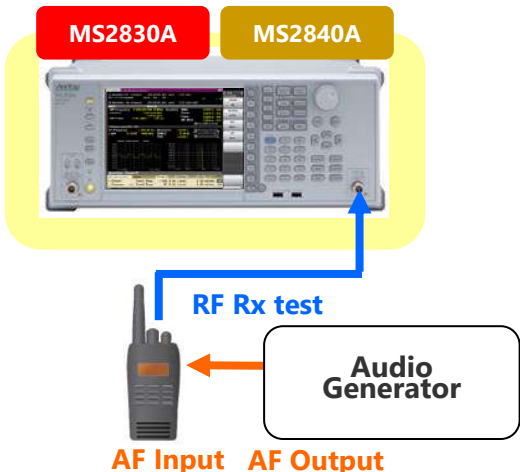
Built-in Option	Setup	Features and Functions
<p>Analog Measurement Software + Audio Analyzer</p>	 <p>The audio analyzer cannot be installed in the MS2840A.</p>	<ul style="list-style-type: none"> <li>➤ Supports Tx tests of FM/ΦM/AM analog radio equipment using all-in-one MS2830A with audio generator function</li> <li>➤ Displays AF signal output settings, RF Tx measurement results and demodulation results (tables/graphs) on one screen</li> <li>➤ In addition to AF tones (3 waveforms max.) also outputs White noise (ITU-T Recommendation G.227) and DTMF</li> <li>➤ Convenient meter displays for adjusting frequency deviation at FM Tx</li> <li>➤ Supports FM deviation measurements up to 1 MHz</li> <li>➤ Supports various settings including HPF, LPF, Weighting Filter and De-emphasis at demodulation measurement</li> <li>➤ DCS Code analysis displays (FM only)</li> <li>➤ PTT (Push To Talk) control</li> </ul>
<p>Analog Measurement Software only</p>		<ul style="list-style-type: none"> <li>➤ Supports Tx tests of FM/ΦM/AM analog radio equipment</li> <li>➤ RF Tx measurement results and demodulation results (table/graphs) confirmed on one screen</li> <li>➤ Convenient meter displays for adjusting frequency deviation at FM Tx</li> <li>➤ Supports FM deviation measurements up to 1 MHz</li> <li>➤ Supports various settings including HPF, LPF, Weighting Filter and De-emphasis at demodulation measurement</li> <li>➤ DCS Code analysis displays (FM only)</li> </ul>

# MX269018A Measurement System Images <Rx Test>

## Rx Test

Output RF signals for confirming operation and Rx Sensitivity tests from analog signal generator to radio equipment. Measure AF output from radio equipment with external Audio Analyzer for Rx Sensitivity tests.

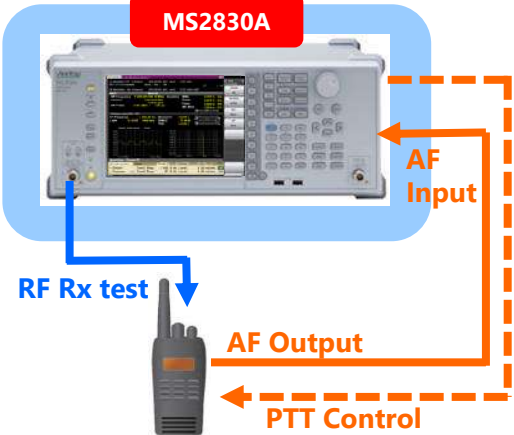
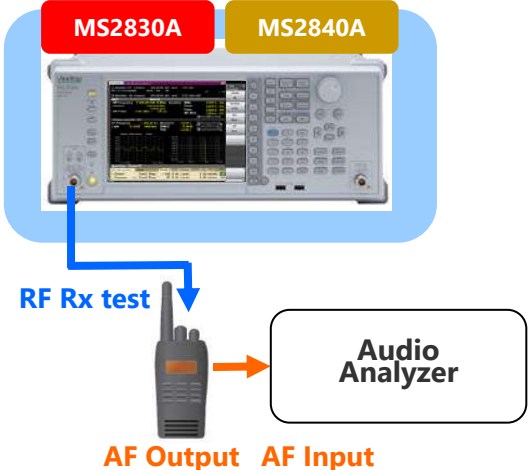
Built-in Option	Setup	Features and Functions
<p>Analog Measurement Software + Analog Signal Generator + Audio Analyzer</p>	 <p>The audio analyzer cannot be installed in the MS2840A.</p>	<ul style="list-style-type: none"> <li>➤ Supports Rx tests (SINAD measurements etc.) of FM/ΦM/AM analog radio equipment using all-in-one MS2830A with audio generator function</li> <li>➤ Displays RF signal generator settings and AF analysis results (tables/graphs) on one screen</li> <li>➤ Supports internal modulation output using AF tone (3 waveforms max.), DCS and Wave audio files</li> <li>➤ Various HPF, LPF, Weighting Filter settings for AF measurements</li> <li>➤ Convenient meter displays for SINAD measurements, etc.</li> </ul>
<p>Analog Measurement Software + Analog Signal Generator</p>		<ul style="list-style-type: none"> <li>➤ Output RF signals for FM/ΦM/AM analog radio equipment</li> <li>➤ Supports internal modulation output using AF tone (2 waveforms max.), DCS and Wave audio files</li> </ul>

# MX269018A Measurement System Images <Demodulation Voice Output>

Demodulated Audio Output

Monitor demodulated audio signals using USB audio, or internal speaker/headphone jack/demodulation output connector. USB audio requires separately sold speaker or headphone.

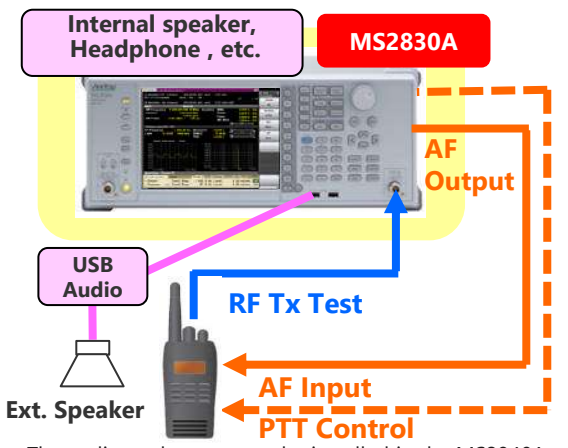
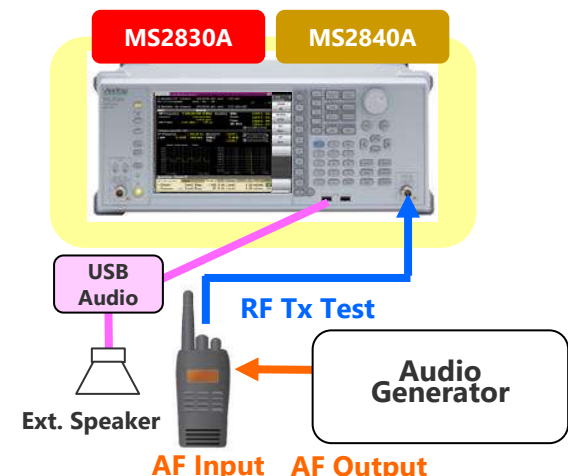
Built-in Option	Setup	Features and Functions
<p>Analog Measurement Software + Audio Analyzer</p>	 <p>The audio analyzer cannot be installed in the MS2840A.</p>	<ul style="list-style-type: none"> <li>➤ Monitor audio at internal speaker, Headphone Output connector, demodulation output connector (in any FM measurement mode except Wide FM measurement mode)</li> <li>➤ Monitor audio using connected USB Audio (requires separately sold speaker or headphone, Wide Band FM measurement mode not supported)</li> </ul>
<p>Analog Measurement Software only</p>		<ul style="list-style-type: none"> <li>➤ Monitor audio using connected USB Audio (requires separately sold speaker or headphone, Wide Band FM measurement mode not supported )</li> </ul>

### <Tx Test> Settings

Display Item	Outline
Result (Tx Measure)	RF Signal analysis results
RF Frequency	Carrier Frequency and Carrier Frequency Error
RF Power	RF Power
Deviation	Frequency Deviation (FM)
Radian	Phase Deviation (ΦM)
Depth	Modulation (AM)
DCS Code	DCS Code analysis results (FM)
AF Measure	Demodulated signal analysis results
AF Frequency	Demodulated frequency
Level	Demodulated signal rms level
Distortion, SINAD, THD	Demodulated frequency distortion
Graph Results	Time vs Level and Frequency vs Level for demodulated frequency

### <Tx Test> Filter Settings (for demodulated signal analysis)

Low Pass Filter	Off, 300 Hz, 3, 15, 20 kHz
High Pass Filter	Off, <1*, <20*, 50, 300, 400 Hz, 30 kHz *FM only
Weighting Filter	Off, CCITT, C-Message, CCIR 468, CCIR-ARM, A-Weighting
De-emphasis	Off, 25 μs, 50 μs, 75 μs, 500 μs, 750 μs

## <Tx Tests> Audio Analyzer MS2830A-018/118 Settings (Audio Generator Function)

**The following settings are supported when the Audio Analyzer MS2830A-018 (or 118) is installed.**

<The Sub Supply/Audio Revision 2\*1 specifications are presented below (shipped March 26, 2015)>

Output Signal	AF Tone	<p>Simultaneous output of up to 3 waveforms at any frequency                      Frequency: 10.0 to 50000.0 Hz (Guarantee Range: 20.0 to 25000.0 Hz)                      Level: [Output unit: mV rms, V rms, dBm]                      At 600 Ω termination when output impedance and output impedance reference set to 600 Ω                      Balanced: off, -63 dBm (equivalent to 0.5 mV rms) to +18 dBm (equivalent to 6.2 V rms)                      Unbalanced: off, -63 dBm (equivalent to 0.5m V rms) to +12 dBm (equivalent to 3.1 V rms)</p>
	DCS	<p>DCS Code: 000 to 777 (octal, 3 digit)                      DCS Polarity: Normal (non-inverted polarity output), Inverted (inverted polarity output)                      Level: [Output unit: mV p, V p]                      At 600 Ω termination when output impedance set to 600 Ω                      Balanced: off, 0.5 mV p to 3.5 V p                      Unbalanced :off, 0.5 m V p to 1.75 V p</p>
	White Noise (through ITU-T Rec.G.227 filter)	<p>Level: [Output unit: mV rms, V rms, dBm]                      At 600 Ω termination when output impedance and output impedance reference set to 600 Ω                      Balanced: off, -60 dBm (equivalent to 0.774 mV rms) to +6 dBm (equivalent to 1.545 V rms)                      Unbalanced: off, -60 dBm (equivalent to 0.774 mV rms) to 0 dBm (equivalent to 0.774 V rms)</p>
	DTMF	<p>Setting: 0 to 9, *, #, A to D (any one)                      Signal length: 1 to 2000 ms                      Level: [Output unit: mV p, V p]                      At 600 Ω termination when output impedance set to 600 Ω                      Balanced: off, 0.5 mV p to 1.5 V p                      Unbalanced: off, 0.5m V p to 0.75 V p</p>

\*1: <Sub Supply/Audio Revision Confirmation Method> (Sub Supply/Audio Revision is the MS2830A-018/118 printed-circuit board version.)

(1) MS2830A units with Sub Supply/Audio Revision 2 have a sticker marked 'A1' next to the main-frame serial number.

(2) The MS2830A Sub Supply/Audio Revision can be confirmed as follows:

Press [System Config ] → [F5] System Information → [F4] Board Revision View to list the Board Revisions; check the displayed Sub Supply/Audio Revision number. (It may be either 1 or 2.)

\*2: The relationship between the output level units and output level display is explained on the next slide.

## <Tx Tests> Audio Analyzer MS2830A-018/118 Settings (Audio Generator Function)

The following settings are supported when the MS2830A-018 (or 118) Audio Analyzer is installed.

Output Type	Balanced, Unbalanced
Output Impedance	Balanced: 100Ω, 600Ω Unbalanced: 50Ω, 600Ω
Output Impedance Reference	Sets the impedance reference used for converting power to dBm.
PTT (Push To Talk)	On/Off setting

### ◆ Relationship between Output Level Units and Output Level Display

From MS2830A firmware Package Version 7.03.00 \*1 (all units shipped from March 26, 2015), the relationship between the output units setting and output level display is as follows.

When output units set to <b>dBm</b>	<p>“Termination Power” is displayed. The power consumed by the termination resistance (0 dBm = 1 mW) is displayed. *Up to Package Version 7.02.00, the actual output level was 6 dB lower than the display.</p>
When output units set to <b>mV</b> or <b>V</b>	<p>“Open Circuit Voltage” is displayed.</p>

### <Output Impedance: At Unbalanced 600Ω>

#### Audio Generator function

Termination Power Display: 0dBm

Open Circuit Voltage Display: 1.55Vrms

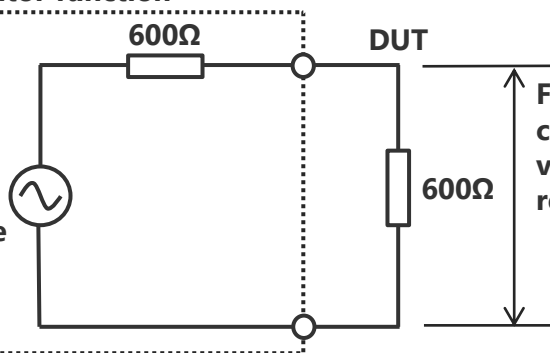

Finds power from half of open circuit voltage display (partial voltage at termination resistance (600 Ω)).

$$\frac{\left(\frac{1.55V_{rms}}{2}\right)^2}{600\Omega} = 1mW = 0dBm$$

\*1: <Firmware Confirmation Method>  
Confirm the MS2830A firmware using the following operation.

Press [System Config] → [F5] System Information → [F2] Software Version View, and check the Package Version displayed at the top right of the screen.

Switch to Tx measurement mode when performing Tx test.

## Tx Mode Screen

(With Audio Analyzer installed in MS2830A)

### (1): Measurement parameters

Displays set parameters

### (2): Result window

Displays measurement results for input RF signal frequency, level and modulation

\*Explained on following slides

### (3): Function menu

Displays functions executed by function keys

### (4): AF Measurement results (Tx-AF) window

Displays demodulated AF signal frequency, level, and distortion rate as graphs

### (5) Audio Generator window

Displays AF signal output settings when MS2830A-018/118 Audio Analyzer option installed

\*Explained on following slides

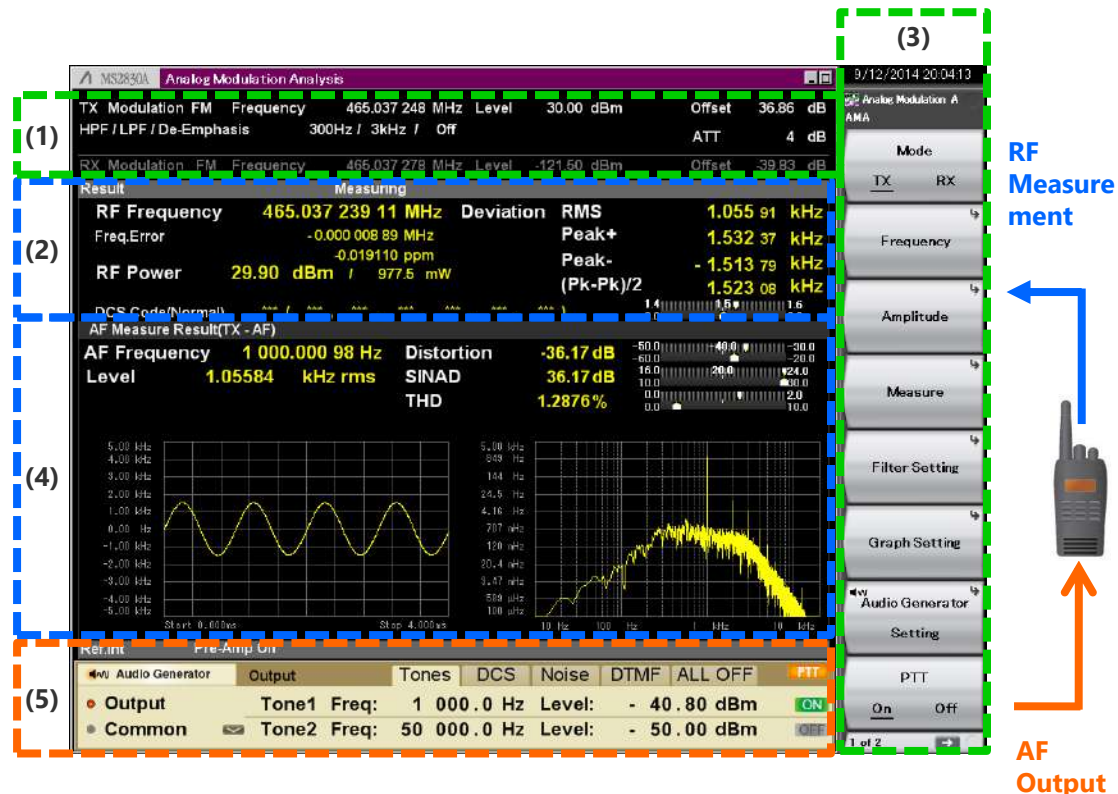

Set AF signal output and confirm radio Tx performance at one screen

Switch to Tx measurement mode when performing Tx test.

## Tx Mode Screen

(When Audio Analyzer not installed in MS2830A, or with MS2840A)

### (1): Measurement parameters

Displays set parameters

### (2): Results window

Displays measurement results for input RF signal frequency, level and modulation

\*Explained on following slides

### (3): Function menu

Displays functions executed by function keys.

### (4): AF Measurement results (Tx-AF) window

Displays demodulated AF signal frequency, level, and distortion rate as graphs

\*Explained on following slides



## Result Window (for FM)

	Result	Measuring			
(1)	RF Frequency	465.037 239 11 MHz	Deviation RMS	1.055 91 kHz	(3)
	Freq.Error	-0.000 008 89 MHz	Peak+	1.532 37 kHz	(6)
		-0.019110 ppm	Peak-	-1.513 79 kHz	(7)
(2)	RF Power	29.90 dBm / 977.5 mW	(Pk-Pk)/2	1.523 08 kHz	
(4)	DCS Code(Normal)	023 ( 340 , 766 , *** , *** , *** , *** )			(5)

### (1): RF Frequency

Displays difference between carrier frequency of measured signal and set frequency of Tx Frequency

### (2): RF Power

Displays measurement signal power results in dBm and Watt units when RF Power Set Reference is Off  
When RF Power Set Reference is set to On, the measured RF Power at that instant becomes the Reference Power and subsequent displayed RF Power results are referenced to that value

### (3): Deviation

Displays +Peak, -Peak, (+Peak to -Peak)/2, RMS results for measured signal frequency deviation in Hz units

### (4): DCS Code

Displays DSC code analysis results with octal notation in three digits when DCS Code Analysis ON  
The initial code of the displayed result is displayed when the detected code matches the 83 Standard Code defined by TIA-603-C. If there is no match, \*\*\* is displayed.  
Codes in parentheses display code matches other than the 83 Standard Code.

### (5): Meter displays

Displays measured signal Frequency Deviation (+Peak to -Peak)/2 results as meter when modulation setting is FM or Wide FM

*\*Explained on following slides*

### (6): Radian

Displayed when Modulation is set to  $\Phi$ M.  
Displays the +Peak, -Peak, (+Peak to -Peak)/2, and RMS result of phase transition of measured signal in radian unit.

### (7): Depth

Displayed when Modulation is set to AM. Displays the +Peak, -Peak, (+Peak to -Peak)/2, and RMS result of modulation index of measured signal in % unit.

### AF Measurement Results (TX-AF) Window

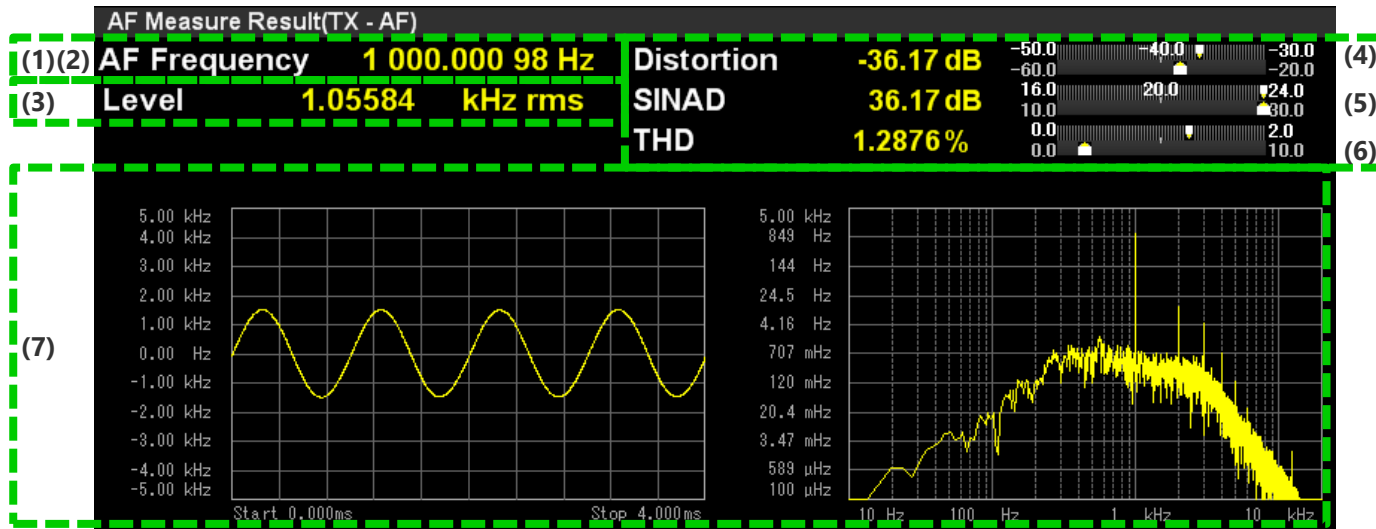

#### (1): AF Frequency

Displays maximum level of frequency from demodulated signal frequency spectrum in Hz units when [AF Frequency Reference] set to [Off]

#### (2): AF Freq. Error

Displays maximum level of frequency from demodulated signal frequency spectrum relative to reference value when [AF Frequency Reference] set to [On]

#### (3): Level

Displays level of above-described AF Frequency in kHz rms at FM, radian rms at  $\Phi$ M, and % at AM

#### (4): Distortion

Displays distortion measurement results as meter

#### (5): SINAD

Displays SINAD measurement results as meter

#### (6): THD

Displays THD measurement results as meter

#### (7): Measurement results graph

Displays demodulation signal Time vs Level and Frequency vs Level

\*Explained on following slides

## Audio Generator Window

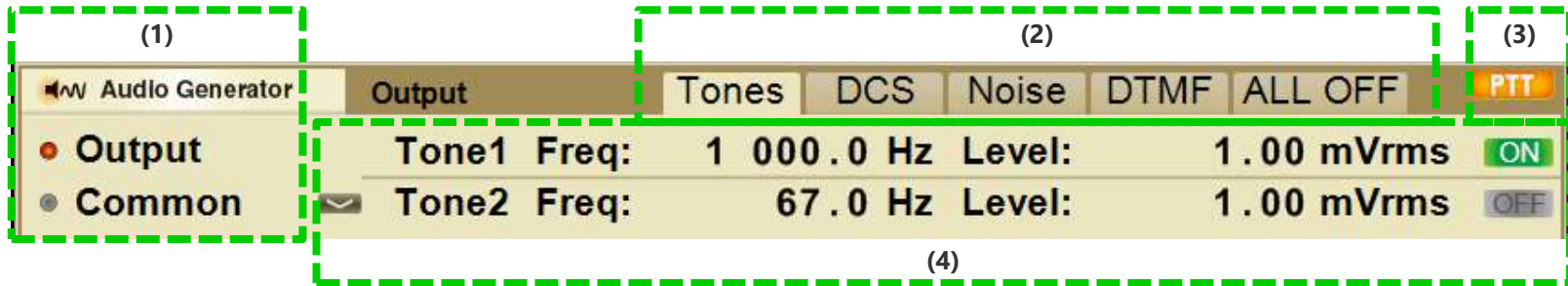

### (1): Switches Output/Common

Performs switching between Output and Common. At switching, parameters displayed in (4) change.

Output: Displays parameters for selected waveform

Common: Displays AF signal type, impedance, etc.

### (2): Waveform switching

Switches waveform

### (3): PTT Status display

Displays PTT (Push To Talk) On/Off

### (4): Parameter settings

Sets output AF signal frequency and level

# <Tx Test> MX269018A Tx Mode Screen (6/7)

Tx Test

## Alphanumeric Magnification Function

Magnification of items displayed on the screen in the Tx mode supports easy reading of text and numeric values. This helps prevent errors when reading numeric values and shortens evaluation times when evaluating wireless equipment operation while watching the screen. In addition, screens can be switched by both button and remote control operation.

### Magnification of Carrier Related Items (Carrier)

Standard Screen

Function Menu (Display Mode Setting)

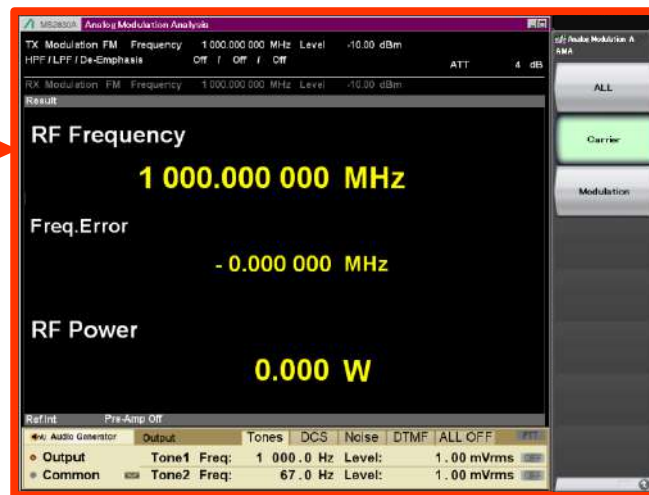
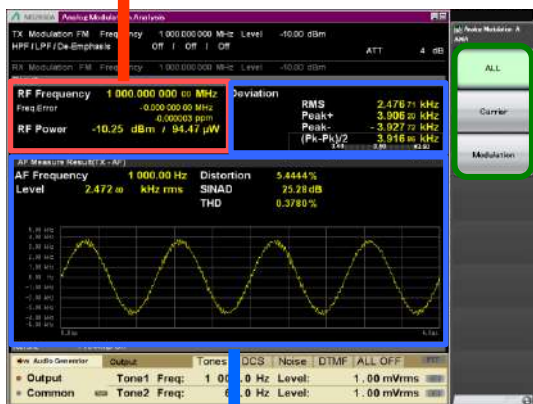

<Magnified Items>

- ✓ RF Frequency
- ✓ Frequency Error
- ✓ RF Power

### Magnification of Modulation Related Items (Modulation)

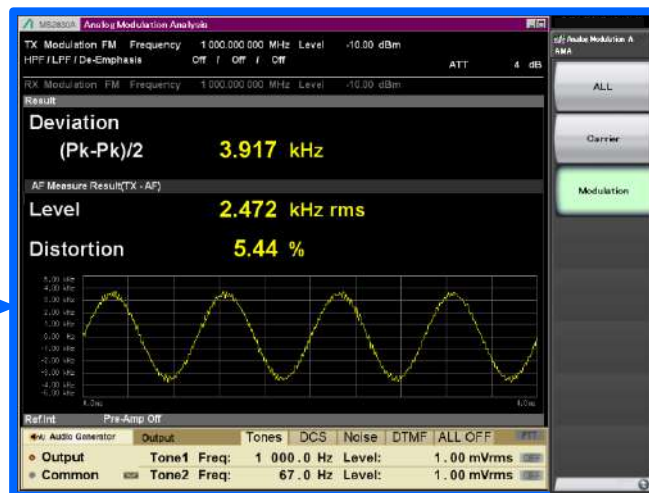
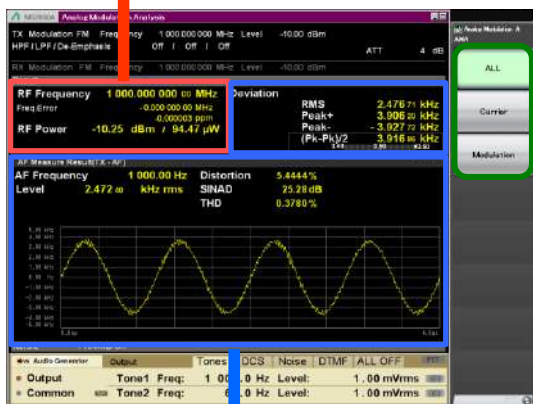

<Magnified Items>

- ✓ Any one of Deviation<sup>\*1</sup>, Depth<sup>\*2</sup>, and Radian<sup>\*3</sup>
- ✓ AF Frequency Level
- ✓ Any one of Distortion, SINAD, and THD

\*1: At FM or Wide FM

\*2: At AM

\*3: At ΦM

### Simultaneous AF signal output and spurious/OBW measurements

When the Audio Analyzer MS2830A-018/118 is installed, the audio generator function can be used simultaneously with other applications (spectrum analyzer, signal analyzer, etc.). This can be used to measure the spurious and occupied bandwidth (OBW) of an RF signal output from a radio to which an AF signal (such as white noise) is being input.

The Noise Output function can be used to switch easily between an AF tone (1 kHz, 1.25 kHz) and a white noise signal (ITU-T Recommendation G.227). Pre-registering the output level offset and setting Offset Output to On outputs a signal with the registered signal added (reduced). Use of this function makes it easy to switch the output signal, such as outputting a 1 kHz AF tone first and then outputting a white noise signal (ITU-T Recommendation G.227). When outputting a white noise signal (ITU-T Recommendation G.227), setting the Offset Output function to On makes it easy to output a signal with a 10 dB higher level than when outputting the AF tone.

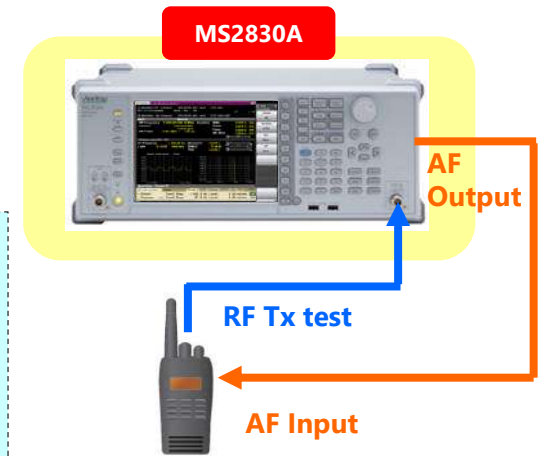

- ✓ AF tone (1 kHz, 1.25 kHz)
- ✓ White noise (ITU-T Recommendation G.227)

#### (1): Other application window

#### (2): Audio Generator window

This displays a reduced-size Audio Generator window where the output AF signal type, frequency and level can be set.

AF tone (3 waveforms max.), DCS, White noise (ITU-T Recommendation G.227) and DTMF AF signals can be output.

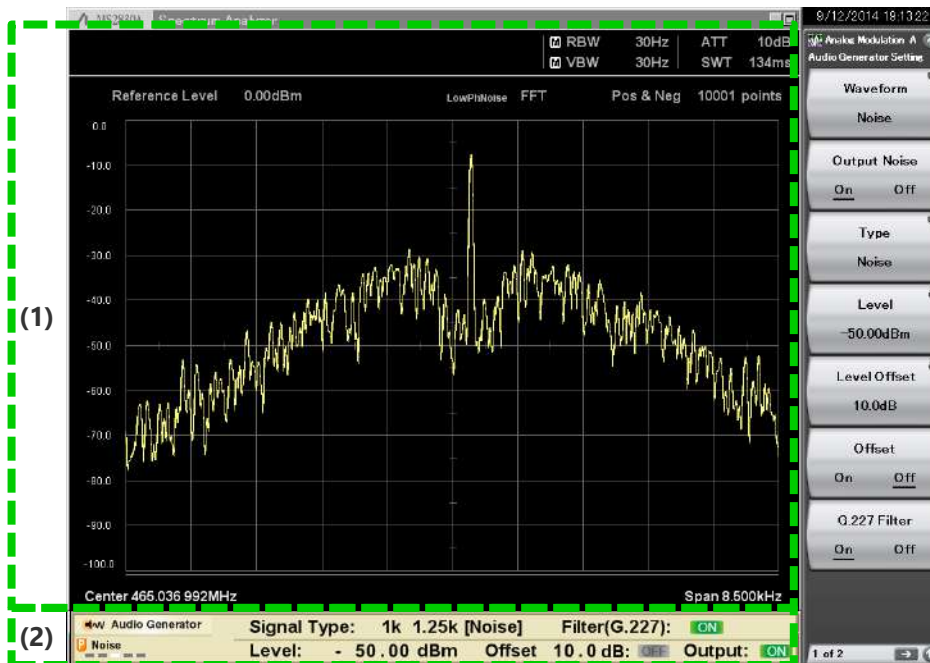

### <Rx Test> Measurement Items

The following measurement results are displayed when the Audio Analyzer is installed in the MS2830A.

Displayed Item	Outline
AF Measure Result	AF Signal analysis results
AF Frequency	AF Frequency
Level	AF Signal rms level
SINAD, THD, THD+N	AF Signal distortion
Graph Result	AF Signal Time vs Level and Frequency vs Level

### <Rx Test> Audio Input Settings

The following settings are supported when the Audio Analyzer is installed in the MS2830A.

Filter	Low Pass Filter	Off, 3, 15, 20, 30, 50 kHz
	High Pass Filter	Off, 20, 50, 100, 300, 400 Hz, 30 kHz
	Weighting Filter	Off, CCITT, C-Message, CCIR 468, CCIR-ARM, A-Weighting
Input Method	Balanced, Unbalanced	
Input Range	50 mV peak, 500 mV peak, 5 V peak, 50 V peak	
Level Unit	Vrms, dBu, dBV, W, dBm	
Input Impedance Reference	Sets the impedance reference used for converting AF Level measurement value into power of W, dBm.	
Relative Value Display	Input level: Displays value relative to reference value (Using the AF Level measurement result as a 0 dB reference (when this function is set to On), this displays the relative value results of subsequent AF Level measurements.) Input frequency: Displays value relative to reference value (Reference Value: 20 Hz to 60 kHz, Units: ppm, %, Hz)	
Level Display	Displays peak frequency level and level for all bands	

### <Rx Test> Analog Signal Generator Output Settings

The following settings are supported when the Analog Signal Generator is installed in the MS2830A/MS2840A.

Output Frequency	Frequency setting Range: 100 kHz to 3000 MHz, Frequency setting resolution: 1 Hz
Output Units	dBm, dB $\mu$ V (EMF), dB $\mu$ V (Term)
Output Level	<p>With output in dBm units:</p> <ul style="list-style-type: none"> <li>-136 to +15 dBm (Rx frequency &gt;25 MHz)</li> <li>-136 to -3 dBm (Rx frequency <math>\leq</math>25 MHz)</li> </ul> <p>With output in dB<math>\mu</math>V (EMF):</p> <ul style="list-style-type: none"> <li>-22.99 dB<math>\mu</math>V to +128.01 dB<math>\mu</math>V (Rx frequency &gt;25 MHz)</li> <li>-22.99 dB<math>\mu</math>V to +110.01 dB<math>\mu</math>V (Rx frequency <math>\leq</math>25 MHz)</li> </ul> <p>With output in dB<math>\mu</math>V (Term) units:</p> <ul style="list-style-type: none"> <li>-29.01 dB<math>\mu</math>V to +121.99 dB<math>\mu</math>V (Rx frequency &gt;25 MHz)</li> <li>-29.01 dB<math>\mu</math>V to +103.99 dB<math>\mu</math>V (Rx frequency <math>\leq</math>25 MHz)</li> </ul>
Output Level Offset	-100.00 to 100.00 dB
Modulation Output	FM, $\Phi$ M, AM

## <Rx Test> Analog Signal Generator Output Settings

The following settings are supported when the Analog Signal Generator is installed in the MS2830A/MS2840A.

<b>Internal Modulation Signal Source (AF signal)</b>	AF Tone	Simultaneous output of up to 2 or 3* waveforms at any frequency 20.0 to 40000.0 Hz Tone Deviation (FM): 0.0 to 100000.0 Hz Tone Radian (ΦM): 0.00 to 50.00 rad Tone Depth (AM): 0% to 100%
	DCS	At FM modulation output DCS Code: 000 to 777 (octal, 3 digit) DCS Polarity: Normal (polarity not inverted), Inverted (polarity inverted) DCS Deviation: 0.0 to 100000.0 Hz
	USER	At Wave audio file output Frequency: 20.0 to 40000.0 Hz Tone Deviation (FM): 0.0 to 100000.0 Hz Tone Radian (ΦM): 0.00 to 50.00 rad Tone Depth (AM): 0% to 100%

\*Outputs up to 3 waveforms when MS2830A-018/118 Audio Analyzer installed

The Analog Signal Generator has an internal modulation signal source.

The Analog Signal Generator has up to three internal modulation signal sources for AF tones\*1, and one internal signal modulation signal source for DCS. For example, the operation of an analog radio can be confirmed using the following combination.

- (1) AF + AF + AF (1 kHz audio signal + Tone squelch signal + voice signal of any frequency)
- (2) AF + AF + DCS (1 kHz audio signal + voice signal of any frequency + DCS signal)
- (3) AF (Wave audio format)\*2

\*1: Two when MS2830A-018/118 Audio Analyzer is not installed  
\*2: The internal modulation signal source can be set to output Wave audio format files as well.

An RF signal, such as DTMF (Dual Tone Multiple Frequency), can be output.

The limitations are as follows:

- Linear PCM file (It is not possible to support ADPCM and the compressed format for enhanced PCM.)
- Monaural or stereo reproduction (Multi-channel is not supported. The left channel is used to reproduce stereo.)
- 8 or 16-bit sampling quantization rate (full-scale at modulation and modulation depth set)
- Data replay of 10 s or less
- 44.1 kHz, 48 kHz, or 96 kHz sampling frequency

Note: Even if a Wave file meets the above specifications, sometimes the file cannot be loaded.

### DCS Code setting

The screenshot shows the 'Digital Code Squelch Data' dialog box. It has two main sections: 'Octal Code' and 'Binary Code (Custom)'. In the 'Octal Code' section, the 'Code' field is set to '023' and is labeled '(Standard)'. The 'Code select mode' has three radio buttons: 'Standard 83' (selected), 'Standard 104', and 'All codes'. There is an 'Octal to Binary' button. In the 'Binary Code (Custom)' section, the 'Binary' field contains '0000000000000000000010011 (023)'. Above the binary digits are labels: 'b', 'a', '8', '8', '7', '6', '5', '4', '3', '2', '1', '9', '8', '7', '6', '5', '4', '3', '2', '1', and '8 error bit(s)'. Below the binary field are three buttons: 'Parity' (yellow), 'Fixed' (blue), and 'DCS Code' (green). The 'Inverted' field shows '1111111111111111111101100'. At the bottom, there are two radio buttons for 'Compare error to': 'Octal Code' (selected) and 'DCS Code field of Binary Code'. There are 'Set' and 'Cancel' buttons at the bottom right.

DCS Code can be set to Binary or Octal Code. Set DCS Code to Octal Code usually, but set to Binary Code for adding errors to DCS Code.

# Internal Modulation Signal Source (Analog Signal Generator)

(2/2)

The AF signals from the internal modulation source are generated in the following combinations.

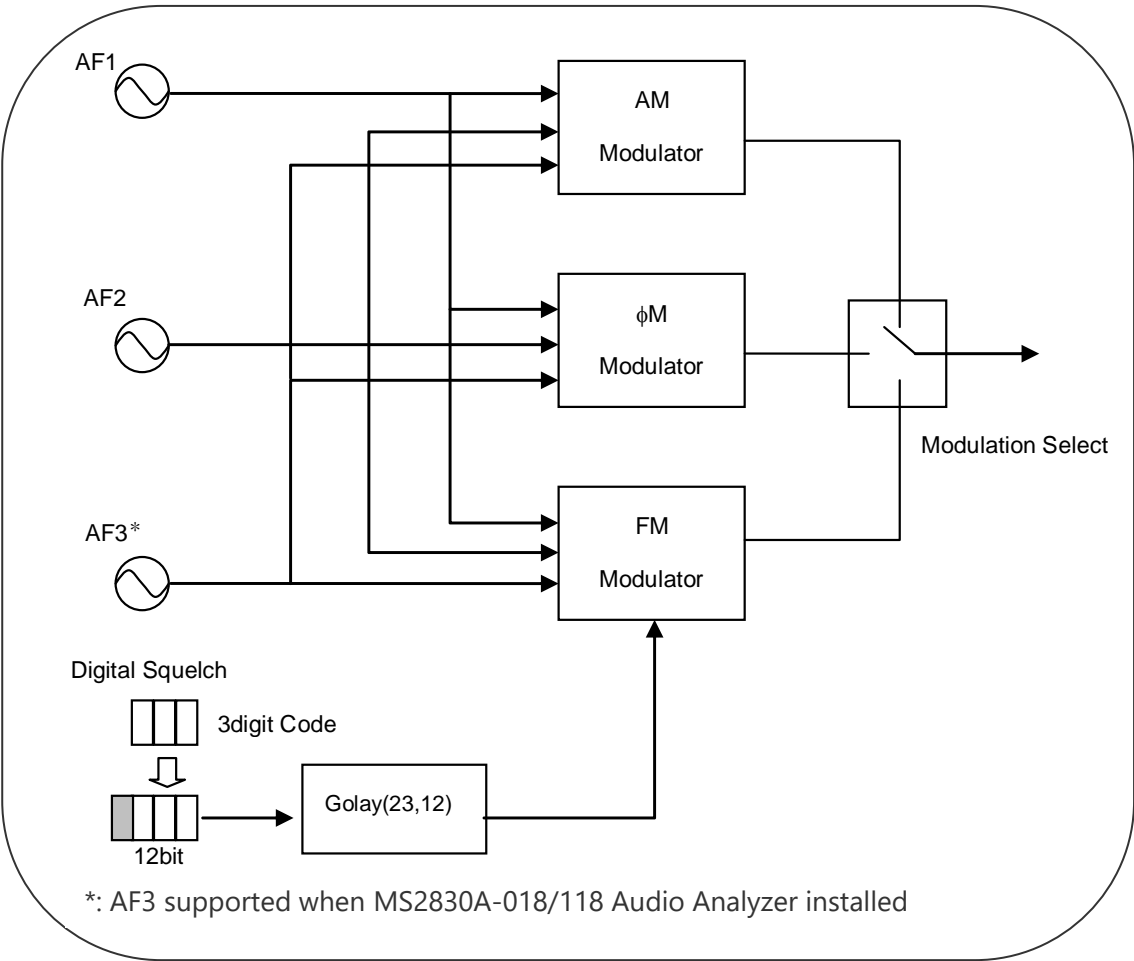

- There are three AF signal sources (AF1, AF2, AF3) for generating tone signals\* and one signal source for generating the DCS signal.
- The AF3 and DCS signals can be output simultaneously.
- A Wave audio format file can be used instead of a tone signal for AF1. In this case, the AF2 tone, AF3 tone, and DCS (Digital Code Squelch) settings are set to Off automatically.

## Outline of AF Signal Generation Method

Switch to Rx measurement mode when performing Rx test.

## Rx Mode Screen

(With Analog Signal Generator and Audio Analyzer installed in MS2830A)

### (1): Measurement parameters

Displays set parameters

### (2): Audio Analyzer settings window

Sets input AF signal analysis conditions

### (3): AF Measurement results window

Displays input AF signal frequency, level, and distortion as graphs

### (4): Function menu

Displays functions executed by function keys

### (5): RF Signal Generator window

Displays AF signal settings and output RF signal frequency, level, and modulation settings

\*Explained on following slides



The Analog Signal Generator settings and AF signal analysis results can be confirmed on one screen.

# <Rx Test> MX269018A Rx Mode Screen (2/4)

Rx Test

Switch to Rx measurement mode when performing Rx test.

## Rx Mode Screen

(With Analog Signal Generator installed in MS2830A/MS2840A)

### (1): Measurement parameters

Displays set parameters

### (2): RF Setting window

Displays output RF signal frequency, level, and modulation settings

### (3): Function menu

Displays functions executed by function keys

### (4): AF Setting window

Displays modulation AF signal settings

The screenshot displays the MS2830A Analog Modulation Analysis interface. The top section shows TX Modulation FM with Frequency 1 000.000 000 MHz and Level -10.00 dBm. The RX Modulation section shows FM with Frequency 1 000.000 000 MHz and Level -13.99 dBμV (EMF). The RF Setting window displays RF Frequency 1 000.000 000 MHz, RF Level -13.99 dBμV (EMF) at 199.5 aW, Modulation FM, and Deviation 0.000 0 kHz. The AF Setting window shows Signal None(CW), AF1 Tone 1000.0 Hz, AF2 Tone 67.0 Hz, DCS Code 023, and Deviation 3.500 0 kHz. The function menu on the right includes Mode (TX/RX), Frequency, Amplitude, Measure, AF Setting, Signal Output (Restart), and Signal Modulation (On/Off). An Audio Analyzer is connected to the device, and an RF Output signal is shown.

Switch to Rx measurement mode when performing Rx test.

## Rx Mode Screen

(With Audio Analyzer installed in MS2830A)

### (1): Measurement parameters

Displays set parameters

### (2): Audio Analyzer Setting window

Sets input AF signal analysis conditions

### (3): Function menu

Displays functions executed by function keys

### (4): AF Measurement results window

Displays input AF signal frequency, level and distortion as graphs\*



\*: Two types of graph (Time vs. Level and Frequency vs. Level) are provided for analysis of AF signals

## RF Signal Generator Window

The screenshot shows the RF Signal Generator window with the following elements:

- (1)** AF1 +AF2 +AF3 | AF1 +AF2 +DCS | User Wave
- (2)** RF Frequency: 465.037 278 MHz | Level: -121.50 dBm
- (3)** AF1 Frequency: 1 000.0 Hz | Deviation: 1.500 0 kHz p
- (3)** AF2 Frequency: 67.0 Hz | Deviation: 0.500 0 kHz p
- (4)** FM MOD
- (5)** PTT
- Output: On
- Modulation: On

### (1): Displays AF signal type

Switches AF signal type and highlights selected AF signal type with parameters in (3)

### (2): Sets RF signal

Selects RF signal setting mode

### (3): Sets AF signal

Selects AF signal setting mode

### (4): Modulation display

Displays output signal modulation type

### (5): PTT Status display

Displays PTT On/Off setting

# Useful Meter Displays

Tx Test

Rx Test

## Convenient Meter Displays for Rx Sensitivity Tests and Frequency Deviation Measurements

Both numeric tables and convenient meter displays are provided for checking and adjusting Frequency Deviation, SINAD, THD, and Distortion measurements. Using these meters makes it easy to read, intuitively understand, and fine-adjust results for Frequency Deviation (FM) and SINAD at Tx and Rx tests, respectively.

### Frequency Deviation Meter

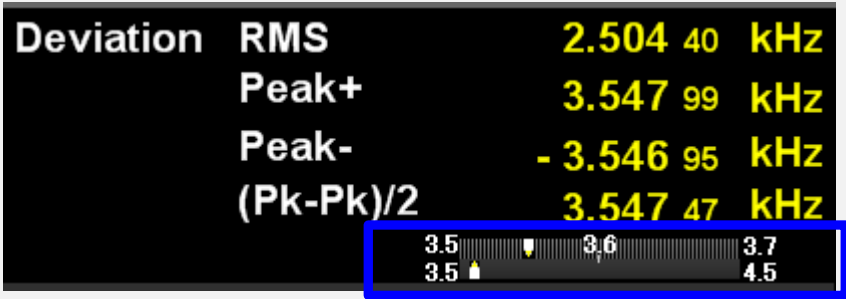

### SINAD (THD/THD+N) Meter



The meters are split into upper and lower parts; setting the upper part narrows the range while the lower part widens the range. The upper part can be used to fine-tune over a narrow range approaching the required value while confirming the wide-ranging variation at the lower meter.

### Pass/Fail Displays

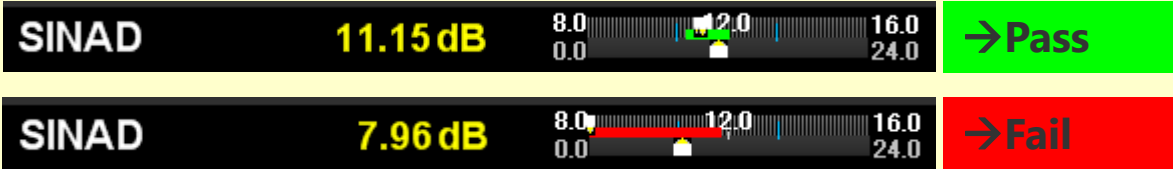

Pass/fail evaluations are displayed at all meters by setting the values for the pass range and number of measurement times.

←→ Pass Range

# <Tx Test> Audio Signal Graph Displays

Displays Two Types of Graph for Audio Signal Analysis

Two convenient types of graph (Time vs. Level and Frequency vs. Level) are provided for analysis of demodulation signals at Tx tests.

## Tx Mode Screen Demodulation Signal Graphs (Analog Measurement Software MX269018A standard function)

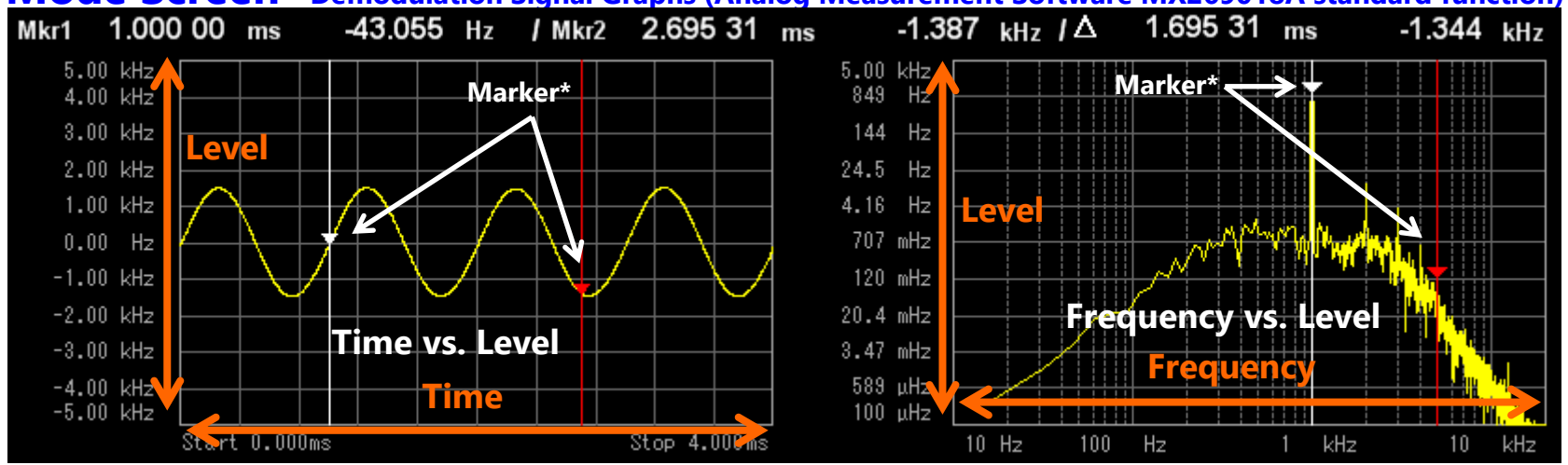

Time axis	Supports scale setting (1 to 200 ms)
Level axis	Linear scale only <Range setting> <ul style="list-style-type: none"> <li>➤ FM: Auto and Fixed</li> <li>➤ ΦM: Auto</li> <li>➤ AM: Auto</li> </ul>
Marker	Convenient markers (Marker 1, Marker 2, Delta marker)

Frequency axis	Supports selection of Log and linear scales <Range setting> <ul style="list-style-type: none"> <li>➤ Log scale: 10 Hz to 50000 Hz</li> <li>➤ Linear scale: 10 Hz to 50 kHz</li> </ul>
Level axis	Log scale only <Range setting> <ul style="list-style-type: none"> <li>➤ FM: 0.0001 to 1000 kHz</li> <li>➤ ΦM: 0.0001 to 1000 rad</li> <li>➤ AM: 0.0001 to 1000 %</li> </ul>
Marker	Convenient markers (Marker 1, Marker 2, Delta marker, Peak Search, Next Peak Search)

# <Rx Test> Audio Signal Graph Displays

Displays Audio Signal Analysis as Two Types of Graph

Two convenient types of graph (Time vs. Level and Frequency vs. Level) are provided for analysis of AF signals at Rx tests using the MS2830A-018/118 Audio Analyzer.

## Rx Mode Screen (Displayed when Audio Analyzer installed)

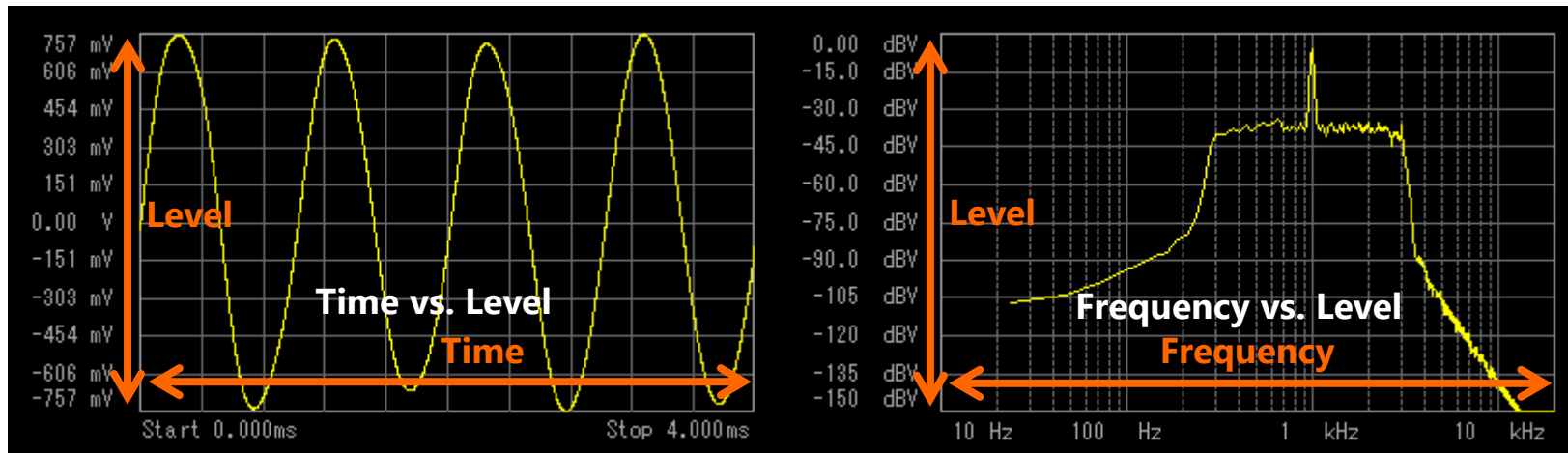

Time axis	Supports scale setting (1 to 200 ms)
Level axis	Only linear scale Auto or fixed range setting <Range setting> ➤ Auto: Min. Range $\pm 0.5$ mV to $\pm 1$ V ➤ Fixed: Range $\pm 0.5$ mV to $\pm 20$ V
Markers	Convenient markers (Marker 1, Marker 2, Delta marker)

Frequency axis	Supports selection of Log and linear scales <Range setting> ➤ Log scale: 10 Hz to 50000 Hz ➤ Linear scale: 10 Hz to 50 kHz
Level axis	Only linear scale <Range setting> ➤ -200 to 50 dBV
Markers	Convenient markers (Marker 1, Marker 2, Delta marker, Peak Search, Next Peak Search)

# Demodulated Audio Output

Demodulated Audio Output

The Analog Measurement Software MX269018A supports demodulated audio output. The RF signal from the radio equipment is demodulated and the audio can be monitored.

1. Outputs AF signal from Audio Generator
2. Outputs RF signal from radio equipment
3. Demodulates RF signal in MX269018A
4. Outputs demodulated audio

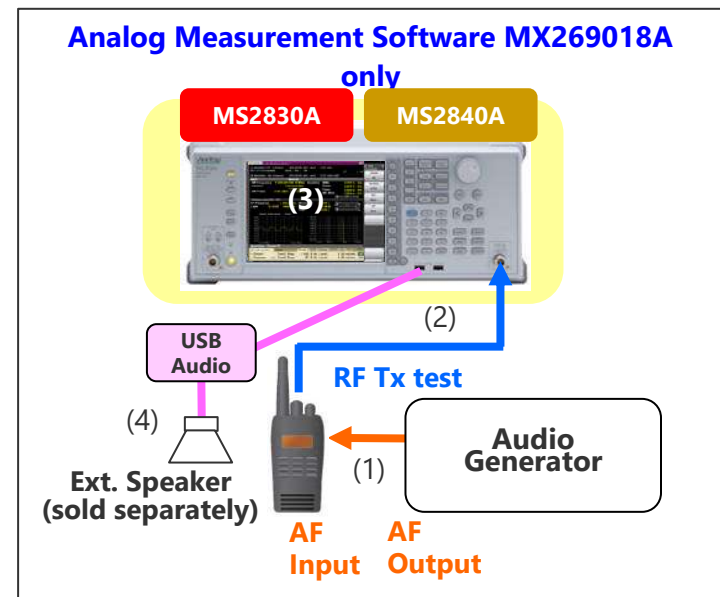
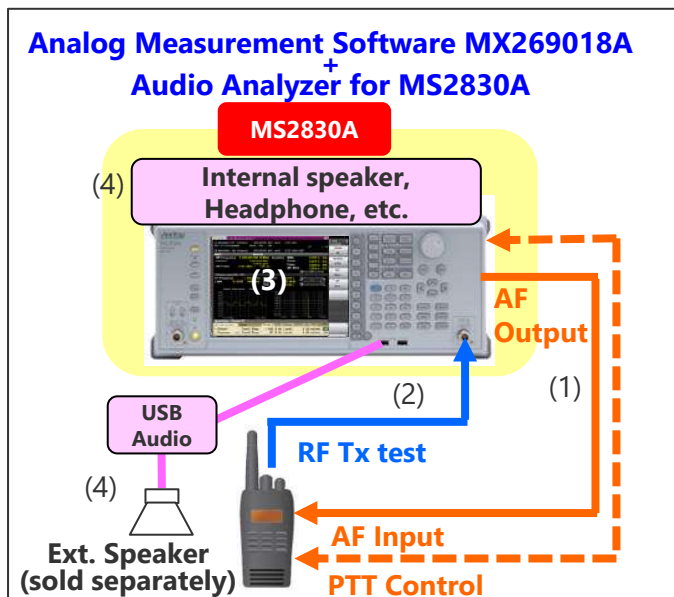

Option	Demodulation Output Function	Explanation	Supported Modulation Methods
Analog Measurement Software MX269018A	A0086D USB Audio*1	Monitor audio using connected USB Audio (requires separately sold speaker or headphone)	FM, ΦM, AM (Wide Band FM measurement not supported)
Audio Analyzer MS2830A-018/118	Internal speaker*2		FM (Wide Band FM measurement not supported)
	Headphone Output connector*2	3.5 mm phone jack (2-pole, monaural)	
	Demodulation Output connector*2	BNC-J, Impedance: 600Ω, Output: -10 dBm ±0.2 dB (frequency deviation = 3.5 kHz)	

\*1: Screen display stops during monitoring at USB Audio  
\*2: Output audio without AF filtering

# Section 3

- **Specifications**

**Analog Measurement Software**

**Analog Signal Generator**

**Audio Analyzer**

# MX269018A Analog Measurement Software Specifications (1/4)

Signal Analyzer		MS2840A	MS2830A
<b>Tx Measurements</b>		When Input Level proper compared with the input signal is set as long as it doesn't provide separately by each item, the following standards are guaranteed.	
		The Tx measurement specifications apply to the MS2840A, and the MS2830A with built-in MS2830A-062/066 Low Phase Noise Performance Option.	
		No Audio Analyzer option	Without MS2830A-018/118 Audio Analyzer
			With MS2830A-018/118 Audio Analyzer
Common Specification	Target Signal	FM, $\Phi$ M, AM signal	
	Frequency Range	100 kHz to the upper limit of the main unit (At Wide Band FM measurement : 10 MHz to 2700 MHz)	
	Level Range	-15 to +30 dBm (Preamp Off, or Preamp not installed) -25 to +10 dBm (Preamp On)	
	Carrier Frequency Accuracy	At 18° to 28°C, after calibration $\pm$ (Accuracy of reference frequency $\times$ Carrier frequency + 1) Hz	
FM Measurement	FM measurement performance under following conditions: 100 kHz $\leq$ Frequency $\leq$ 2700 MHz (At FM measurement) 10 MHz $\leq$ Frequency $\leq$ 2700 MHz (At Wide Band FM measurement)		
	Frequency Deviation (FM)	0 < Frequency Deviation $\leq$ 20 kHz 20 kHz < Frequency Deviation $\leq$ 40 kHz (nominal)	
	Frequency Deviation (Wide Band FM)	0 < Frequency Deviation $\leq$ 20 kHz 20 kHz < Frequency Deviation $\leq$ 1 MHz (nominal)	
	Demodulation Frequency Range	20 Hz to 20 kHz	
	Frequency Deviation Accuracy	1% of indicated value $\pm$ Residual FM	
	Residual FM	3.35 Hz rms, S/N: > 50 dB (1.5 kHz Deviation, Demodulation Band: 0.3 kHz to 3 kHz)	
	Demodulation Distortion	0.3% (Demodulation Frequency: 1 kHz, Frequency Deviation: 5 kHz, Demodulation Band: 0.3 kHz to 3 kHz)	
	DCS Measurement Function	Digital Code Squelch demodulated result display	
	$\Phi$ M Measurement	$\Phi$ M measurement performance under following conditions: 100 kHz $\leq$ Frequency $\leq$ 2700 MHz	
$\Phi$ M Deviation		0 to (20 kHz/Demodulation Frequency [Hz]) rad	
Demodulation Frequency Range		20 Hz to 20 kHz	
$\Phi$ M Deviation Accuracy		1% of indicated value $\pm$ Residual $\Phi$ M	
Residual $\Phi$ M		0.01 rad rms (Demodulation band: 0.3 kHz to 3 kHz)	
Demodulation Distortion		1% (Demodulation band: 0.3 kHz to 3 kHz)	

# MX269018A Analog Measurement Software Specifications (2/4)

Signal Analyzer		MS2840A	MS2830A
<b>Tx Measurements</b>		When Input Level proper compared with the input signal is set as long as it doesn't provide separately by each item, the following standards are guaranteed. The Tx measurement specifications apply to the MS2840A, and the MS2830A with built-in MS2830A-062/066 Low Phase Noise Performance Option.	
		No Audio Analyzer option	Without MS2830A-018/118 Audio Analyzer
		With MS2830A-018/118 Audio Analyzer	
AM Measurement		AM measurement performance under following conditions: 100 kHz ≤ Frequency ≤ 2700 MHz	
AM		0% to 98%	
Demodulation Frequency Range		20 Hz to 20 kHz	
AM Accuracy		1% of indicated value ± Residual AM	
Residual AM		0.3% (Demodulation band: 0.3 kHz to 3 kHz)	
Demodulation Distortion		0.3% (Demodulation band: 0.3 kHz to 3 kHz)	
Filter		300 Hz, 3, 15, 20 kHz	
HPF		<1*, <20*, 50, 300, 400 Hz, 30 kHz *FM only	
Weighting Filter		CCITT, C-Message, CCIR 468, CCIR-ARM, A-Weighting	
De-emphasis		25 μs, 50 μs, 75 μs, 500 μs, 750 μs,	
Amplitude Measurement		At 18° to 28°C, after calibration, with input attenuator ≥10 dB and input signal in measurement level range and less than Input level ±0.5 dB (Preamp Off, or Preamp not installed) Transmit Power Accuracy based on MS2830A main frame Absolute Amplitude Accuracy	
Demodulation Monitor (Demodulation Output)		FM/ΦM/AM: Output demodulated signal to USB audio equipment connected to MS2830A/MS2840A USB terminal. (Wide Band FM measurement not supported)	FM/ΦM/AM: Output demodulated signal to USB audio equipment connected to MS2830A USB terminal. (Wide Band FM measurement not supported) FM: Internal speaker, 3.5 mm phone jack or Demodulation Output connector (Wide Band FM measurement not supported)

# MX269018A Analog Measurement Software Specifications (3/4)

Signal Analyzer		MS2840A	MS2830A
<b>Rx Power Measurement</b>		This function is enabled either when the MS2830A/MS2840A-088 3.6 GHz Analog Signal Generator is installed, or when the MS2830A/MS2840A-020/021 Vector Signal Generator and MS2830A/MS2840A-022 Low Power Extension for Vector Signal Generator and MS2830A/MS2840A-029 Analog Function Extension for Vector Signal Generator are installed.	
		No Audio Analyzer option	without MS2830A-018/118 Audio Analyzer with MS2830A-018/118 Audio Analyzer
RF Signal Output		The performance specifications are for the MS2830A/MS2840A-088 /188 or MS2830A/MS2840A-020/021 when the MS2830A/MS2840A-029 is installed.	
Frequency Setting Range		FM, $\Phi$ M, AM : 100 kHz to 3000 MHz	
Frequency Setting Resolution		1 Hz	
Output Setting Level		-136 to +15 dBm (RX frequency > 25 MHz) -136 to -3 dBm (RX frequency $\leq$ 25 MHz)	
FM	Frequency Deviation Setting Range	0 to 100 kHz	
	Frequency Deviation Setting Resolution	0.1 Hz	
	Frequency Deviation Accuracy	$\pm 1\%$ of a setting value (residual FM excluded)	
	Internal Modulation Signal Source	AF Tone Source $\times$ 2 Digital Code Squelch Signal Generator	AF Tone Source $\times$ 3 Digital Code Squelch Signal Generator
	Internal Modulation Frequency Range	Tone Frequency: 20 Hz to 40 kHz	
	Internal Modulation Frequency Resolution	0.1 Hz, Setting value $\pm 3$ Hz on use of Digital Code Squelch signal	
	DCS Code Setting Range	DCS Code: 000 to 777 (octal, 3 digit)	
$\Phi$ M	Phase Deviation Setting Range	Settable with the range of 0 to 50.0 rad (internal modulation frequency $\times$ phase deviation) < 100 k Hz	
	Phase Deviation Setting Resolution	0.01 rad	
	Phase Deviation Accuracy	$\pm 1\%$ of a setting value (residual $\Phi$ M excluded)	
	Internal Modulation Signal Source	AF Tone Source $\times$ 2	AF Tone Source $\times$ 3
	Internal Modulation Frequency Range	Tone Frequency: 20 Hz to 40 kHz	
	Internal Modulation Frequency Resolution	0.1 Hz	

# MX269018A Analog Measurement Software Specifications (4/4)

Signal Analyzer		MS2840A	MS2830A
<b>Rx Power Measurement</b>		This function is enabled either when the MS2830A/MS2840A-088 3.6 GHz Analog Signal Generator is installed, or when the MS2830A/MS2840A-020/021 Vector Signal Generator and MS2830A/MS2840A-022 Low Power Extension for Vector Signal Generator and MS2830A/MS2840A-029 Analog Function Extension for Vector Signal Generator are installed.	
		No Audio Analyzer option	without MS2830A-018/118 Audio Analyzer with MS2830A-018/118 Audio Analyzer
AM	Modulation Setting Range	0 to 100%	
	Modulation Setting Resolution	1%	
	Modulation Accuracy	± 1% of a setting value (residual AM excluded)	
	Internal Modulation Signal Source	AF Tone Source x 2	AF Tone Source x 3
	Internal Modulation Frequency Range	Tone Frequency: 20 Hz to 40 kHz	
	Internal Modulation Frequency Resolution	0.1 Hz	

# MX269018A Analog Signal Generator Specifications (1/1)

Analog Signal Generator Option	MS2840A-029/129/088/188	MS2830A-029/088/188																
Max. reverse input	0 Vdc (max.) +18 dBm (<20 MHz), +30 dBm (≥20 MHz)																	
Function/Performance	The following specifications (see MS2840A brochure) are added to or changed from the specifications when the MS2840A-020/021 and MS2840A-022 are installed	The following specifications (see MS2830A brochure) are added to or changed from the specifications when the MS2830A-020/021 and MS2830A-022 are installed.																
Frequency Setting Range	FM, ΦM, AM : 100 kHz to 3000 MHz																	
Frequency Setting Resolution	1 Hz																	
Output Setting Level	-136 to +15 dBm (RF frequency > 25 MHz) -136 to -3 dBm (RF frequency ≤ 25 MHz)																	
Output Level Accuracy	with MS2830A-029/088/188, with MS2840A-029/129/088/188,CW, 18° to 28°C																	
	<table border="1"> <thead> <tr> <th></th> <th>Output level [p](dBm)</th> </tr> </thead> <tbody> <tr> <td>±3.0dB (typ., 100kHz ≤ f &lt; 250kHz)</td> <td>-110 ≤ p ≤ -3</td> </tr> <tr> <td>±1.0dB (typ., 250kHz ≤ f ≤ 25MHz)</td> <td>-110 ≤ p ≤ -3</td> </tr> <tr> <td>±1.0dB (typ., 25MHz &lt; f &lt; 100MHz)</td> <td>-110 ≤ p ≤ +4</td> </tr> <tr> <td>±0.5dB (typ., 100MHz ≤ f &lt; 375MHz)</td> <td>-110 ≤ p ≤ +4</td> </tr> <tr> <td>±0.5dB (375MHz ≤ f ≤ 3GHz)</td> <td>-110 ≤ p ≤ +4</td> </tr> <tr> <td>±1.0dB (100MHz ≤ f ≤ 3GHz)</td> <td>-120 ≤ p &lt; -110</td> </tr> <tr> <td>±1.0dB (typ., 100MHz ≤ f ≤ 3GHz)</td> <td>-127 ≤ p &lt; -120</td> </tr> </tbody> </table>			Output level [p](dBm)	±3.0dB (typ., 100kHz ≤ f < 250kHz)	-110 ≤ p ≤ -3	±1.0dB (typ., 250kHz ≤ f ≤ 25MHz)	-110 ≤ p ≤ -3	±1.0dB (typ., 25MHz < f < 100MHz)	-110 ≤ p ≤ +4	±0.5dB (typ., 100MHz ≤ f < 375MHz)	-110 ≤ p ≤ +4	±0.5dB (375MHz ≤ f ≤ 3GHz)	-110 ≤ p ≤ +4	±1.0dB (100MHz ≤ f ≤ 3GHz)	-120 ≤ p < -110	±1.0dB (typ., 100MHz ≤ f ≤ 3GHz)	-127 ≤ p < -120
	Output level [p](dBm)																	
±3.0dB (typ., 100kHz ≤ f < 250kHz)	-110 ≤ p ≤ -3																	
±1.0dB (typ., 250kHz ≤ f ≤ 25MHz)	-110 ≤ p ≤ -3																	
±1.0dB (typ., 25MHz < f < 100MHz)	-110 ≤ p ≤ +4																	
±0.5dB (typ., 100MHz ≤ f < 375MHz)	-110 ≤ p ≤ +4																	
±0.5dB (375MHz ≤ f ≤ 3GHz)	-110 ≤ p ≤ +4																	
±1.0dB (100MHz ≤ f ≤ 3GHz)	-120 ≤ p < -110																	
±1.0dB (typ., 100MHz ≤ f ≤ 3GHz)	-127 ≤ p < -120																	
Arbitrary Signal Generator	Available when the MS2830A/MS2840A-020, 021 or 189 (Vector Signal Generator) is installed.																	

# Audio Analyzer Option Specifications (1/3)

Audio Analyzer Option		MS2830A-018/118
<b>Audio Analyzer Function</b>		Specifications for single tone measurement
Connection Type		Balanced: Standard phone jack (3-pole, $\Phi$ 6.3 mm) Unbalanced: BNC-J
Input Impedance		Balanced: 200 k $\Omega$ (AC coupled, nominal) Unbalanced: 100 k $\Omega$ (AC coupled, nominal)
Frequency Measurement Range		20 Hz to 50 kHz
Level Measurement Range		1 mV rms to 25 V rms (30 V rms, max)
Input Range Setting		50 mV peak, 500 mV peak, 5V peak, 50V peak
Level Accuracy		$\pm 0.4$ dB (20 Hz $\leq$ f $\leq$ 25 kHz) $\pm 3.0$ dB (25 kHz < f $\leq$ 50 kHz) (18° to 28°C)
THD + N (Total Harmonic Distortion + Noise)		At 1 kHz, 1.4 V rms, 20 Hz to 20 kHz band, 5 Vp-p range, 18° to 28°C: < -60 dB < -80 dB (nominal)
Audio Filter	LPF	Off, 3, 15, 20, 30, 50 kHz
	HPF	Off, 20, 50, 100, 300, 400 Hz, 30 kHz
Weighting Filter		Off, CCITT, C-Message, CCIR468, CCIR-ARM, A-Weighting

# Audio Analyzer Option Specifications (2/3)

Audio Analyzer Option		MS2830A-018/118	
<b>Audio Generator Function</b>		Specifications for all single-tone measurements except White Noise (through ITU-T Rec. G.227 filter)	
Connection Type	Balanced: Standard phone jack (3-pole, $\Phi 6.3$ mm) Unbalanced: BNC-J		
Interface	Balanced: $100\Omega/600\Omega$ (AC coupled, nominal) Unbalanced: $50\Omega/600\Omega$ (AC coupled, nominal)		
Output Waveform	Single tone, multi-tone (Tone $\times$ 3, DCS, White Noise (through ITU-T Rec. G.227 filter), DTMF)		
Guaranteed Frequency Range	20 Hz to 25 kHz		
Frequency Setting Range	10 Hz to 50 kHz		
Frequency Resolution	0.01 Hz		
Output Level Range <sup>*1</sup>	Using Sub Supply/Audio Revision 2 <sup>*2</sup> (all units shipped from March 26, 2015)		
	Single tone		
	Open circuit voltage ( $\geq 100$ k $\Omega$ Termination)	Balanced	off, 1 mV rms to 12.4 V rms
		Unbalanced	off, 1 mV rms to 6.2 V rms
	600 $\Omega$ Termination <sup>*2</sup>	Balanced	off, -63 dBm (equivalent to 0.5 mV rms) to +18 dBm (equivalent to 6.2 V rms)
		Unbalanced	off, -63 dBm (equivalent to 0.5m V rms) to +12 dBm (equivalent to 3.1 V rms)
	White Noise (through ITU-T G.227 filter)		
	Open circuit voltage ( $\geq 100$ k $\Omega$ Termination)	Balanced	off, 1.545 mV rms to 3.083 V rms (nominal)
		Unbalanced	off, 1.545 mV rms to 1.545 V rms (nominal)
	600 $\Omega$ Termination <sup>*2</sup>	Balanced	off, -60 dBm (equivalent to 0.774 mV rms) to +6 dBm (equivalent to 1.545 V rms) (nominal)
		Unbalanced	off, -60 dBm (equivalent to 0.774 mV rms) to 0 dBm (equivalent to 0.774 V rms) (nominal)

\*1: Output Impedance = 600 $\Omega$  , and Output Impedance Reference = 600 $\Omega$

Refer to the 'Interface Setting Example (Audio Analyzer)' slides for the voltage and power calculations.

# Audio Analyzer Option Specifications (3/3)

Audio Analyzer Option		MS2830A-018/118
<b>Audio Generator Function</b>		Standard for all single-tone measurements except White Noise (through ITU-T Rec. G.227 filter)
Output Level Resolution		Single Tone: 1 mV (350 mV rms < Output Level ≤ 6.2 V rms) 100 μV (35 mV rms < Output Level ≤ 350 mV rms) 10 μV (Output Level ≤ 35 mV rms) White Noise (through ITU-T Rec. G.227 filter): 0.01dB
Level Accuracy		Single Tone ±0.3 dB (1 kHz, 100 kΩ termination, 18° to 28°C) White Noise (through ITU-T Rec. G.227 filter): ±3 dB (nominal)
Maximum Output Current		100 mA (nominal, no short circuit)
THD + N (Total Harmonic Distortion + Noise)		At 1 kHz, 0.7 Vrms, 20 Hz to 25 kHz band, 100kΩ termination, 18° to 28°C: <-60 dB <-80 dB (nominal)
Weighting Filter (White Noise)		ITU-T Recommendation G.227
<b>Other Function</b>		
Demodulation Output (FM only)	Demodulation Output Level	-10 dBm ±2 dB (Frequency Deviation = 3.5 kHz, 600Ω)
	Demodulation Output Impedance	600Ω
	Sound Monitor	Internal speaker or 3.5 mm phone jack (2-pole, monaural)
Crosstalk		Crosstalk from Audio Generator to Audio Analyzer >80 dB
PTT (Push To Talk) Control		Banana jack (Φ4.0 mm, 30 V max, 500 mA max.)
General Input/Output (Audio Function)		Connector: D-Sub 15pin (jack) Function: Open Collector × 1(5 V, 100 mA max.), TTL Output: × 2, TTL Input × 2

\*2: Sub Supply/Audio Revision is the MS2830A-018/118 printed-circuit board version.

<Sub Supply/Audio Revision Confirmation Method>

(1) MS2830A units with Sub Supply/Audio Revision 2 have a sticker marked 'A1' next to the main-frame serial number.

(2) The MS2830A Sub Supply/Audio Revision can be confirmed as follows:

Press [System Config] → [F5] System Information → [F4] Board Revision View to list the Board Revisions; check the displayed Sub Supply/Audio Revision number. (It may be either 1 or 2.)

# Section 4

**MS2830A**

- **Ordering Information**

**Option Addition**

**MS2830A**

- **Internal Signal Generator Control Function**

**Application parts**

- **USB Power Sensor**

**MS2840A**

- **Ordering Information**

# MS2830A Ordering Information (1/2)

MS2830A

	Name	Model		Note
		New	Retrofit*3	
Mandatory	3.6 GHz Signal Analyzer	MS2830A-040	-	9 kHz to 3.6 GHz, Cannot retrofit.
	6 GHz Signal Analyzer	MS2830A-041	-	9 kHz to 6 GHz, Cannot retrofit.
	13.5 GHz Signal Analyzer	MS2830A-043	-	9 kHz to 13.5 GHz, Cannot retrofit. Cannot be installed MS2830A-066 and signal generator options simultaneously
Mandatory	Low Phase Noise Performance	MS2830A-066	-	Improved phase noise performance Cannot retrofit.
Mandatory	Analog Measurement Software	MX269018A*1		Frequency setting range: At FM/ΦM/AM measurement : 100 kHz to the upper limit of the main unit At Wide Band FM measurement: 10 MHz to the upper limit of the main unit
Mandatory	USB Audio	A0086D		Necessary for demodulated sound output
Recommend	High Stability Reference Oscillator	MS2830A-002	MS2830A-102	Aging Rate: $\pm 1 \times 10^{-7}$ /year Start-up Characteristics: $\pm 5 \times 10^{-8}$ (5 minutes after power-on)
	3.6GHz Analog Signal Generator	MS2830A-088	MS2830A-188*1	Frequency setting range (FM, ΦM, AM ): 100 kHz to 3 GHz, Cannot be installed with MS2830A-043. (Require MX269018A, A0086D)
	Audio Analyzer	MS2830A-018	MS2830A-118*1	
	Vector Function Extension for Analog Signal Generator	-	MS2830A-189	Add vector function to MS2830A-088/188
	3.6 GHz Vector Signal Generator	MS2830A-020	MS2830A-120	250 kHz to 3.6 GHz
	6 GHz Vector Signal Generator	MS2830A-021	MS2830A-121	250 kHz to 6 GHz
	Low Power Extension for Vector Signal Generator	MS2830A-022	MS2830A-122	Extends lower output level limit. Mandatory to MS2830A-029
	Analog Function Extension for Vector Signal Generator	MS2830A-029	*2	Add analog function to MS2830A-020/120/021/121 (Require MS2840A-022/122, MX269018A, A0086D)
	Internal Signal Generator Control Function	MS2830A-052	MS2830A-152	Functions equivalent to tracking generator

\*1: MS2830A-188/118 Retrofit conditions

- ✓ Requires previous installation of either MS2830A-066 or MS2830A-062 in MS2830A main frame
- ✓ Requires MX269018A and A0086D sold separately
- ✓ MS2830A-188 cannot be retrofitted to 13.5 GHz model (MS2830A-043)

\*2: Please contact our sales representative when requiring the MS2830A-029 retrofit.

\*3: Installation Kit Z1345A is required.

## Optional combination necessary for mounting analog signal generator

Option model are decided by the MS2830A which required analog signal generator (SG).

Please note that there is a case where an analog SG function cannot be installed for a part of MS2830A composition.

MS2830A installed analog SG		New MS2830A	The case that retrofit analog SG to MS2830A		
Frequency option of MS2830A		↓	MS2830A-040/041 (3.6GHz/6GHz models with MS2830A-066 or 062)		MS2830A-043 (13.5GHz model)
Installed vector SG		↓	Not installed	MS2830A-020/021	↓
SG & mandatory option that can be added	Analog SG	MS2830A-088 + MS2830A-066 + MX269018A + A0086D	MS2830A-188 + MX269018A*3 + A0086D*3 + Z1345A	*1	Cannot be installed
	Analog SG + Vector SG	MS2830A-020/021 + MS2830A-022 + MS2830A-029 + MS2830A-066 + MX269018A + A0086D	MS2830A-188*2 + MS2830A-189*2 + MX269018A*3 + A0086D*3 + Z1345A	-	

\*1: Please contact our sales representative.

\*2: Can select only 3.6 GHz Vector SG/Analog SG

\*3: Unnecessary MX269018A and A0086D already installed

With 3.6 GHz Signal Analyzer (MS2840A-040) or 6 GHz Signal Analyzer (MS2840A-041)

	Name	Model		Note
		New	Retrofit *1	
Mandatory	3.6 GHz Signal Analyzer	MS2840A-040	-	9 kHz to 3.6 GHz, Cannot retrofit.
	6 GHz Signal Analyzer	MS2840A-041	-	9 kHz to 6 GHz, Cannot retrofit.
Mandatory	Analog Measurement Software	MX269018A		Frequency setting range: At FM/ΦM/AM measurement: 100 kHz to the upper limit of the main unit At Wide Band FM measurement: 10 MHz to the upper limit of the main unit
Mandatory	USB Audio	A0086D		Necessary for demodulated sound output
Recommend	Low Phase Noise Performance	MS2840A-066	MS2840A-166	Improves phase noise performance. This option greatly improves SSB phase noise performance.
	High Stability Reference Oscillator	MS2840A-002	MS2840A-102	Aging Rate: $\pm 1 \times 10^{-7}$ /year Start-up Characteristics: $\pm 5 \times 10^{-8}$ (5 minutes after power-on)
	3.6GHz Analog Signal Generator	MS2840A-088	MS2840A-188	Frequency setting range (FM, ΦM, AM ): 100 kHz to 3 GHz (Require MX269018A, A0086D)
	Vector Function Extension for Analog Signal Generator	-	MS2840A-189	Add vector function to MS2840A-088/188
	3.6 GHz Vector Signal Generator	MS2840A-020	MS2840A-120	250 kHz to 3.6 GHz
	6 GHz Vector Signal Generator	MS2840A-021	MS2840A-121	250 kHz to 6 GHz
	Low Power Extension for Vector Signal Generator	MS2840A-022	MS2840A-122	Extends lower output level limit Mandatory for MS2840A-029/129
	Analog Function Extension for Vector Signal Generator	MS2840A-029	MS2840A-129	Add analog function to MS2840A-020/120/021/121 (Require MS2840A-022/122, MX269018A, A0086D)

\*1: Require Installation Kit Z1932A

With 26.5 GHz Signal Analyzer (MS2840A-044) or 44.5 GHz Signal Analyzer (MS2840A-046)

	Name	Model		Note
		New	Retrofit *1	
Mandatory	26.5 GHz Signal Analyzer	MS2840A-044	-	9 kHz to 26.5 GHz, Cannot retrofit.
	44.5 GHz Signal Analyzer	MS2840A-046	-	9 kHz to 44.5 GHz, Cannot retrofit.
Mandatory	Analog Measurement Software	MX269018A		Frequency setting range: At FM/ΦM/AM measurement: 100 kHz to the upper limit of the main unit At Wide Band FM measurement: 10 MHz to the upper limit of the main unit
Mandatory	USB Audio	A0086D		Necessary for demodulated sound output

\*1: Require Installation Kit Z1932A

## Optional combination necessary for mounting analog signal generator

Option model are decided by the MS2840A which required analog signal generator (SG).

Please note that there is a case where an analog SG function cannot be installed for a part of MS2840A composition.

MS2840A installed analog SG		New MS2840A	The case that retrofit analog SG to MS2840A	
Frequency option of MS2840A		↓	MS2840A-040/041 (3.6GHz/6GHz model)	
Installed vector SG		↓	Not installed	MS2840A-020/021
SG & Mandatory options that can be added	Analog SG	MS2840A-088 + MX269018A + A0086D	MS2830A-188 + MX269018A*2 + A0086D*2 + Z1932A	MS2840A-129 + MS2840A-122*2 + MX269018A*2 + A0086D*2 + Z1932A
	Analog SG + Vector SG	MS2840A-020/021 + MS2840A-022 + MS2840A-029 + MX269018A + A0086D	MS2840A-188*1 + MS2840A-189*1 + MX269018A*2 + A0086D*2 + Z1932A	-

\*1: Can select only 3.6 GHz Vector SG/Analog SG

\*2: Unnecessary when MS2840A-022, MX269018A and A0086D already installed

Adding the Internal Signal Generator Control Function MS2830A-052 to the MS2830A with installed Analog Signal Generator supports the spectrum analyzer (SPA) and signal generator (SG) tracking function for measuring transmission characteristics of filters, amplifiers, etc.

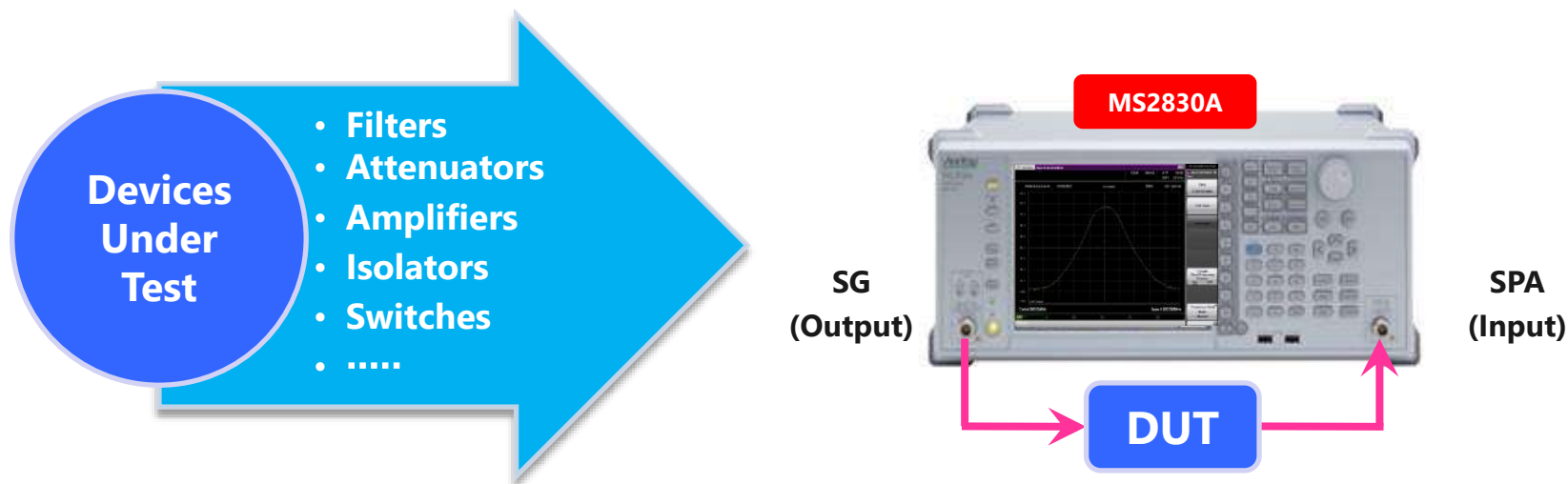

## ✓ Measure Both Passive and Active Devices

The DUT input signal source has a frequency range of 100 kHz to 3.6 GHz or 6 GHz\*, an output level range of -136 dBm to +15 dBm, a step resolution of 0.01 dB, and a level accuracy of  $\pm 0.5$  dB to measure both passive and active devices using the built-in high-performance SG.

## ✓ Accurate Frequency Characteristics

The SPA function displays the measured frequency characteristics results with an excellent linearity error of just  $\pm 0.07$  dB to display the frequency characteristics of band-pass filters, etc., accurately.

\*Changes according to option for SG

## ■USB Power Sensor

Power measurement is available with USB Power Sensor connected to MS2830A and MS2840A.

Model	Name	Note
MA24105A	Inline Peak Power Sensor	Corresponding to the measurement of continuous wave Frequency: 350 MHz to 4 GHz, Dynamic Range: +3 to +51.76 dBm
MA24106A	USB Power Sensor	Corresponding to the measurement of continuous wave Frequency: 50 MHz to 6 GHz, Dynamic Range: -40 to +23 dBm
MA24108A	Microwave USB Power Sensor	Corresponding to the measurement of continuous wave and burst wave Frequency: 10 MHz to 8 GHz, Dynamic Range: -40 to +20 dBm
MA24118A	Microwave USB Power Sensor	Corresponding to the measurement of continuous wave and burst wave Frequency: 10 MHz to 18 GHz, Dynamic Range: -40 to +20 dBm
MA24126A	Microwave USB Power Sensor	Corresponding to the measurement of continuous wave and burst wave Frequency: 10 MHz to 26 GHz, Dynamic Range: -40 to +20 dBm

[Power meter application main screen]



Power [dBm]

Relative Power [dB]

Power [W]



**Anritsu**  
Advancing beyond