

# U2000 Series USB Power Sensors

The compact, low-cost alternative to conventional power measurement solutions

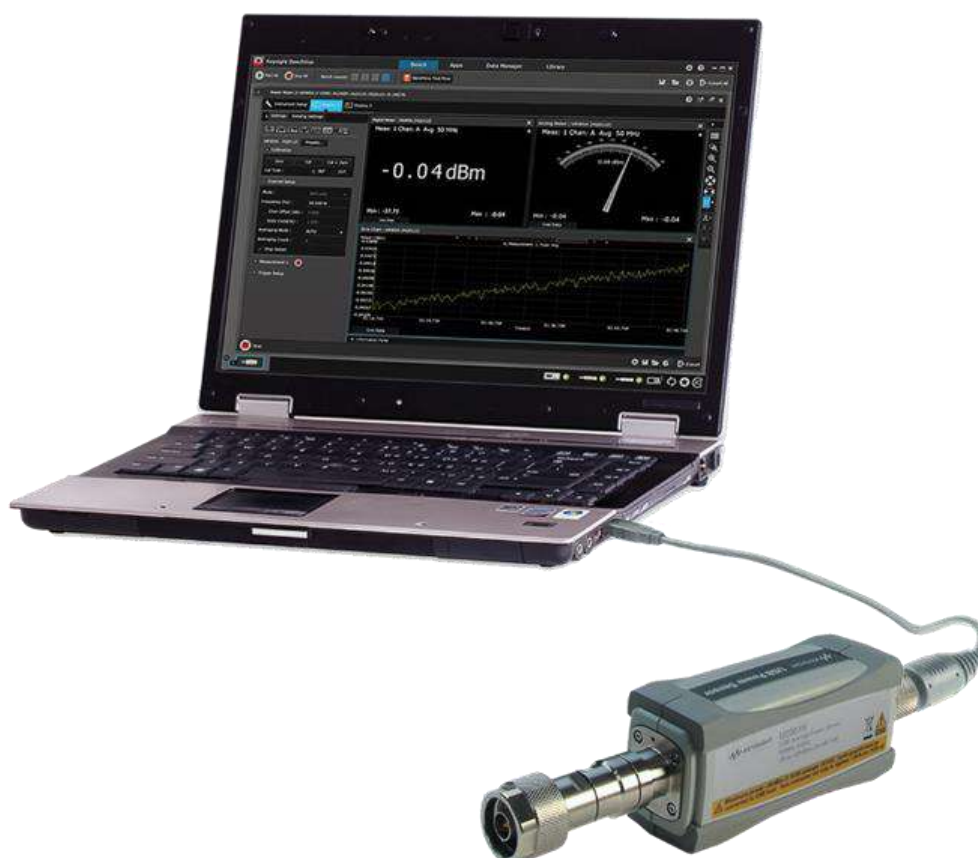

# Table of Contents

Why Keysight’s Power Meters and Sensors? ..... 3

Compact Solutions for Testing Today’s RF and Microwave Communication Systems ..... 4

Introducing the U2000 Series USB Power Sensors ..... 5

Take a Closer Look..... 8

Specifications..... 9

Using the U2000 Series with the BenchVue Software ..... 26

System and Installation Requirements..... 27

Ordering Information ..... 28

# Why Keysight's Power Meters and Sensors?

## Reliable, high-performing solutions

Every power meter and sensor from Keysight Technologies, Inc. consistently delivers great results.

## A sure investment for many years to come

Code-compatibility between power meters reduces the need for re-coding. Not only that, all Keysight power meters are backward-compatible with most legacy power sensors.

## One specific application: One right solution

Keysight offers a wide selection of power meters and sensors for practically all application needs—wireless communications, radar pulse measurements, component test, and more.

## Global network support

No matter where you are, Keysight is committed to giving you the 24-hour support you need regarding our products, applications, or services.

Keysight's power meters have long been recognized as the industry standard for RF and microwave power measurements.

# Compact Solutions for Testing Today's RF and Microwave Communication Systems

## For installation and maintenance of base stations

- Lightweight and rugged
- Simple set-up and usage
- Portable with low power consumption
- Wide dynamic and frequency ranges
- Quick and easy testing with large display of readings
- Internal trigger eliminates the problem for applications that do not have external trigger signal
- Trace display capability enables easy gate setup

## For production testing of wireless components

- Compact build saves rack space
- Simple set-up and usage
- Wide dynamic and frequency ranges
- Fast reading speed
- Internal zeroing reduces test time and sensor wear-and-tear
- Quick and easy multiple channels testing with simultaneous display of readings, limits and alerts
- Seamless integration to system with industry standard SCPI
- Internal trigger eliminates the problem for tests that do not have external trigger signal
- Trace display capability enables easy trigger level and gate setup

## For R&D of wireless components

- Compact build saves bench space
- Simple set-up and usage
- Wide dynamic and frequency ranges
- High accuracy
- Advanced troubleshooting of designs with simultaneous display of multiple readings, measurement math and data recording
- Internal trigger eliminates the problem for applications that do not have external trigger signal

# Introducing the U2000 Series USB Power Sensors

The U2000 Series enable simpler, lower-cost power measurements versus conventional power meter and sensor combinations. Now with nine high-performance models, the U2000 Series USB power sensors offer compact, high-performance solutions for today's CW and modulated signals.



## Features

- Compact, lightweight solutions
- Quick, simple set-up
- High accuracy, high power
- Internal zeroing capability
- Fast reading speed
- Wide frequency range:
- 9 kHz to 24 GHz (sensor option dependent)
- Wide dynamic range:
- -60 to +44 dBm
- Support internal and external trigger measurements <sup>1</sup>
- Trace display capability enables easy trigger level and gate setup for burst signals
- Allows remote measurements beyond cable length
- Enables monitoring of more than 20 channels simultaneously
- Converts select Keysight instruments to power meters
- Feature-packed software provides various capabilities for easy testing and analysis
- Average power measurements of CW and modulated signals, including GSM, EDGE, WLAN and WiMAX™

---

<sup>1</sup> Except U2004A model

## Compact “power meters”, simple set-up

The U2000 Series are standalone sensors. That means they essentially operate like power meters, just in smaller forms. No reference calibrator is required. The fact that each sensor draws minimal power from a USB port — and that it doesn’t need additional triggering modules or power adaptors to operate — makes it more portable, especially for base station testing. Setting up is easy: just plug it to the USB port of your PC or laptop — or even select network or handheld spectrum analyzer — and start your power measurements. The figure below illustrates the very simple, straightforward setup of the U2000 Series.

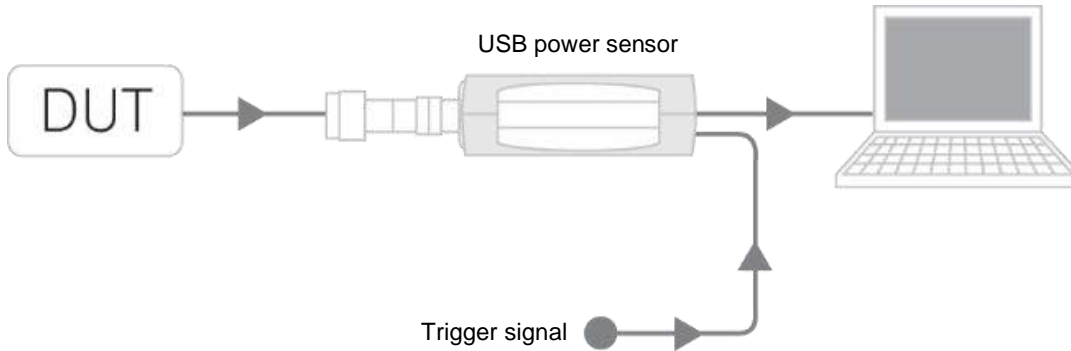

## High accuracy

Each U2000 Series sensor provides excellent linearity, SWR and uncertainty specifications, so you can be confident in every measurement you make.

## Wide range, high power

The U2000 Series’ dynamic range spans across a wide 80 dB, taking on high power up to +44 dBm.

## Remote monitoring and tests

With the U2000 Series sensor plugged to a networked USB hub, you can conveniently monitor power measurements of an antenna tower from the control room, beyond the limits of USB cable lengths.

## Faster production testing of multiple channels

The U2000 Series’ fast measurement speed helps reduce test time. This, coupled with the capability to enable monitoring of more than 20 channels simultaneously, is an advantage in the production line where efficiency is of utmost priority.

The U2000 Series has both internal and external zeroing capabilities. With internal zeroing, high isolation switches in the sensor are opened to isolate the sensor from the device-under-test (DUT) it is connected to. As such, you don't need to power-off the DUT or disconnect the sensors. This speeds up testing and reduces sensor wear-and-tear.

No manual input of calibration data is required. All calibration factors, as well as temperature and linearity corrections, are stored in the sensors' EEPROM, auto-downloaded at calibration.

Often, you'd need to automate your tests. The U2000 Series sensors are well-equipped for seamless integration to your system with industry standard SCPI compatibility. They also come with built-in triggering capability to allow receipt of external triggers from other instruments.

## Transform your signal generators and spectrum analyzers into accurate power meters

You could literally have a power meter next to you — or instead, turn your Keysight signal generators, handheld spectrum analyzers or FieldFox handheld RF/Microwave analyzers into a power meter for accurate power measurements. Even with the U2000 connected, you can switch between power measurements and the device's original function at any time. You can also use the U2000 with your Keysight network analyzers for source power calibration.



## Intuitive power analysis software

The U2000 Series is supported by the Keysight BenchVue software and BV0007B Power Meter/Sensor Control and Analysis app. Once you plug the USB power sensor into a PC and run the software you can see measurement results in a wide array of display formats and log data without any programming.

For more information, [www.keysight.com/find/BenchVue](http://www.keysight.com/find/BenchVue)

# Take a Closer Look

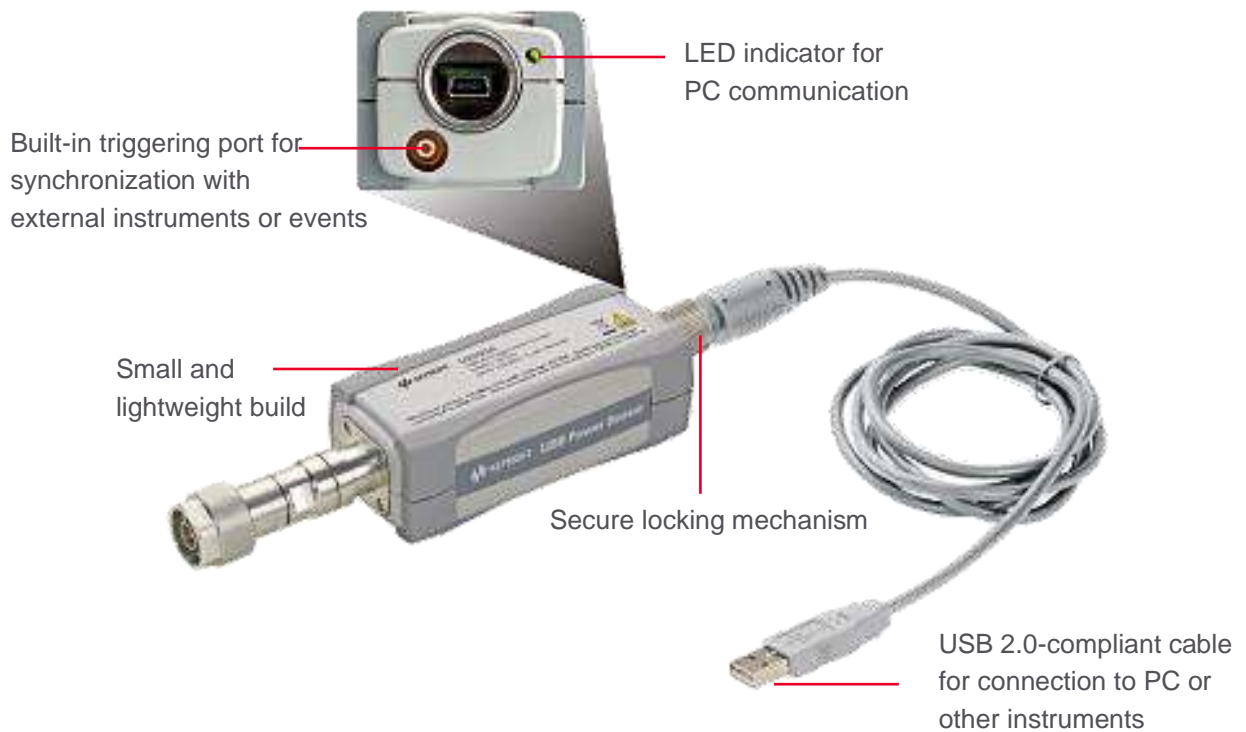

Diode-based sensors frequently rely on the application of correction factors to extend their dynamic range beyond their square-law region, typically in the range of  $-70$  to  $-20$  dBm. While this technique achieves measurement of CW signals over a wide dynamic range, it fails to do so for modulated signals when the signal level is above the square-law region. Modulated signals must be padded down, with their average and peak power levels within the diode square-law region, for accurate average power measurement.

The U2000 Series USB power sensors are true-average, wide-dynamic-range RF/ microwave power sensors, based on a dual-sensor diode pair/attenuator/diode pair topology as proposed by Szente et. al. in 1990.<sup>2</sup>

<sup>2</sup> US Patent #4943764 assigned to Hewlett-Packard Company

The simplified block diagram shown here illustrates this technique.

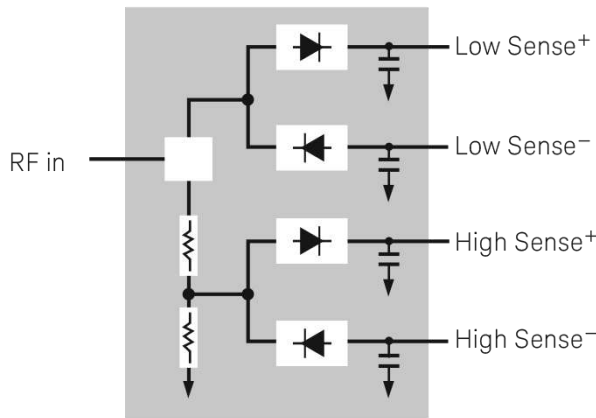

This technique ensures diodes in the selected signal path are kept in their square law region — with output current and voltage proportional to input power. The diode pair/attenuator/diode pair assembly can then yield the average of complex modulation formats across a wide dynamic range, irrespective of signal bandwidth.

The dual range Modified Barrier Integrated Diode (MBID)<sup>3</sup> package incorporates diode stacks in place of single diodes. This further improves measurement accuracy of high-level signals with high crest factors without incurring damage<sup>4</sup> to the sensor.

Implementation of both techniques in the U2000 Series USB sensors enable effective average power measurements of a wide range of signals, including multitone and spread spectrum signals used in CDMA, W-CDMA and digital television systems.

## Specifications

Specifications contained in this chapter are valid ONLY after proper calibration of the power sensor and apply to continuous wave (CW) signals unless otherwise stated. The recommended calibration interval for this product is one year.

Specifications apply over a temperature range 0 to +55 °C unless otherwise stated. Specifications quoted over a temperature range of 25 °C ± 10 °C apply to a relative humidity of 15% to 75% and conform to the standard environmental test conditions. Specifications are valid after a 30-minute warm-up period.

Supplemental characteristics, shown in italics, are intended to provide useful information with regard to applying the power sensors in that they contain typical, but non-warranted performance parameters. These characteristics are shown in italics or denoted as “typical”, “nominal” or “approximate”.

<sup>3</sup> November 1986 Hewlett-Packard Journal pages 14-2, “Diode Integrated Circuits for Millimeter-Wave Applications”.

<sup>4</sup> Refer to “Maximum Power” on page 9 for maximum power handling specifications.

## Measurement speed

**Normal:** 20 readings/s

**x2:** 40 readings/s

**Fast:** 110 readings/s

**Buffered (50 readings):** 1000 readings/s<sup>5</sup>

The U2000 Series USB sensors have two measurement modes:

**Average only mode (default mode):** Optimized for wide dynamic range. In this measurement mode, a trigger can be controlled externally via TTL input.

**Normal<sup>6</sup> mode:** Used for making average power measurement in a defined time interval (time-gated measurement) with reduced dynamic range. A trigger can be derived from an RF signal (internal trigger) or controlled externally via TTL input (external trigger).

## Frequency and power ranges

Model	Frequency range	Power range	Maximum power
U2000A	10 MHz to 18 GHz	-60 to +20 dBm	+25 dBm avg, 20 VDC
U2001A	10 MHz to 6 GHz		+33 dBm pk, < 10 $\mu$ s
U2002A	50 MHz to 24 GHz		
U2004A	9 kHz to 6 GHz	-60 to +20 dBm	+25 dBm avg, 5 VDC +33 dBm pk, < 10 $\mu$ s
U2000B	10 MHz to 18 GHz	-30 to +44 dBm	+45 dBm avg, 20 VDC
U2001B	10 MHz to 6 GHz		+47 dBm pk, 1 $\mu$ s
U2000H	10 MHz to 18 GHz	-50 to +30 dBm	+33 dBm avg, 20 VDC
U2001H	10 MHz to 6 GHz		+50 dBm pk, 1 $\mu$ s
U2002H	50 MHz to 24 GHz	-50 to +30 dBm	+33 dBm avg, 10 VDC +50 dBm pk, 1 $\mu$ s

<sup>5</sup> The 1000 reading/s is the derived measurement speed from the first 50 readings in buffered mode. The maximum number of measurements that can be obtained in one second is 250 readings in buffered mode.

<sup>6</sup> Not applicable for U2004A.

## Maximum SWR

Model	Frequency range	Maximum SWR (25 °C ± 10 °C)	Maximum SWR (0 °C to 55 °C)
U2000A	10 to 30 MHz	1.15	1.21
	> 30 MHz to < 2 GHz	1.13	1.15
	2 to < 14 GHz	1.19	1.20
	14 to < 16 GHz	1.22	1.23
	16 to 18 GHz	1.26	1.27
U2001A	10 to 30 MHz	1.15	1.21
	> 30 MHz to < 2 GHz	1.13	1.15
	2 to 6 GHz	1.19	1.20
U2002A	50 MHz to 2 GHz	1.13	1.15
	> 2 to 14 GHz	1.19	1.20
	> 14 to 16 GHz	1.22	1.23
	> 16 to 18 GHz	1.26	1.27
	> 18 to 24 GHz	1.30	1.30
U2004A	9 kHz to 2 GHz	1.13	1.15
	> 2 to 6 GHz	1.19	1.20
U2000B	10 MHz to 2 GHz	1.12	1.14
	> 2 to < 12.4 GHz	1.17	1.18
	12.4 to 18 GHz	1.24	1.25
U2001B	10 MHz to 2 GHz	1.12	1.14
	> 2 to 6 GHz	1.17	1.18
U2000H	10 MHz to < 8 GHz	1.15	1.17
	8 to < 12.4 GHz	1.25	1.26
	12.4 to 18 GHz	1.28	1.29
U2001H	10 MHz to 6 GHz	1.15	1.17
U2002H	50 MHz to < 8 GHz	1.15	1.17
	8 to < 12.4 GHz	1.25	1.26
	12.4 to 18 GHz	1.28	1.29
	> 18 to 24 GHz	1.30	1.31

### Typical SWR for U2000A sensor (25 °C ± 10 °C)

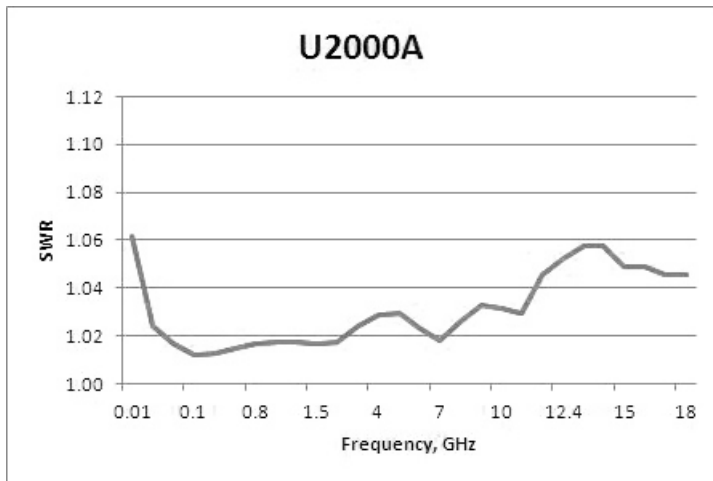

### Typical SWR for U2001A sensor (25 °C ± 10 °C)

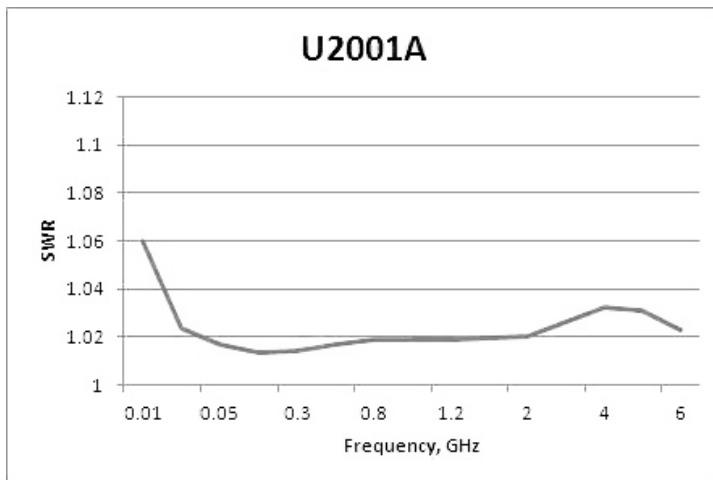

### Typical SWR for U2002A sensor (25 °C ± 10 °C)

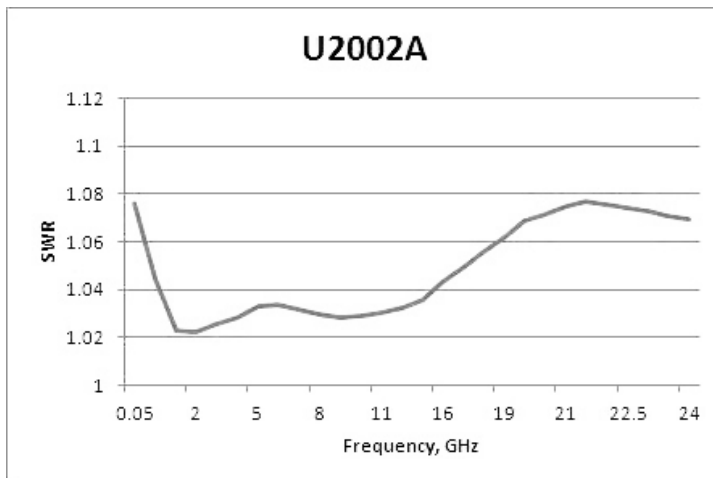

### Typical SWR for U2004A sensor (25 °C ± 10 °C)

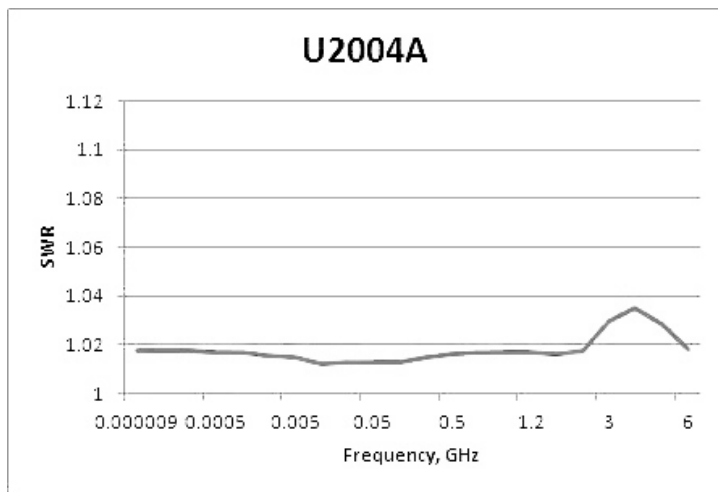

### Typical SWR for U2002H sensor (25 °C ± 10 °C)

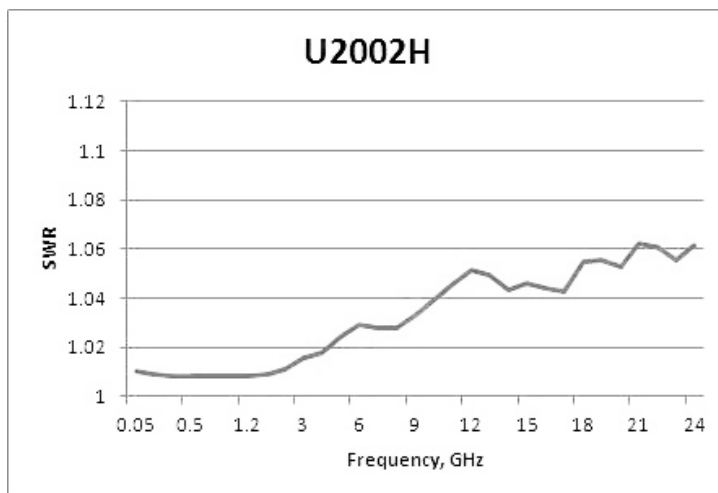

### Typical SWR for U2000H sensor (25 °C ± 10 °C)

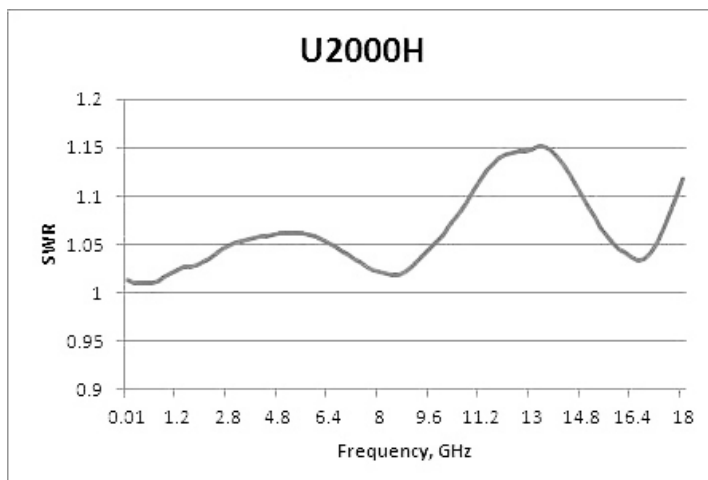

### Typical SWR for U2000B sensor (25 °C ± 10 °C)

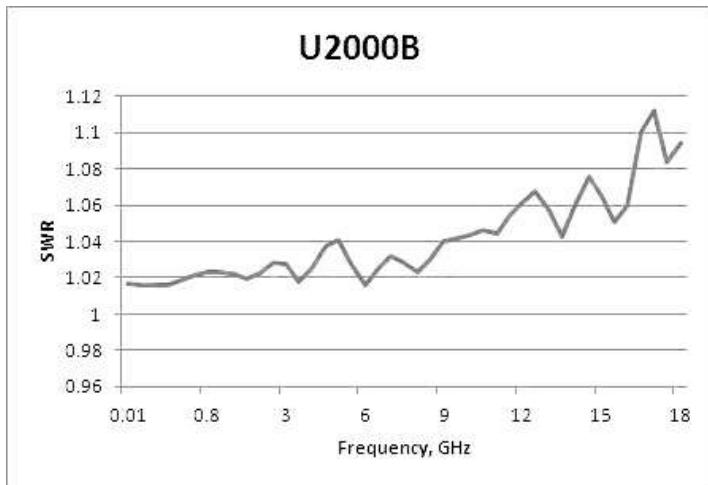

### Typical SWR for U2001H sensor (25 °C ± 10 °C)

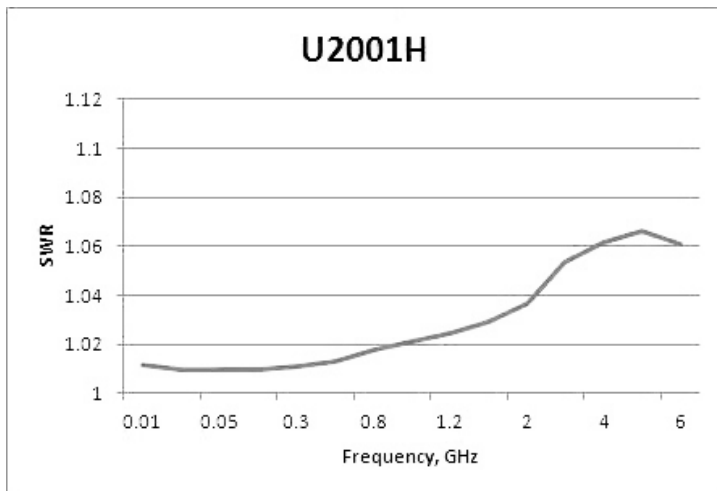

### Typical SWR for U2001B sensor (25 °C ± 10 °C)

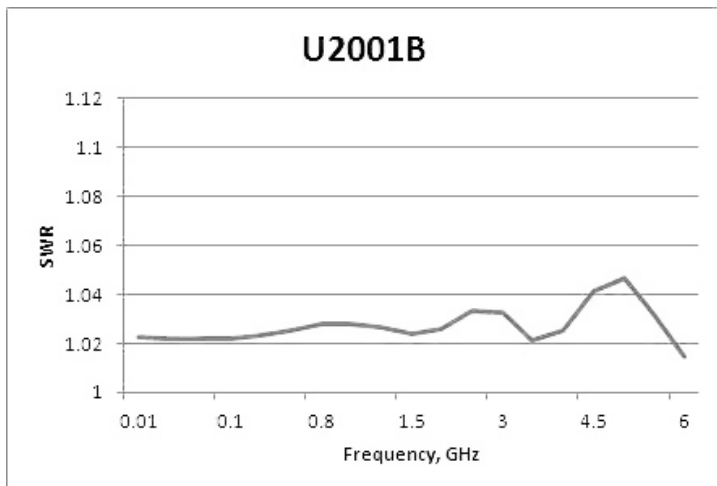

## Switching point

The U2000 Series power sensors have two measurement paths: a low-power path and a high-power path, as shown in the table below.

Models	AUTO (default) range	Low power path	High power path	Switching point
U2000/1/2/4A	–60 to +20 dBm	–60 to –7 dBm	–7 to +20 dBm	–7 dBm
U2000/1/2H	–50 to +30 dBm	–50 to +3 dBm	+3 to +30 dBm	+3 dBm
U2000/1B	–30 to +44 dBm	–30 to +23 dBm	+23 to +44 dBm	+23 dBm

Each power sensor automatically selects the proper power level path. To avoid unnecessary switching when the power level is close to the switching point, switching point hysteresis has been added.

**Offset at switching point:**  $\leq \pm 0.5\%$  ( $\leq \pm 0.02$  dB) typical

**Switching point hysteresis:**  $\pm 0.5$  dBm typical

**Example with U2000 “A” suffix sensors:** Switching point for the U2000/1/2/4A sensors is at –7 dBm. Hysteresis causes the low power path to remain selected until approximately –6.5 dBm as the power level is increased. Above this power, the high-power path is selected. The high-power path remains selected until approximately –7.5 dBm is reached as the signal level decreases. Below this power, the low power path is selected.

## Power accuracy

Average only mode power accuracy<sup>7</sup> (with exclusions).

Model	Power range	Accuracy <sup>1</sup> (25 °C $\pm$ 10 °C)	Accuracy <sup>1</sup> (0 °C to 55 °C)
U2000/1/2/4A	–60 to +20 dBm	$\pm 3.0\%$	$\pm 3.5\%$
U2000/1/2H	–50 to +30 dBm	$\pm 4.0\%$	$\pm 5.0\%$
U2000/1B	–30 to +44 dBm	$\pm 3.5\%$	$\pm 4.0\%$

Specifications valid with the following conditions:

- After zeroing<sup>8</sup>
- Number of averages = 1024
- After 30 minutes of power-on warm-up

<sup>7</sup> This accuracy is essentially a combination of linearity, instrumentation accuracy, and traceability to absolute accuracy at 50 MHz, 0 dBm. Note: Mismatch uncertainty, calibration factor uncertainty, and power level dependent terms (zero set, drift, and noise) are excluded in this specification and specified elsewhere in the data sheet.

<sup>8</sup> It is advisable to perform external zeroing on the U2000 Series power sensor for power measurement level below –30 dBm. During the external zeroing process, the RF input signal must be switched off or the device-under-test disconnected from the U2000 Series power sensor.

Normal mode power accuracy<sup>9, 10</sup>, (with exclusions).

Model	Power range	Accuracy (25 °C ± 10 °C)
U2000/1/2/A	-30 to +20 dBm	± 4.0%
U2000/1/2H	-20 to +30 dBm	± 5.0%
U2000/1B	0 to +44 dBm	± 4.5%

### Typical power accuracy at 25 °C for U2000/1/2/4A sensors<sup>11, 12</sup>

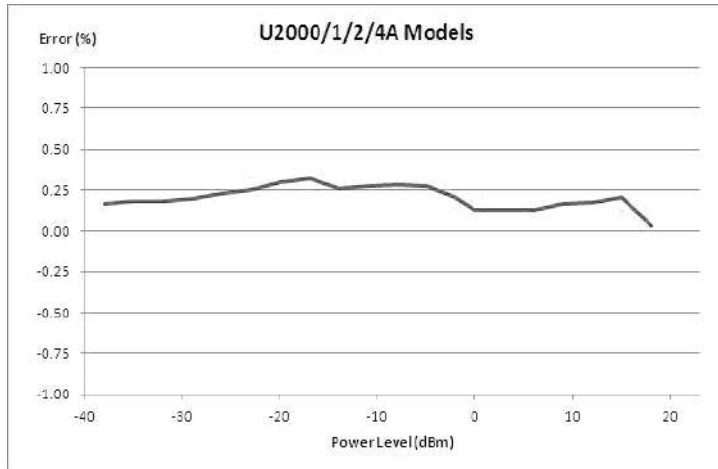

### Typical power accuracy at 25 °C for U2000/1B sensors<sup>11, 12</sup>

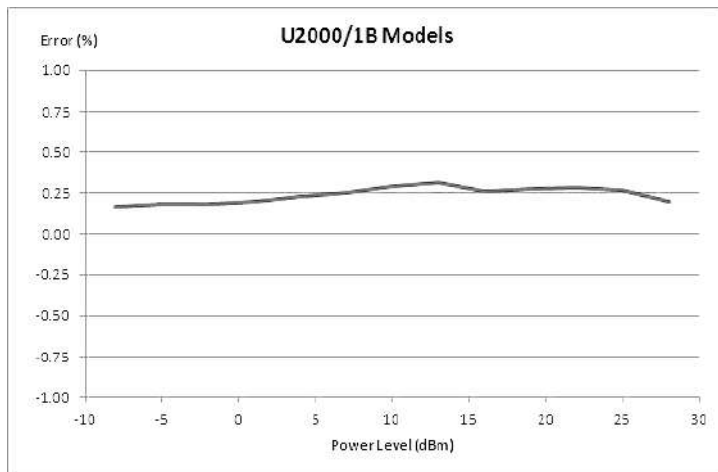

<sup>9</sup> This accuracy is essentially a combination of linearity, instrumentation accuracy, and traceability to absolute accuracy at 50 MHz, 0 dBm. Note: Mismatch uncertainty, calibration factor uncertainty, and power level dependent terms (zero set, drift, and noise) are excluded in this specification and specified elsewhere in the data sheet.

<sup>10</sup> The accuracy for -7 to +1 dBm (U2000/1/2A), +3 to +11 dBm (U2000/1/2H), and +23 to +31 dBm (U2000/1B) power level will be dominated by zero set and measurement noise. For overall accuracy, refer to the measurement uncertainty calculator which is available on the Keysight Technologies Web site.

<sup>11</sup> Measurement uncertainty ≤ 1.9%. At room temperature and excluding power level dependent terms (zero set, drift, and noise). Refer to Keysight Fundamentals of RF and Microwave Power Measurements (Part 3) Power Measurement Uncertainty per International Guide (Application Note 1449-3), 5988-9215EN for more information on measurement uncertainty.

<sup>12</sup> After zeroing, 30 minutes of power-on warm-up, and 1024 averages.

## Typical power accuracy at 25 °C for U2000/1/2H sensors<sup>13, 14</sup>

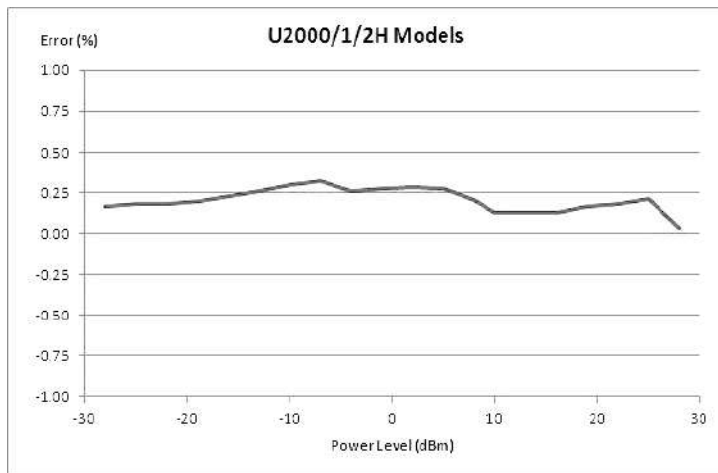

<sup>13</sup> Measurement uncertainty  $\leq 1.9\%$ . At room temperature and excluding power level dependent terms (zero set, drift, and noise). Refer to Keysight Fundamentals of RF and Microwave Power Measurements (Part 3) Power Measurement Uncertainty per International Guide (Application Note 1449-3), 5988-9215EN for more information on measurement uncertainty.

<sup>14</sup> After zeroing, 30 minutes of power-on warm-up, and 1024 averages

## Zero set, zero drift, and measurement noise

### Average only mode

Power range <sup>15</sup>	Zero set (internal)	Zero set (external)	Zero drift <sup>16</sup>	Measurement noise <sup>17</sup>
<b>U2000/1/2A</b>				
-60 to -35 dBm	± 1.5 nW	± 600 pW	200 pW	1 nW
-38 to -15 dBm	± 2 nW	± 1.5 nW	400 pW	1.5 nW
-20 to -6.5 dBm	± 12 nW	± 10 nW	1.5 nW	15 nW
-7.5 to -2 dBm	± 2 µW	± 500 nW	50 nW	650 nW
-4 to 15 dBm	± 4 µW	± 1 µW	500 nW	1 µW
10 to 20 dBm	± 6 µW	± 5 µW	2 µW	10 µW
<b>U2004A</b>				
-60 to -35 dBm	± 2.8 nW	± 600 pW	200 pW	1 nW
-38 to -15 dBm	± 3 nW	± 1.5 nW	400 pW	1.5 nW
-20 to -6.5 dBm	± 12 nW	± 10 nW	1.5 nW	15 nW
-7.5 to -2 dBm	± 2 µW	± 500 nW	50 nW	650 nW
-4 to 15 dBm	± 4 µW	± 1 µW	500 nW	1 µW
10 to 20 dBm	± 6 µW	± 5 µW	2 µW	10 µW
<b>U2000/1/2H</b>				
-50 to -25 dBm	± 15 nW	± 8 nW	2 nW	10 nW
-28 to -5 dBm	± 20 nW	± 20 nW	4 nW	15 nW
-10 to 3.5 dBm	± 120 nW	± 100 nW	15 nW	150 nW
2.5 to 8 dBm	± 20 µW	± 20 µW	500 nW	6.5 µW
6 to 25 dBm	± 40 µW	± 30 µW	5 µW	10 µW
20 to 30 dBm	± 60 µW	± 60 µW	20 µW	100 µW
<b>U2000/1B sensors</b>				
-30 to -5 dBm	± 1.8 µW	± 800 nW	200 nW	1 µW
-8 to 15 dBm	± 2 µW	± 2 µW	400 nW	1.5 µW
10 to 23.5 dBm	± 12 µW	± 10 µW	1.5 µW	15 µW
22.5 to 28 dBm	± 2 mW	± 1 mW	50 nW	650 µW
26 to 44 dBm	± 4 mW	± 2 mW	500 µW	1 mW

<sup>15</sup> Condition: (i) 0 to 55 °C and (ii) 95% relative humidity at 40 °C non-condensing.

<sup>16</sup> Within one hour after zero set, at a constant temperature, after a 24-hour warm-up of the power sensor.

<sup>17</sup> The number of averages at 1 for Normal speed, gate length of 2.27 ms, measured over one-minute interval and two standard deviations.

## Normal mode

Range <sup>18</sup>	Zero set (internal)	Zero set (external)	Zero drift <sup>19</sup>	Measurement noise <sup>20</sup>	Noise per sample <sup>21</sup>
<b>U2000/1/2A</b>					
–38 to –15 dBm	47 nW	43 nW	25 nW	28 nW	90 nW
–20 to –6.5 dBm	530 nW	480 nW	230 nW	300 nW	1 μW
–7.5 to –2 dBm	30 μW	27 μW	19 μW	20 μW	55 μW
–4 to 15 dBm	32 μW	30 μW	24 μW	21 μW	85 μW
10 to 20 dBm	270 μW	200 μW	110 μW	180 μW	550 μW
<b>U2000/1/2H</b>					
–28 to –5 dBm	730 nW	500 nW	300 nW	310 nW	900 nW
–10 to 3.5 dBm	5.3 μW	4.8 μW	3 μW	5 μW	10 μW
–2.5 to 8 dBm	330 μW	270 μW	190 μW	230 μW	550 μW
8 to 25 dBm	440 μW	300 μW	300 μW	260 μW	850 μW
20 to 30 dBm	3.9 μW	2.8 mW	1.1 mW	2.8 mW	5.5 mW
<b>U2000/1B</b>					
–8 to 15 dBm	47 nW	43 μW	25 μW	28 μW	90 μW
10 to 23.5 dBm	530 nW	480 μW	230 μW	300 μW	1 mW
22.5 to 28 dBm	30 μW	27 mW	19 mW	20 mW	55 mW
26 to 44 dBm	32 μW	34 mW	24 mW	21 mW	85 mW

Effect of time-gating and averaging on normal mode measurement noise:

The normal mode measurement noise will depend on the gate length (time-gated period in second) and the number of averages. The noise can be approximately calculated with the following equations.

If the gate length is < 2.73 μs, use Equation 1:

$$\text{Noise} = \text{Noise per sample} \times \frac{1}{\sqrt{\text{Number of averages}}}$$

Otherwise, use Equation 2:

$$\text{Noise} = \text{Noise per sample} \times \frac{1}{\sqrt{\text{Number of averages}}} \times \left( \frac{1}{\text{Gate length}/(0.68 \mu\text{s})} \right)^{1/4}$$

Note: If the noise value obtained from Equation 1 or 2 is lower than the measurement noise specification, use the value as specified in the measurement noise table.

<sup>18</sup> Condition: (i) 0 to 55 °C and (ii) 95% relative humidity at 40 °C non-condensing.

<sup>19</sup> Within one hour after zero set, at a constant temperature, after a 24-hour warm-up of the power sensor.

<sup>20</sup> The number of averages at 1 for Normal speed, gate length of 2.27 ms, measured over one-minute interval and two standard deviations.

<sup>21</sup> The Noise Per Sample specification is only applicable for gated power working range stated in the “Normal Mode Key Specifications and Characteristics” table.

Effects of averaging on noise: Averaging over 1 to 1024 readings is available for reducing noise. The table below provides the measurement noise for a particular sensor with the number of averages set at 16 (for normal mode) and 32 (for x2 mode). Use the noise multiplier, for the appropriate of averages, to determine the total measurement noise value.

Example:

U2000A power sensor, -60 to -35 dBm, normal mode, number of averages = 4

Measurement noise calculation: 1 nW x 1.7 = 1.7 nW

## Average only mode

Number of averages	1	2	4	8	16	32	64	128	256	512	1024
<b>Noise multiplier</b>											
Normal mode	2.0	1.8	1.7	1.5	1.0	0.95	0.74	0.55	0.39	0.29	0.21
x2 mode	2.7	2.4	2.0	1.6	1.0	0.91	0.78	0.53	0.34	0.29	0.20

## Settling time

Manual filter, 10-dB decreasing power step (not across switching points).

Number of averages	1	2	4	8	16	32	64	128	256	512	1024
<b>Noise multiplier</b>											
Normal mode	2.0	1.8	1.7	1.5	1.0	0.95	0.74	0.55	0.39	0.29	0.21
x2 mode	2.7	2.4	2.0	1.6	1.0	0.91	0.78	0.53	0.34	0.29	0.20

## Auto filter, default resolution, 10-dB decreasing power step

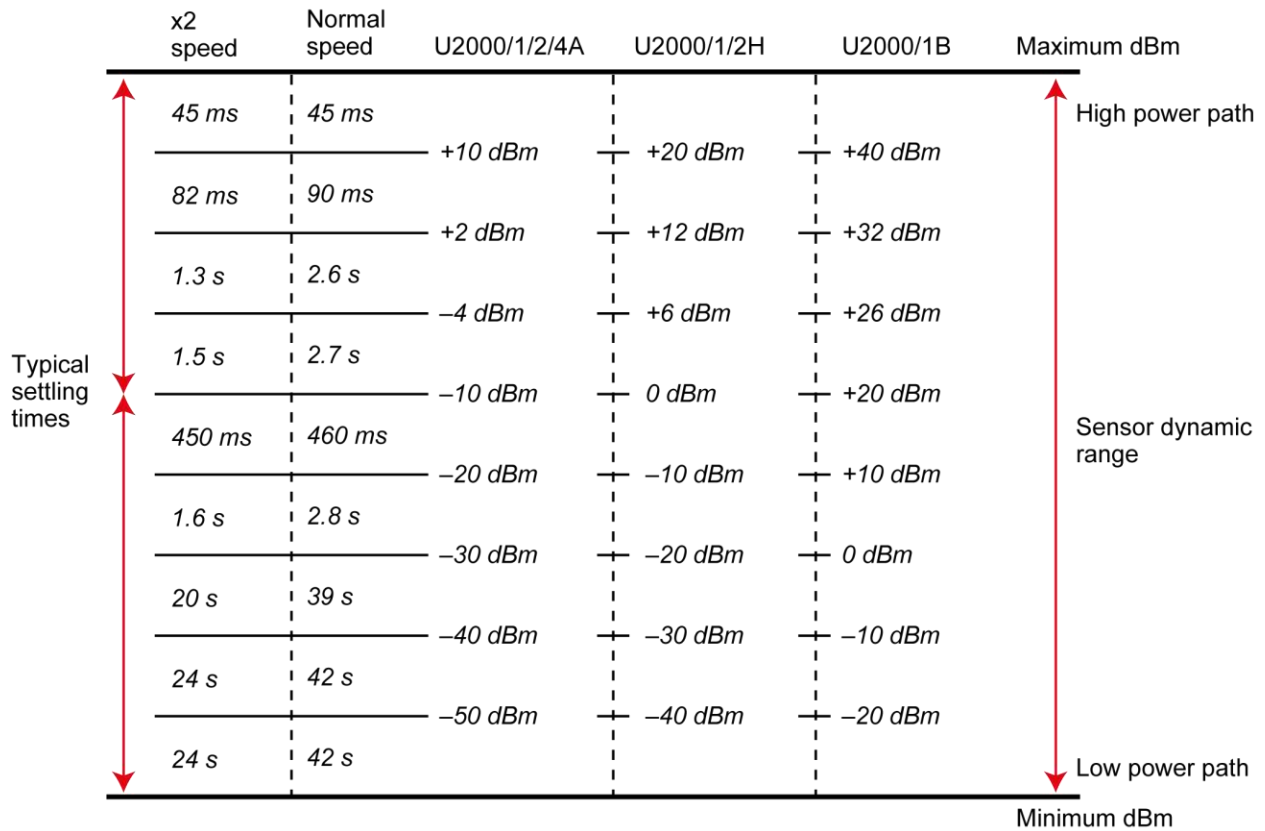

Settling time with auto filter, default resolution, and a 10 dB decreasing power step (not across the switching point) Settling time = 25 ms<sup>22</sup>

<sup>22</sup> When a power step crosses through the sensor's auto-range switching point, add 25 ms.

## Calibration factor and reflection coefficient

Calibration factor (CF) and reflection coefficient (Rho) data is unique to each sensor. The CF corrects for the frequency response of the sensor. The reflection coefficient (Rho or  $\rho$ ) relates to the SWR based on the following formula:

$$SWR = \frac{1 + \rho}{1 - \rho}$$

Maximum relative uncertainties of the CF data are listed in the following table. There is only one set of CF relative uncertainty specification used for both high and low power paths of each sensor.

The uncertainty analysis for the calibration data was done in accordance with the ISO Guide. The uncertainty data reported on the calibration certificate is the expanded uncertainty with a 95% confidence level and a coverage factor of 2.

Frequency	Relative Uncertainty (%) (25 °C ± 10 °C) <sup>23</sup>
<b>U2000A sensor</b>	
10 to 30 MHz	1.8
> 30 MHz to < 2 GHz	1.6
2 to < 14 GHz	2.0
14 to < 16 GHz	2.2
16 to 18 GHz	2.2
<b>U2001A sensor</b>	
10 to 30 MHz	1.8
> 30 MHz to < 2 GHz	1.6
2 to 6 GHz	2.0
<b>U2002A sensor</b>	
50 MHz to 2 GHz	2.0
> 2 to 14 GHz	2.5
> 14 to 16 GHz	2.7
> 16 to 18 GHz	2.7
> 18 to 24 GHz	3.0
<b>U2004A sensor</b>	
9 kHz to 2 GHz	2.0
> 2 to 6 GHz	2.0
<b>U2000B sensor</b>	
10 MHz to 2 GHz	3.0
> 2 to < 12.4 GHz	3.2
12.4 to 18 GHz	3.2

<sup>23</sup> The characterized calibration factor should not deviate between periodic calibrations by more than the specified maximum uncertainty in table. Compliance is confirmed by the relative deviation  $\left(\frac{|CF_1 - CF_2|}{CF_1} * 100\right)$  being less than or equal to  $\sqrt{2}$  times the specified maximum uncertainty.  $\sqrt{2} * U_{max}$  with a reference calibration factor of 100%

Frequency	Relative Uncertainty (%) (25 °C ± 10 °C) <sup>23</sup>
<b>U2001B sensor</b>	
10 MHz to 2 GHz	3.0
> 2 to 6 GHz	3.2
<b>U2000H sensor</b>	
10 MHz to < 8 GHz	2.0
8 to < 12.4 GHz	2.0
12.4 to 18 GHz	2.2
<b>U2001H sensor</b>	
10 MHz to 6 GHz	2.0
<b>U2002H sensor</b>	
50 MHz to < 8 GHz	2.5
8 to < 12.4 GHz	2.5
12.4 to 18 GHz	2.7
> 18 to 24 GHz	3.0

## Trigger

### Internal trigger

Resolution	0.1 dB
Level accuracy	± 1 dB
Jitter	± 1 µs
<b>External TTL trigger input</b>	
Impedance	50 Ω or 1 kΩ <sup>24</sup>
Trigger low	< 1.1 V
Trigger high	> 1.9 V
Minimum trigger pulse width	35 ns
Minimum trigger repetition period	80 ns
Trigger latency	11 µs ± 2 µs
<b>Trigger delay</b>	
Range	-0.15 to + 0.15 s
Resolution	1 µs
<b>Trigger hold-off</b>	
Range	1 µs to 400 ms
Resolution	1 µs
<b>Trigger hysteresis</b>	
Range	0 to +3 dB
Resolution	0.1 dB

<sup>24</sup> This is only available for option U2001A-H16.

## Normal mode key specifications and characteristics

Parameters <sup>25</sup>	Performance
Maximum video bandwidth	40 kHz
Minimum rise time	40 $\mu$ s
Minimum fall time	40 $\mu$ s
Range settling time	150 $\mu$ s
Minimum pulse width	200 $\mu$ s
Sampling rate	1.47 Msps
Maximum capture length	150 ms
Maximum pulse repetition rate	150 kHz
Dynamic range	U2000/1/2A: -30 to +20 dBm
	U2000/1/2H: -10 to +30 dBm
	U2000/1B: 0 to +44 dBm

## General specifications

### Physical characteristics

Dimensions (LxWxH)	U2000/1/4A	163.75 mm x 46.00 mm x 35.90 mm
	U2002A	134.37 mm x 46.00 mm x 35.90 mm
	U2000/1B	308.00 mm x 115.00 mm x 84.00 mm
	U2000/1H	207.00 mm x 46.00 mm x 36.00 mm
	U2002H	164.00 mm x 46.00 mm x 36.00 mm
Weight	U2000/1/4A	0.262 kg
	U2002A	0.226 kg
	U2000/1B	0.762 kg
	U2000/1H	0.324 kg
	U2002H	0.274 kg

### Operating environment

Temperature	0 to 55 °C
Humidity	Up to 95% relative humidity at 40 °C (non-condensing)
Altitude	Up to 4600 m (15,000 ft)
Pollution	Degree 2

### Storage and shipment

Environment	Sensor should be stored in a clean, dry environment
Temperature	-30 to +70 °C
Humidity	Up to 90% relative humidity at 65 °C (non-condensing)
Altitude	Up to 4600 m (15,000 ft)
Pollution	Degree 2

<sup>25</sup> Not applicable for U2004A.

## Physical characteristics

Other	
Current requirement	200 mA max (approximately)
Connector	U2000/1/4A, U2000/1H, U2000/1B: N-type (m), 50 Ω U2002A, U2002H: 3.5 mm (m), 50 Ω
Cable	USB 2.0 Type A to 5-pin Mini-B
Programmability	SCPI, Keysight VEE, LabVIEW, Microsoft® Visual Basic
Safety and EMC compliance	IEC 61010-1:2001/EN 61010-1:2001(2nd edition) IEC 61326:2002/EN61326:1997+A1:1998+A2:2001+A3:2003 Canada: ICES-001:2004 Australia/New Zealand: AS/NZS CISPR11:2004
Calibration <sup>26</sup>	1 year
Warranty <sup>1</sup>	3 years
Compatible instruments	Keysight handheld spectrum analyzers Keysight signal generators Keysight network analyzers Keysight FieldFox RF/Microwave analyzers
Mechanical characteristic	Mechanical characteristics such as center conductor protrusion and pin depth are not performance specifications. They are, however, important supplemental characteristics related to electrical performance. At no time should the pin depth of the connector be protruding

<sup>26</sup> See "Ordering information" for available options.

# Using the U2000 Series with the BenchVue Software

The U2000 Series is supported by the Keysight BenchVue software's BV0007B Power Meter/Sensor Control and Analysis app. Keysight BenchVue software for the PC accelerates testing by providing intuitive, multiple instrument measurement visibility and data capture with no programming necessary. You can derive answers faster than ever by easily viewing, capturing and exporting measurement data and screen shots. BenchVue software license (BV0007B) is now included with your instrument.

For more information, [www.keysight.com/find/BenchVue](http://www.keysight.com/find/BenchVue)

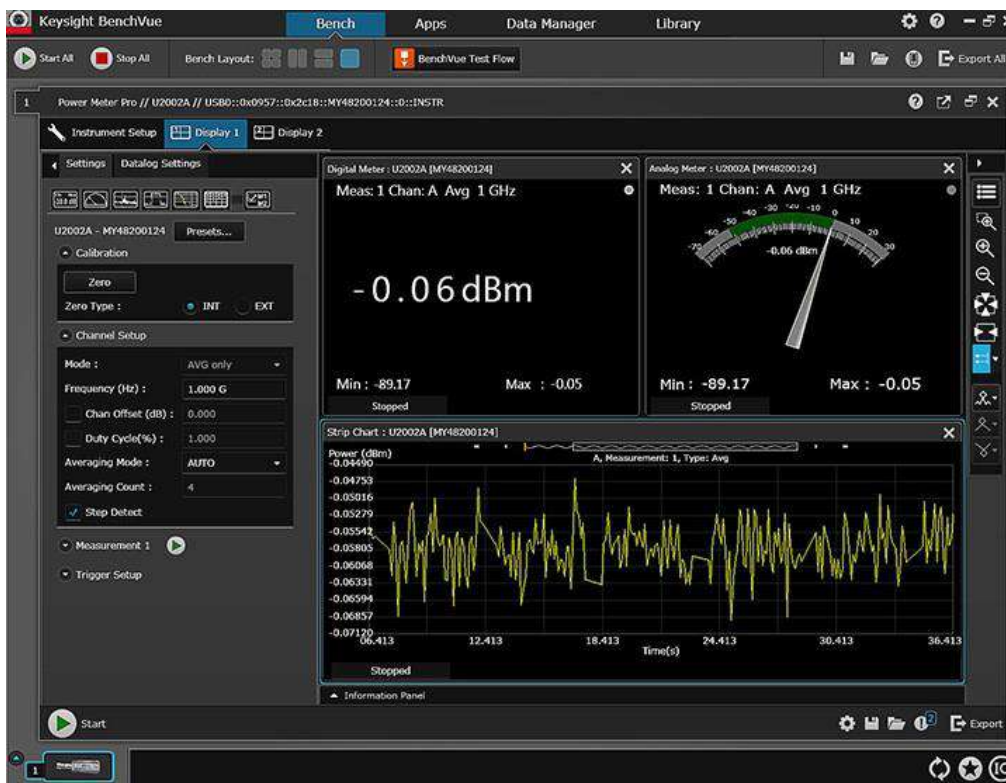

Digital meter, analog meter and datalog view.

### Supported functionality

Measurement displays	Digital meter
	Analog meter
	Data log view
	Trace view (up to 4 channels or traces on one graph)
	Multilist with ratio/delta function
	Compact mode display
Graph functions	Single marker (up to 5 markers per graph)
	Dual marker (up to 2 sets of markers per graph)
	Graph autoscaling
	Graph zooming
	Gate measurement analysis (up to 4-pair of gates)
Pulse characterization functions	17-point automatic pulse parameters characterization
Instrument settings	Save and recall instrument state including graph settings
	Instrument preset settings
	FDO tables
	Full instrumentation control includes frequency/average/trigger settings, zero, etc.
Limit and alert function	Sensors Limit and alert notification
	Alert summary
Export data or screen shots	Data logging (HDF5/MATLAB/Microsoft Excel/Microsoft Word/CSV)
	Save screen capture (PNG/JPEG/BMP)

## System and Installation Requirements

### PC operating system

Windows 10, 8 and 7	Windows 10 32-bit and 64-bit (Professional, Enterprise, Education, Home versions)
	Windows 8 32-bit and 64-bit (Core, Professional, Enterprise)
	Windows 7 SP1 and later 32-bit and 64-bit (Professional, Enterprise, Ultimate)
Computer hardware	Processor: 1 GHz or faster (2 GHz or greater recommended)
	RAM: 1 GB (32-bit) or 2 GB (64-bit) (3 GB or greater recommended)
Windows XP SP3 32-bit (Professional)	Processor: 600 MHz or faster (1 GHz or greater recommended)
	RAM: 1 GB (2 GB or greater recommended)
Interfaces	USB, GPIB, LAN, RS-232
Display resolution	1024 x 768 minimum for single instrument view (higher resolutions are recommended for multiple instrument view)

## Additional requirements

Software: BenchVue requires a VISA (Keysight or National Instruments) when used to connect to physical instruments. Keysight IO Libraries, which contains the necessary VISA, will be installed automatically when BenchVue is installed.

IO Libraries information is available at: [www.keysight.com/find/iosuite](http://www.keysight.com/find/iosuite)

## Ordering Information

### Power sensors

Models	Description	Power range	Connector type
U2000A	10 MHz to 18 GHz USB sensor	-60 to +20 dBm	N-type male, 50 $\Omega$
U2000B	10 MHz to 18 GHz USB sensor	-30 to +44 dBm	N-type male, 50 $\Omega$
U2000H	10 MHz to 18 GHz USB sensor	-50 to +30 dBm	N-type male, 50 $\Omega$
U2001A	10 MHz to 6 GHz USB sensor	-60 to +20 dBm	N-type male, 50 $\Omega$
U2001B	10 MHz to 6 GHz USB sensor	-30 to +44 dBm	N-type male, 50 $\Omega$
U2001H	10 MHz to 6 GHz USB sensor	-50 to +30 dBm	N-type male, 50 $\Omega$
U2002A	50 MHz to 24 GHz USB sensor	-60 to +20 dBm	3.5 mm male, 50 $\Omega$
U2002H	50 MHz to 24 GHz USB sensor	-50 to +30 dBm	3.5 mm male, 50 $\Omega$
U2004A	9 kHz to 6 GHz USB sensor	-60 to +20 dBm	N-type male, 50 $\Omega$

#### Options and accessories

U2001A-H03	U2001A sensor with extended frequency range, 3 MHz to 6 GHz
U2001A-H16	With 1K ohms input trigger impedance. Higher impedance is typically required when several instruments' input trigger ports are connected in parallel for triggering purpose. Standard option has 50 ohms input trigger impedance.
U2001A-H25	U2001A sensor with extended power range, -60 dBm to +25 dBm
U2002A-H26	U2002A sensor with extended frequency range, 10 MHz to 26.5 GHz

#### Standard-shipped accessories

Trigger cable BNC Male to SMB female 50  $\Omega$ , 1.5 m

Power sensor cable: 1.5 m, 3.0 m, or 5.0 m

## Accessories, calibration and documentation options.

Cables	Description
U2031A	USB 2.0 Type A to 5-pin Mini-B cable with secure locking mechanism, 1.5 m (5 ft)
U2031B	USB 2.0 Type A to 5-pin Mini-B cable with secure locking mechanism, 3.0 m (10 ft)
U2031C	USB 2.0 Type A to 5-pin Mini-B cable with secure locking mechanism, 5.0 m (16.4 ft)
U2032A	BNC (m) to SMB (f) trigger cable, 1.5 m, 50 W
Travel kits	Description
U2000A-201	Transit case <sup>27</sup> (500mm (L) x 399mm (W) x 138mm (H))
U2000A-202	Soft carrying case (405mm (L) x 270mm (W) x 175mm (H))
U2000B-201	Transit case <sup>28</sup> (500mm (L) x 400mm (W) x 180mm (H))
U2000A-204	Soft carrying pouch (210mm (L) x 150mm (W) x 70mm (H))
Hanging kit	Description
U2000A-203	Holster (104mm (L) x 50mm (W) x 39mm (H))
Calibration	Description
Option 1A7	ISO 17025 calibration with test data
Option A6J	ANSI Z540 calibration with test data
Software	Description
BV0007B	BenchVue Power Meter/Sensor Control and Analysis app license



U2000A/B-201  
Transit case



U2000A-202  
Soft carrying case



U2000A-203  
Holster



U2000A-204  
Soft carrying pouch

<sup>27</sup> U2000A-201 transit case for A model only.

<sup>28</sup> U2000B-201 transit case for B and H model.

Keysight enables innovators to push the boundaries of engineering by quickly solving design, emulation, and test challenges to create the best product experiences. Start your innovation journey at [www.keysight.com](http://www.keysight.com).