

R&S®NRT2

Power Reflection Meter

User Manual



1178555002
Version 06

ROHDE & SCHWARZ
Make ideas real



This manual describes the R&S®NRT2 (1430.0509K02) with firmware version FW 01.10 and later.
In addition to the base unit, the following options are described:

- R&S®NRT2-B8 (1430.0105K02)

© 2022 Rohde & Schwarz GmbH & Co. KG
Muehldorfstr. 15, 81671 Muenchen, Germany
Phone: +49 89 41 29 - 0
Email: info@rohde-schwarz.com
Internet: www.rohde-schwarz.com

Subject to change – data without tolerance limits is not binding.

R&S® is a registered trademark of Rohde & Schwarz GmbH & Co. KG.

Trade names are trademarks of the owners.

1178.5550.02 | Version 06 | R&S®NRT2

Throughout this manual, products from Rohde & Schwarz are indicated without the ® symbol , e.g. R&S®NRT2 is indicated as R&S NRT2.

Contents

1	Safety and regulatory information.....	9
1.1	Safety Instructions.....	9
1.2	Labels on the product.....	11
1.3	Warning messages in the documentation.....	12
1.4	Korea Certification Class B.....	12
2	Welcome.....	13
2.1	Documentation Overview.....	13
2.1.1	Getting Started Manual.....	13
2.1.2	User Manual.....	13
2.1.3	Instrument Security Procedures.....	13
2.1.4	Printed Safety Instructions.....	13
2.1.5	Data Sheets and Brochures.....	13
2.1.6	Release Notes and Open Source Acknowledgment (OSA).....	14
2.2	Key Features.....	14
3	Getting Started.....	15
3.1	Preparing for Use.....	15
3.1.1	Lifting and Carrying.....	15
3.1.2	Unpacking and Checking.....	15
3.1.3	Choosing the Operating Site.....	15
3.1.4	Setting Up the Product.....	16
3.1.4.1	Placing the Product on a Bench Top.....	16
3.1.4.2	Mounting the Product in a Rack.....	17
3.1.5	Considerations for Test Setup.....	18
3.1.6	Connecting to Power.....	18
3.1.7	Connecting to LAN.....	19
3.1.8	Connecting Power Sensors.....	19
3.1.8.1	NRT Sensor Connector.....	19
3.1.8.2	USB 2.0 Host Interfaces.....	20
3.1.9	Connecting USB and External Devices.....	20
3.1.10	Switching On or Off.....	21
3.2	Instrument Tour.....	22

3.2.1	Front Panel Tour.....	22
3.2.1.1	NRT Sensor.....	22
3.2.1.2	Touchscreen.....	22
3.2.1.3	Keys.....	23
3.2.1.4	USB Host Interface.....	24
3.2.1.5	On/Standby Key.....	25
3.2.2	Rear Panel Tour.....	25
3.2.2.1	Trig In / Out 2 and Out 1 / Trig Out Connectors.....	25
3.2.2.2	Ethernet Interface.....	26
3.2.2.3	USB Device Interface.....	26
3.2.2.4	USB Host Interface.....	26
3.2.2.5	AC Supply and Power Switch.....	26
3.2.2.6	IEC 625/IEEE 488 Interface.....	26
3.2.2.7	Name Plate.....	27
4	Operating Concepts.....	28
4.1	Manual Operation.....	28
4.1.1	Main Measurement Dialog.....	28
4.1.1.1	Measurement Pane.....	29
4.1.2	Status Information.....	30
4.1.3	Notification Center.....	31
4.1.4	Editing Parameters.....	33
4.1.5	Creating and Saving Screenshots.....	33
4.2	Remote Control.....	34
4.2.1	Switching to Remote Control (REMOTE).....	34
4.2.2	Returning to Manual Operation (LOCAL).....	35
5	Measurement and Display Configuration.....	36
5.1	Main Measurement Dialog.....	36
5.2	Measurement Overview.....	42
5.3	Measurement Main Configuration Dialog.....	43
5.4	Controlling the Measurement.....	44
5.5	Triggering.....	45
5.5.1	Trigger States.....	45
5.5.2	Trigger Sources.....	45

5.5.3	Trigger Settings.....	46
5.6	Measurement Representation.....	46
6	Sensor Configuration.....	50
6.1	Mode Settings.....	50
6.2	Correction Settings.....	52
6.3	Sensor Frequency.....	54
6.4	Filter Settings.....	55
7	Saving and Recalling Settings.....	57
8	Zeroing Sensors.....	59
9	System Settings.....	61
9.1	Connections.....	61
9.1.1	Network Settings.....	62
9.1.2	Remote Settings.....	65
9.1.3	Input/Output Settings (I/O).....	68
9.1.4	Sensor Manager.....	70
9.2	Instrument Info.....	73
9.2.1	System Info.....	73
9.2.2	Security Settings.....	76
9.2.3	Option Settings.....	79
9.2.4	Open Source Licenses.....	81
9.3	Hardware Configuration.....	81
9.4	Test.....	82
9.5	Global Settings.....	83
10	Firmware Update.....	85
10.1	Firmware Update via PC and USB or Ethernet Connection.....	85
10.1.1	Hardware and Software Requirements.....	85
10.1.2	Preparing an Update.....	86
10.1.3	Updating the Application Firmware.....	87
10.2	Firmware Update via a USB Flash Memory Stick.....	90
10.2.1	Hardware and Software Requirements.....	90
10.2.2	Preparing an Update.....	90
10.2.3	Updating the Application Firmware.....	91

11 Remote Control.....	92
11.1 Notation for SCPI Commands.....	92
11.2 Status Reporting System.....	93
11.2.1 Hierarchy of the Status Registers.....	93
11.2.2 Structure of a SCPI Status Register.....	94
11.2.3 Status Byte (STB) and Service Request Enable Register (SRE).....	96
11.2.4 IST Flag and Parallel Poll Enable Register (PPE).....	97
11.2.5 Questionable Status Register.....	97
11.2.6 Standard Event Status and Enable Register (ESR, ESE).....	98
11.2.7 Operation Status Register.....	99
11.3 Common Commands.....	100
11.4 CALCulate.....	109
11.5 CALibration.....	130
11.6 DIAGnostic.....	130
11.7 FORMat.....	131
11.8 FREQUENCY.....	131
11.9 INPut.....	132
11.10 MMEMory.....	133
11.11 OUTPut.....	142
11.12 SENSE.....	147
11.13 SERvice.....	161
11.14 STATus.....	161
11.15 SYSTem.....	165
11.16 TEST.....	183
11.17 TRIGGER.....	184
11.18 UNIT.....	186
12 Troubleshooting.....	189
12.1 Displaying Information.....	189
12.2 Notifications.....	189
12.2.1 Interpreting Notifications and Their Number.....	189
12.2.1.1 System Notifications.....	190
12.2.1.2 Power Sensor Notifications.....	191
12.2.1.3 License Key Notifications.....	191

12.2.1.4	Queue Handling Notifications.....	191
12.3	Performing Tests.....	191
12.4	Collecting Information for Technical Support.....	192
12.5	Contacting Customer Support.....	192
13	Transporting.....	193
14	Maintenance, Storage and Disposal.....	194
14.1	Cleaning.....	194
14.2	Storage.....	194
14.3	Disposal.....	194
	Glossary: List of Abbreviations.....	195
	List of commands.....	197
	Index.....	203

1 Safety and regulatory information

The product documentation helps you use the product safely and efficiently. Follow the instructions provided here and in the following chapters.

Intended use

Combined with a supported R&S NRT-Zxx directional power sensor, the R&S NRT2 base unit is intended for power and reflection measurements in development and for monitoring and maintenance purposes. The supported R&S NRT-Zxx directional power sensors are listed in the data sheet. Observe the operating conditions and performance limits stated in the data sheet.

Target audience

The target audience is developers and technicians. The required skills and experience in power and reflection measurements depend on the used operating concept. While manual operation is suitable for beginners, remote control requires expertise in power and reflection measurements.

Main applications are continuous monitoring of transmitter systems and power measurements with digital modulation. A profound knowledge of the intended application and test setup is recommended.

Where do I find safety information?

Safety information is part of the product documentation. It warns you of potential dangers and gives instructions on how to prevent personal injury or damage caused by dangerous situations. Safety information is provided as follows:

- In [Chapter 1.1, "Safety Instructions"](#), on page 9. The same information is provided in many languages as printed "Safety Instructions". The printed "Safety Instructions" are delivered with the product.
- Throughout the documentation, safety instructions are provided when you need to take care during setup or operation.

1.1 Safety Instructions

Products from the Rohde & Schwarz group of companies are manufactured according to the highest technical standards. To use the products safely, follow the instructions provided here and in the product documentation. Keep the product documentation nearby and offer it to other users.

Use the product only for its intended use and within its performance limits. Intended use and limits are described in the product documentation such as the data sheet, manuals and the printed "Safety Instructions". If you are unsure about the appropriate use, contact Rohde & Schwarz customer service.

Using the product requires specialists or specially trained personnel. These users also need sound knowledge of at least one of the languages in which the user interfaces and the product documentation are available.

Never open the casing of the product. Only service personnel authorized by Rohde & Schwarz are allowed to repair the product. If any part of the product is damaged or broken, stop using the product. Contact Rohde & Schwarz customer service at <http://www.customersupport.rohde-schwarz.com>.

Lifting and carrying the product

The maximum weight of the product is provided in the data sheet. To move the product safely, you can use lifting or transporting equipment such as lift trucks and forklifts. Follow the instructions provided by the equipment manufacturer.

Choosing the operating site

Only use the product indoors. The product casing is not waterproof. Water that enters can electrically connect the casing with live parts, which can lead to electric shock, serious personal injury or death if you touch the casing. If Rohde & Schwarz provides accessories designed for your product, e.g. a carrying bag, you can use the product outdoors.

Unless otherwise specified, you can operate the product up to an altitude of 2000 m above sea level. The product is suitable for pollution degree 2 environments where nonconductive contamination can occur. For more information on environmental conditions such as ambient temperature and humidity, see the data sheet.

Setting up the product

Always place the product on a stable, flat and level surface with the bottom of the product facing down. If the product is designed for different positions, secure the product so that it cannot fall over.

If the product has foldable feet, always fold the feet completely in or out to ensure stability. The feet can collapse if they are not folded out completely or if the product is moved without lifting it. The foldable feet are designed to carry the weight of the product, but not an extra load.

If stacking is possible, keep in mind that a stack of products can fall over and cause injury.

If you mount products in a rack, ensure that the rack has sufficient load capacity and stability. Observe the specifications of the rack manufacturer. Always install the products from the bottom shelf to the top shelf so that the rack stands securely. Secure the product so that it cannot fall off the rack.

Connecting to power

The product is an overvoltage category II product. Connect the product to a fixed installation used to supply energy-consuming equipment such as household appliances and similar loads. Keep in mind that electrically powered products have risks, such as electric shock, fire, personal injury or even death.

Take the following measures for your safety:





- Before switching on the product, ensure that the voltage and frequency indicated on the product match the available power source. If the power adapter does not adjust automatically, set the correct value and check the rating of the fuse.
- Only use the power cable delivered with the product. It complies with country-specific safety requirements. Only insert the plug into an outlet with protective conductor terminal.
- Only use intact cables and route them carefully so that they cannot be damaged. Check the power cables regularly to ensure that they are undamaged. Also ensure that nobody can trip over loose cables.
- If the product needs an external power supply, use the power supply that is delivered with the product or that is recommended in the product documentation or a power supply that conforms to the country-specific regulations.
- Only connect the product to a power source with a fuse protection of maximum 20 A.
- Ensure that you can disconnect the product from the power source at any time. Pull the power plug to disconnect the product. The power plug must be easily accessible. If the product is integrated into a system that does not meet these requirements, provide an easily accessible circuit breaker at the system level.

Cleaning the product

Use a dry, lint-free cloth to clean the product. When cleaning, keep in mind that the casing is not waterproof. Do not use liquid cleaning agents.

Meaning of safety labels

Safety labels on the product warn against potential hazards.

	<p>Potential hazard</p> <p>Read the product documentation to avoid personal injury or product damage.</p>
	<p>Electrical hazard</p> <p>Indicates live parts. Risk of electric shock, fire, personal injury or even death.</p>
	<p>Hot surface</p> <p>Do not touch. Risk of skin burns. Risk of fire.</p>
	<p>Protective conductor terminal</p> <p>Connect this terminal to a grounded external conductor or to protective ground. This connection protects you against electric shock if an electric problem occurs.</p>

1.2 Labels on the product

Labels on the casing inform about:

- Personal safety, see "[Meaning of safety labels](#)" on page 11

- Environment safety, see [Table 1-1](#)
- Identification of the product, see [Chapter 3.2.2.7, "Name Plate"](#), on page 27.

Table 1-1: Labels regarding environment safety

	<p>Labeling in line with EN 50419 for disposal of electrical and electronic equipment after the product has come to the end of its service life.</p> <p>For more information, see "Disposing electrical and electronic equipment" on page 194.</p>
---	--

1.3 Warning messages in the documentation

A warning message points out a risk or danger that you need to be aware of. The signal word indicates the severity of the safety hazard and how likely it will occur if you do not follow the safety precautions.

WARNING

Potentially hazardous situation. Could result in death or serious injury if not avoided.

CAUTION

Potentially hazardous situation. Could result in minor or moderate injury if not avoided.

NOTICE

Potential risks of damage. Could result in damage to the supported product or to other property.

1.4 Korea Certification Class B



이 기기는 가정용(B급) 전자파 적합기기로서 주로 가정에서 사용하는 것을 목적으로 하며, 모든 지역에서 사용할 수 있습니다.

2 Welcome

This chapter provides an overview of the user documentation and an introduction to the R&S NRT2.

2.1 Documentation Overview

This section provides an overview of the R&S NRT2 user documentation. Unless specified otherwise, you find the documents on the R&S NRT2 product page at:

www.rohde-schwarz.com/manual/NRT2

2.1.1 Getting Started Manual

Introduces the R&S NRT2 and describes how to set up and start working with the product. A printed version is delivered with the instrument.

2.1.2 User Manual

Contains the description of all instrument modes and functions. It also provides an introduction to remote control, a complete description of the remote control commands with programming examples, and information on maintenance, instrument interfaces and error messages. Includes the contents of the getting started manual .

2.1.3 Instrument Security Procedures

Deals with security issues when working with the R&S NRT2 in secure areas. It is available for download on the Internet.

2.1.4 Printed Safety Instructions

Provides safety information in many languages. The printed document is delivered with the product.

2.1.5 Data Sheets and Brochures

The data sheet contains the technical specifications of the R&S NRT2. It also lists the firmware applications and their order numbers, and optional accessories.

The brochure provides an overview of the instrument and deals with the specific characteristics.

See www.rohde-schwarz.com/brochure-datasheet/NRT2

2.1.6 Release Notes and Open Source Acknowledgment (OSA)

The release notes list new features, improvements and known issues of the current firmware version.

The open source acknowledgment and the license texts of open source software packages used in the R&S NRT2 software are provided under:

[System] > "Instrument Info" > "Open Source Options"

For further details, see [Chapter 9.2.4, "Open Source Licenses"](#), on page 81.

See www.rohde-schwarz.com/firmware/NRT2

2.2 Key Features

Directional power measurements, measuring forward and reverse power under operating conditions, are required when installing, servicing and monitoring transmitters, antennas and RF generators. The compact R&S NRT2 power reflection meter supports all the measurement functions of the R&S NRT-Zxx directional power sensors. Thanks to the wide range of measurement functions and high accuracy, you can use them in research, development and production.

The large, user-friendly touchscreen simultaneously displays the forward and reverse power. The base unit is exceptionally easy and intuitive to use and can be remotely controlled via LAN, GPIB (GPIB/IEEE488 Interface (R&S NRT2-B8)) or USB.

Key facts:

- Simultaneous display of forward and reverse power
- Measurement of average power, average burst power, peak power, crest factor, CCDF and mismatch
- 5" color touchscreen
- Direct operation of the R&S NRT-Zxx directional power sensors from a PC
- Frequency-range from 25 MHz to 4 GHz (sensor-dependent)

3 Getting Started

3.1 Preparing for Use

Here, you can find basic information about setting up the product for the first time.

• Lifting and Carrying	15
• Unpacking and Checking	15
• Choosing the Operating Site	15
• Setting Up the Product	16
• Considerations for Test Setup	18
• Connecting to Power	18
• Connecting to LAN	19
• Connecting Power Sensors	19
• Connecting USB and External Devices	20
• Switching On or Off	21

3.1.1 Lifting and Carrying

See "[Lifting and carrying the product](#)" on page 10.

The R&S NRT2 weighs below 3 kg, details are provided in the data sheet. Due to the low weight, you can move the R&S NRT2 easily.

3.1.2 Unpacking and Checking

1. Unpack the product carefully.
2. Retain the original packing material. Use it when transporting or shipping the product later.
3. Using the delivery notes, check the equipment for completeness.
4. Check the equipment for damage.

If the delivery is incomplete or equipment is damaged, contact Rohde & Schwarz.

3.1.3 Choosing the Operating Site

Specific operating conditions ensure proper operation and avoid damage to the product and connected devices. For information on environmental conditions such as ambient temperature and humidity, see the data sheet.

See also "[Choosing the operating site](#)" on page 10.

Electromagnetic compatibility classes

The electromagnetic compatibility (EMC) class indicates where you can operate the product. The EMC class of the product is given in the data sheet under "General data".

- Class B equipment is suitable for use in:
 - Residential environments
 - Environments that are directly connected to a low-voltage supply network that supplies residential buildings
- Class A equipment is intended for use in industrial environments. It can cause radio disturbances in residential environments due to possible conducted and radiated disturbances. It is therefore not suitable for class B environments. If class A equipment causes radio disturbances, take appropriate measures to eliminate them.

3.1.4 Setting Up the Product

See also:

- ["Setting up the product"](#) on page 10
- ["Intended use"](#) on page 9

3.1.4.1 Placing the Product on a Bench Top

The R&S NRT2 is a small and lightweight product. You can stack the R&S NRT2 with other products, but place the R&S NRT2 on top. In the following procedure, the weight indication for stacking refers to the most common design of larger Rohde & Schwarz instruments. Verify the load suitable for your product before stacking.

To place the product on a bench top

1. Place the product on a stable, flat and level surface. Ensure that the surface can support the weight of the product. For information on the weight, see the data sheet.
2. **CAUTION!** Foldable feet can collapse. See ["Setting up the product"](#) on page 10. Always fold the feet completely in or out. With folded-out feet, do not place anything on top or underneath the product.
3. **WARNING!** A stack of products can fall over and cause injury. Never stack more than three products on top of each other. Instead, mount them in a rack.

Stack as follows:

- If the products have foldable feet, fold them in completely.
- It is best if all products have the same dimensions (width and length). If the products have different dimensions, stack according to size and place the smallest product on top.
- Do not exceed the permissible total load placed on the product at the bottom of the stack:
 - 50 kg when stacking products of identical dimensions (left figure).

- 25 kg when stacking smaller products on top (middle figure).

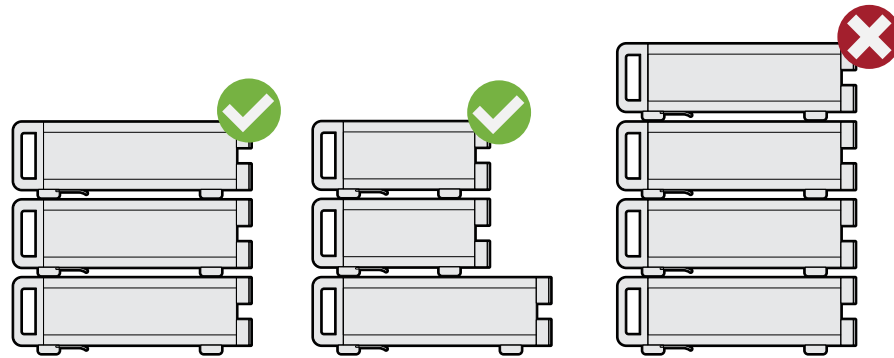

Left = Stacked correctly, same dimensions
 Middle = Stacked correctly, different dimensions
 Right = Stacked incorrectly, too many products

4. **NOTICE!** Overheating can damage the product.

Prevent overheating as follows:

- Keep a minimum distance of 10 cm between the fan openings of the product and any object in the vicinity.
- Do not place the product next to heat-generating equipment such as radiators or other products.

3.1.4.2 Mounting the Product in a Rack

To prepare the rack

1. Observe the requirements and instructions in "[Setting up the product](#)" on page 10.
2. **NOTICE!** Insufficient airflow can cause overheating and damage the product.
Design and implement an efficient ventilation concept for the rack.

To mount the product in a rack

1. Use an adapter kit to prepare the product for rack mounting.
 - a) Order the rack adapter kit designed for the product. For the order number, see data sheet.
 - b) Mount the adapter kit. Follow the assembly instructions provided with the adapter kit.
2. Grab the product by the handles and push it onto the shelf until the rack brackets fit closely to the rack.
3. Tighten all screws on the rack brackets to secure the product in the rack.

To unmount the product from a rack

1. Loosen the screws at the rack brackets.

2. Remove the product from the rack.
3. If placing the product on a bench top again, unmount the adapter kit from the product. Follow the instructions provided with the adapter kit.

3.1.5 Considerations for Test Setup

Cable selection and electromagnetic interference (EMI)

Electromagnetic interference (EMI) can affect the measurement results.

To suppress electromagnetic radiation during operation:

- Use high-quality shielded cables, for example, double-shielded RF and LAN cables.
- Always terminate open cable ends.
- Ensure that connected external devices comply with EMC regulations.
- Do not use USB connecting cables exceeding 5 m.

Preventing electrostatic discharge (ESD)

Electrostatic discharge is most likely to occur when you connect or disconnect a DUT.

- ▶ **NOTICE!** Risk of electrostatic discharge. Electrostatic discharge can damage the electronic components of the product and the device under test (DUT).

Ground yourself to prevent electrostatic discharge damage:

- a) Use a wrist strap and cord to connect yourself to ground.
- b) Use a conductive floor mat and heel strap combination.

3.1.6 Connecting to Power

The R&S NRT2 can be used with different AC power voltages and adapts itself automatically to them. Adjusting the R&S NRT2 to a particular AC supply voltage is therefore not required. Refer to the data sheet for the requirements of voltage and frequency.

For safety information, see ["Connecting to power"](#) on page 10.

1. Plug the AC power cable into the AC power connector on the rear panel of the product. Only use the AC power cable delivered with the product.
2. Plug the AC power cable into a power outlet with ground contact.

The required ratings are listed next to the AC power connector and in the data sheet.

Further information:

- [Chapter 3.2.2.5, "AC Supply and Power Switch"](#), on page 26

3.1.7 Connecting to LAN

See [Chapter 9.1.1, "Network Settings"](#), on page 62.

3.1.8 Connecting Power Sensors

The R&S NRT2 supports the R&S NRT-Zxx directional power sensors listed in the data sheet. You have two choices for connecting the power sensors, but only one measurement at a time is possible.

3.1.8.1 NRT Sensor Connector

See [Figure 3-2](#).

Communication between the R&S NRT-Zxx directional power sensor and a base unit is only possible with a baud rate setting of 38400 Bd. This setting is the factory default that must be restored if the setting was changed. If the R&S NRT-Zxx directional power sensor is not recognized by the base unit, check that the baud rate setting of the R&S NRT-Zxx directional power sensor is 38400 Bd.

See the manual of the R&S NRT-Zxx directional power sensor for details.

The arrow on the power sensor casing shows the forward power flow.

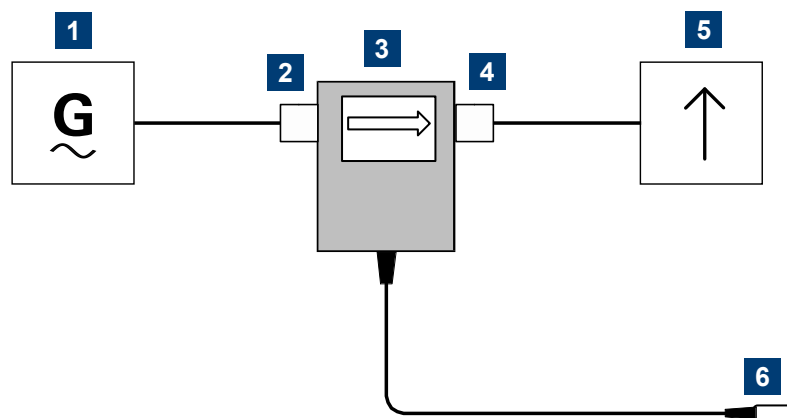

Figure 3-1: Connecting to source and load

- 1 = source
- 2 = port 1 (RF connector)
- 3 = R&S NRT-Zxx directional power sensor
- 4 = port 2 (RF connector)
- 5 = load
- 6 = host interface connector

To connect the R&S NRT-Zxx directional power sensor

Connect the R&S NRT-Zxx directional power sensor between source and load of your test setup as follows.

1. **CAUTION!** Risk of electric shock and severe skin burns. During the measurement, the RF power flow can be high. Connect both RF connectors tightly to avoid power leakage.
Connect RF connector (2, port 1) to the source.
 - a) Insert RF connector (2) straight into the RF connector of the source. Take care not to tilt the R&S NRT-Zxx directional power sensor.
 - b) Tighten the RF connector securely by hand.
2. Connect RF connector (4, port 2) to the load.
 - a) Insert RF connector (4) straight into the RF connector of the load. Take care not to tilt the R&S NRT-Zxx directional power sensor.
 - b) Tighten the RF connector securely by hand.
3. Connect the host interface connector of the R&S NRT-Zxx directional power sensor (6) to the NRT sensor connector.

To disconnect the R&S NRT-Zxx directional power sensor

1. **CAUTION!** Risk of electric shock and severe skin burns. During the measurement, the RF power flow can be high.
Switch off the RF power before touching the RF connectors.
2. Unscrew the RF connectors by hand.
3. Disconnect the cable of the R&S NRT-Zxx directional power sensor (6) from the NRT sensor connector.

3.1.8.2 USB 2.0 Host Interfaces

See [Figure 3-2](#) and [Chapter 3.2.2.4, "USB Host Interface"](#), on page 26.

1. Connect the R&S NRT-Z5 USB interface adapter to the R&S NRT-Zxx power sensor.
2. Connect the USB connector of the adapter to the R&S NRT2.
3. Connect the R&S NRT-Zxx power sensor between source and load. See [Chapter 3.1.8.1, "NRT Sensor Connector"](#), on page 19.

3.1.9 Connecting USB and External Devices

Apart from connecting power sensors, you can use the USB interfaces to connect USB devices. You can increase the number of connected devices by using USB hubs.

Due to the large number of available USB devices, there is almost no limit to the possible expansions. In the following, useful USB devices are listed exemplarily:

- Memory stick for easy transfer of data to/from a computer (e.g. firmware updates).
- Mouse if you prefer this way of operation over a touchscreen.

3.1.10 Switching On or Off

Table 3-1: Overview of power states

Status	LED	Position of power switch
Off	Off	[0]
Standby	● orange	[1]
Ready	● green	[1]

To switch on the product

The product is off but connected to power.

1. Set the switch on the power supply to position [1]. See [Chapter 3.2.2.5, "AC Supply and Power Switch"](#), on page 26.
The LED of the [standby] key is orange. See [Chapter 3.2.1.5, "On/Standby Key"](#), on page 25.
2. Press the [standby] key.
The LED changes to green. The product boots.
See [Chapter 4.1.1, "Main Measurement Dialog"](#), on page 28.
If the previous session ended regularly, the product uses the settings from the last session.
3. If you want to return to a defined initial state, perform a preset.
See ["Preset"](#) on page 58.

To shut down the product

The product is in the ready state.

- ▶ Press the [standby] key.
The operating system shuts down. The LED changes to orange.

To disconnect from power

The product is in the standby state.

1. **NOTICE!** Risk of data loss. If you disconnect the product from power when it is in the ready state, you can lose settings and data. Shut it down first.
Set the switch on the power supply to position [0].
The LED of the standby key is switched off.
2. Disconnect the product from the power source.

Further information:

- [Chapter 7, "Saving and Recalling Settings"](#), on page 57
- [Chapter 3.2.1.5, "On/Standby Key"](#), on page 25

3.2 Instrument Tour

The meanings of the labels on the product are described in [Chapter 1.2, "Labels on the product"](#), on page 11.

- [Front Panel Tour](#).....22
- [Rear Panel Tour](#)..... 25

3.2.1 Front Panel Tour



Figure 3-2: Front panel of the R&S NRT2

- 1 = NRT sensor connector, see [Chapter 3.2.1.1, "NRT Sensor"](#), on page 22.
- 2 = Touchscreen, see [Chapter 3.2.1.2, "Touchscreen"](#), on page 22.
- 3 = USB host interface, see [Chapter 3.2.1.4, "USB Host Interface"](#), on page 24.
- 4 = On/standby key, see [Chapter 3.2.1.5, "On/Standby Key"](#), on page 25.
- 5, 7 = Keys, see [Chapter 3.2.1.3, "Keys"](#), on page 23.
- 6 = Cursor keys, see ["Cursor keys"](#) on page 24.

3.2.1.1 NRT Sensor

See (1) in [Figure 3-2](#).

To the left of the display, the R&S NRT2 provides the sensor interface. For supported power sensors, see the product brochure.

Further information:

- [Chapter 3.1.8, "Connecting Power Sensors"](#), on page 19

3.2.1.2 Touchscreen

See (2) in [Figure 3-2](#).

The R&S NRT2 displays results in panes. Depending on the measurement mode, values are displayed digitally or graphically.



False triggers can occur

If an object (e.g. a human finger) that is charged with static electricity is brought near the touch panel, false triggers can occur.

This behavior is caused by the principle of operation of a PCAP (projected capacitive) touch panel.

Further information:

- ["Using the touchscreen"](#) on page 28

3.2.1.3 Keys

See (3) in [Figure 3-2](#).

Esc

[Esc] / Local

If you press shortly:

- Changes to the next-higher hierarchy level.
- Escapes from the entry mode in text boxes and lists.
- Closes dialogs without losing any entries that have been made.
- Switches from remote control mode (all controls disabled) to manual operation.

If you press and hold:

- Goes to the main measurement dialog.
See [Chapter 4.1.1, "Main Measurement Dialog"](#), on page 28.

Further information:

- ["Going back to a higher hierarchy level"](#) on page 28
- [Chapter 4.2.2, "Returning to Manual Operation \(LOCAL\)"](#), on page 35



Screenshot

Creates a screenshot of the current display.

See [Chapter 4.1.5, "Creating and Saving Screenshots"](#), on page 33.

Remote command:

[SYSTem:HCOPY](#) on page 175

1 Trig

[1Trig] / Delete

- Controls the measurements depending on the trigger mode:
 - For all trigger modes except "Single", starts and stops the measurement.
 - For the "Single" trigger mode, enables and triggers the measurement.

Changes of the trigger state apply to all measurements.

See also ["Trigger Mode"](#) on page 46.

- Deletes numbers or text in a field so that you can enter a new value.



Enter

- Confirms entries in text fields, dialogs and selections in lists.
- Shows a frame around the control in focus. You can change the focus using the [Cursor keys](#).

Freq

[Freq]

Sets the carrier frequency of the applied signal. This value is used for frequency-response correction of the measurement result.

Remote command:

[\[SENSe<Sensor>:\] FREQuency \[:CW\]](#) on page 151

★

Favorites

Reserved for future use.

Preset

[Preset]

Opens the "Save / Recall / Preset" dialog.

See [Chapter 7, "Saving and Recalling Settings"](#), on page 57.

If you press [Preset] again, the preset function starts.

See ["Preset"](#) on page 58.

If you press the [Preset] key during booting, the R&S NRT2 starts with the factory default state.

Zero

[Zero]

Pressing [Zero] opens the "Zeroing Sensors" dialog.

If you press [Zero] again, zeroing starts.

Also displays status information:

- Zeroing status
- Sensor status

System

[System]

Opens the "System Overview" dialog.

See [Chapter 9, "System Settings"](#), on page 61.

Cursor keys

See (4) in [Figure 3-2](#).

The cursor keys are context-sensitive. The control in focus is indicated by a focus frame. Use the cursor keys as follows:

- Selecting an element in the navigation pane.
- Selecting the active pane.
- Selecting an element from a list.
- Moving the cursor in text boxes.
- Changing the value of an entry in a text box.

3.2.1.4 USB Host Interface

See (5) in [Figure 3-2](#).

USB 2.0 (universal serial bus) interface of the type A (host USB). Used to connect:

- R&S NRT-Zxx power sensor using the R&S NRT-Z5 USB interface adapter
- External devices like a keyboard, mouse, or memory stick

Further information:

- [Chapter 3.1.8.2, "USB 2.0 Host Interfaces"](#), on page 20
- [Chapter 3.1.9, "Connecting USB and External Devices"](#), on page 20

3.2.1.5 On/Standby Key

See (6) in [Figure 3-2](#).

The on/standby key switches between standby and ready state, if the power switch is set to [I].

Further information:

- [Chapter 3.2.2.5, "AC Supply and Power Switch"](#), on page 26
- [Chapter 3.1.10, "Switching On or Off"](#), on page 21

3.2.2 Rear Panel Tour

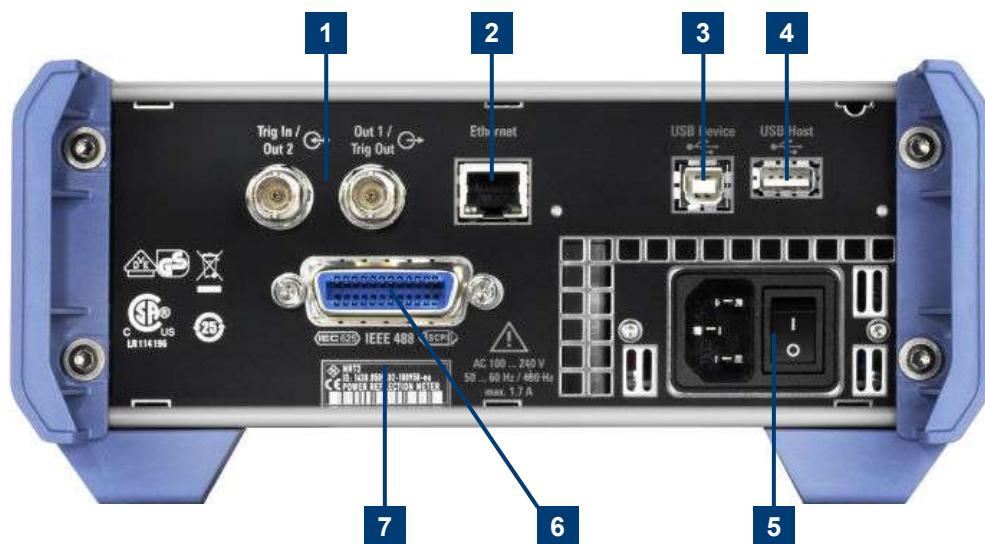

Figure 3-3: Rear panel of the R&S NRT2

- 1 = Trig In / Out 2 and Out 1 / Trig Out connectors, see [Chapter 3.2.2.1, "Trig In / Out 2 and Out 1 / Trig Out Connectors"](#), on page 25.
- 2 = Ethernet interface, see [Chapter 3.2.2.2, "Ethernet Interface"](#), on page 26.
- 3 = USB device interface, see [Chapter 3.2.2.3, "USB Device Interface"](#), on page 26.
- 4 = USB host interface, see [Chapter 3.2.2.4, "USB Host Interface"](#), on page 26.
- 5 = AC supply and power switch, see [Chapter 3.2.2.5, "AC Supply and Power Switch"](#), on page 26.
- 6 = IEC 625/IEEE 488 interface, see [Chapter 3.2.2.6, "IEC 625/IEEE 488 Interface"](#), on page 26.
- 7 = Name plate, see [Chapter 3.2.2.7, "Name Plate"](#), on page 27

3.2.2.1 Trig In / Out 2 and Out 1 / Trig Out Connectors

See (1) in [Figure 3-3](#).

The Out 1 / Trig Out BNC connectors supply an analog signal with a voltage between 0 V and 2.5 V. It can be used to output a voltage that is proportional to the measured value (e.g. for level regulation) or a digital signal for limit monitoring.

The Trig In / Out 2 BNC connectors can be used either as an external trigger input with a switchable impedance (10 k Ω or 50 Ω) or as a second analog output.

By default, both connectors are disabled.

Further information:

- ["I/O 1, I/O 2 tabs"](#) on page 68

3.2.2.2 Ethernet Interface

See (2) in [Figure 3-3](#).

The Ethernet connector is an RJ45 socket for remote controlling the R&S NRT2 via a network.

3.2.2.3 USB Device Interface

See (3) in [Figure 3-3](#).

USB 2.0 (universal serial bus) interface of the type B (receptacle). Used to connect the R&S NRT2 to a computer for USB remote control.

3.2.2.4 USB Host Interface

See (4) in [Figure 3-3](#).

See [Chapter 3.2.1.4, "USB Host Interface"](#), on page 24.

3.2.2.5 AC Supply and Power Switch

See (5) in [Figure 3-3](#).

Observe the safety instructions in ["Connecting to power"](#) on page 10.

When the R&S NRT2 is connected to the AC supply, it automatically sets itself to the correct range for the applied voltage. The range is printed on the casing. There is no need to set the voltage manually.

Further information:

- [Chapter 3.1.6, "Connecting to Power"](#), on page 18

3.2.2.6 IEC 625/IEEE 488 Interface

See (6) in [Figure 3-3](#).

Requires GPIB/IEEE488 Interface (R&S NRT2-B8).

IEC bus (IEEE 488) interface for remote control of the R&S NRT2. Used to connect a controller to remote control the R&S NRT2. Use a shielded cable for the connection.

Characteristics of the IEC bus (IEEE 488) interface:

- 8-bit parallel data transfer
- Bidirectional data transfer
- Three-wire handshake
- High data transfer rate
- Maximum length of connecting cables 15 m (single connection 2 m)

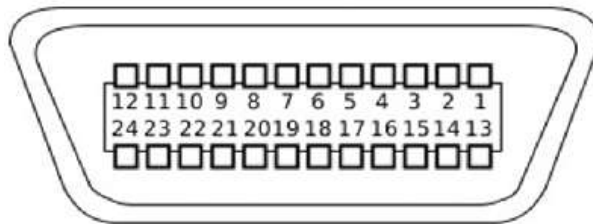

3.2.2.7 Name Plate

See (7) in [Figure 3-3](#).

Shows the type, identification and name of the R&S NRT2. The device ID consists of:

<stock number> - <serial number> - <checksum>

The framed 6 digits in [Figure 3-4](#) are the individual serial number.

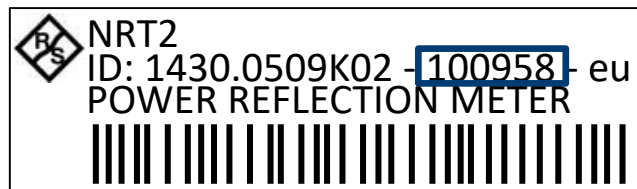

Figure 3-4: Name plate

The name plate also shows the parts of the default hostname. The default hostname consists of <type>-<serial number>.

For the R&S NRT2 with the name plate shown in [Figure 3-4](#), the default hostname is:

NRT2-100958

Further information:

- "[System Info](#)" on page 74
- "[Host Name](#)" on page 63

4 Operating Concepts

- [Manual Operation](#).....28
- [Remote Control](#).....34

4.1 Manual Operation

Using the graphical user interface of the R&S NRT2 and the keys on the front panel, you can easily configure the settings and measure in the provided measurement modes.

Using the touchscreen

A touchscreen allows you to interact with the software using various finger gestures on the screen. The basic gestures supported by the software and most applications are described here. Further actions using the same gestures may be possible.



Tap = touch the screen quickly, usually on a specific element. You can tap most elements on the screen to access the settings belonging to that element (topic).

In graphs, use the following gestures:

- *Pan* = put your fingers on the touchscreen and move them while keeping contact. Thus, you can bring offscreen extensions of the graph into view.
- *Pinch* = move two fingers toward each other to change the zoom.

Going back to a higher hierarchy level

Esc

The [Esc] key is the essential control element to navigate back, for example after you have opened a dialog by tapping an element.

- ▶ Press **Esc** shortly to change to the next-higher hierarchy level.
- ▶ Keep **Esc** pressed to go to the highest hierarchy level, the main measurement dialog.

4.1.1 Main Measurement Dialog

1. Connect a power sensor to the R&S NRT2.
See [Chapter 3.1.8, "Connecting Power Sensors"](#), on page 19.
2. Boot the R&S NRT2.
After successful booting, the R&S NRT2 displays the main measurement dialog.

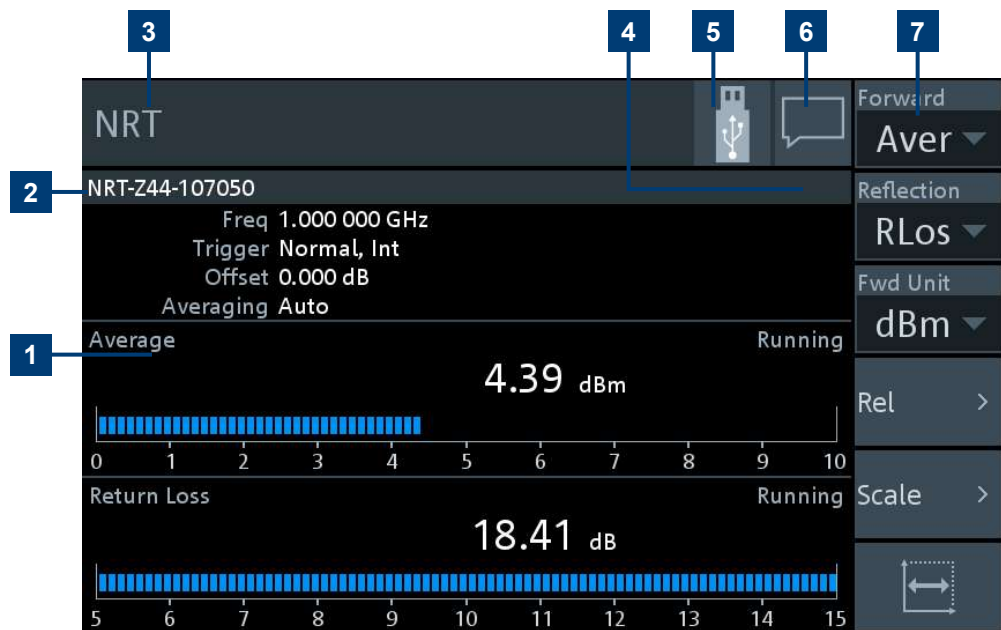

Figure 4-1: Start dialog

- 1 = Measurement pane, see [Chapter 4.1.1.1, "Measurement Pane"](#), on page 29.
- 2 = Connected sensor
- 3 = Title
- 4 = Measurement type
- 5 = Notification center status, see [Chapter 4.1.3, "Notification Center"](#), on page 31.
- 6 = Status information. See [Chapter 4.1.2, "Status Information"](#), on page 30.
- 7 = Navigation pane

The navigation pane gives quick access to important settings.

4.1.1.1 Measurement Pane

In the measurement pane, the settings, results and status of the active measurements are displayed. The measurement pane is divided into touch areas that lead to different settings.

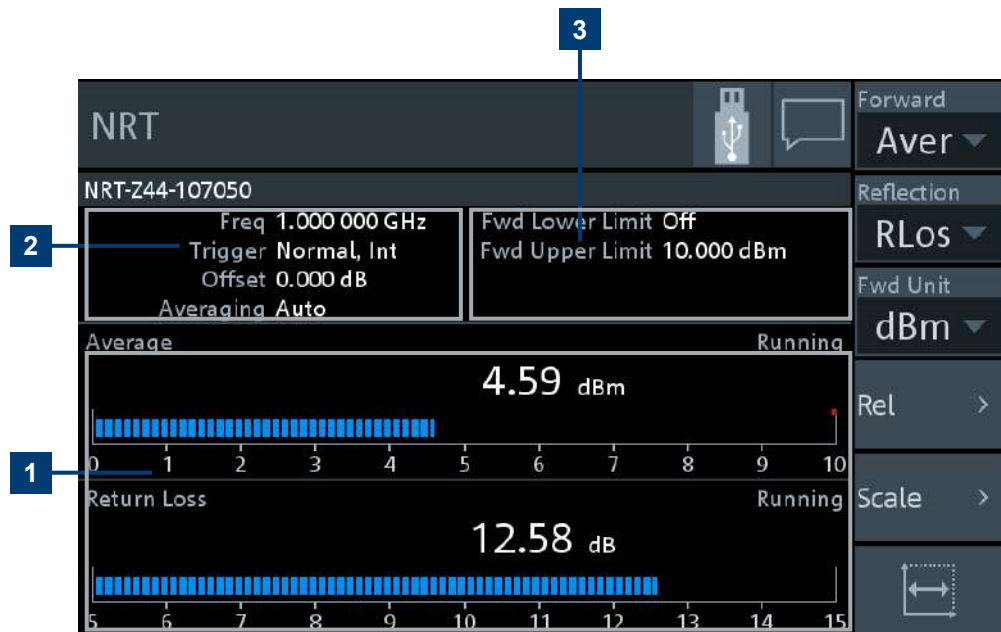

Figure 4-2: Layout of the measurement pane





- 1 = Displayed measurement value or graph
- 2 = Displayed settings
- 3 = Displayed limit values

- ▶ Tap the *displayed settings*, (1) in Figure 4-2, to access the sensor settings. The "Channel Configuration" dialog is displayed. See Chapter 6, "Sensor Configuration", on page 50.
- ▶ Tap the *displayed limit values*, (2) in Figure 4-2, to change limit values. The "Limit Monitor" dialog is displayed. See "Limit Monitor" on page 48.
- ▶ Tap the *displayed measurement value or graph*, (3) in Figure 4-2, to configure the measurement, the display and the sensor. The "Measurement Overview" dialog is displayed. See Chapter 5, "Measurement and Display Configuration", on page 36.

4.1.2 Status Information

The status information is displayed in the upper right corner, left from the notification center. See Figure 4-1.

Table 4-1: Status symbols

Symbol	Description	Further information
	Memory stick is connected and ready for use.	Chapter 3.1.9, "Connecting USB and External Devices" , on page 20
	Memory stick is connected and initialization is in progress. When the moving green dot vanishes, the memory stick is ready for use.	
	R&S NRT2 is in remote control.	Chapter 4.2.2, "Returning to Manual Operation (LOCAL)" , on page 35
	LLO means local lockout. R&S NRT2 is in remote control. Manual operation is disabled.	
	Identification and initialization of a connected power sensor is in progress.	

4.1.3 Notification Center

The notification center collects all information during the operation of the R&S NRT2:



- Notices
- Warning messages
- Error messages



The notification status is displayed in the upper right corner:

- The displayed symbol belongs to the most severe message. For example, if one error and 5 notices are present, the symbol of the error message is displayed. The symbols used are explained in [Table 4-2](#).
- The number of all messages is displayed in the color of the most severe message.

See (5) in [Figure 4-1](#).

Table 4-2: Notification symbols

Symbol	Description
	No message is available.
	Only one or more notices are present.

Symbol	Description
	At least one warning message is present. Yellow is the assigned color.
	At least one error message is present. Red is the assigned color.

To display the messages

- ▶ Tap the notification symbol in the upper left corner.

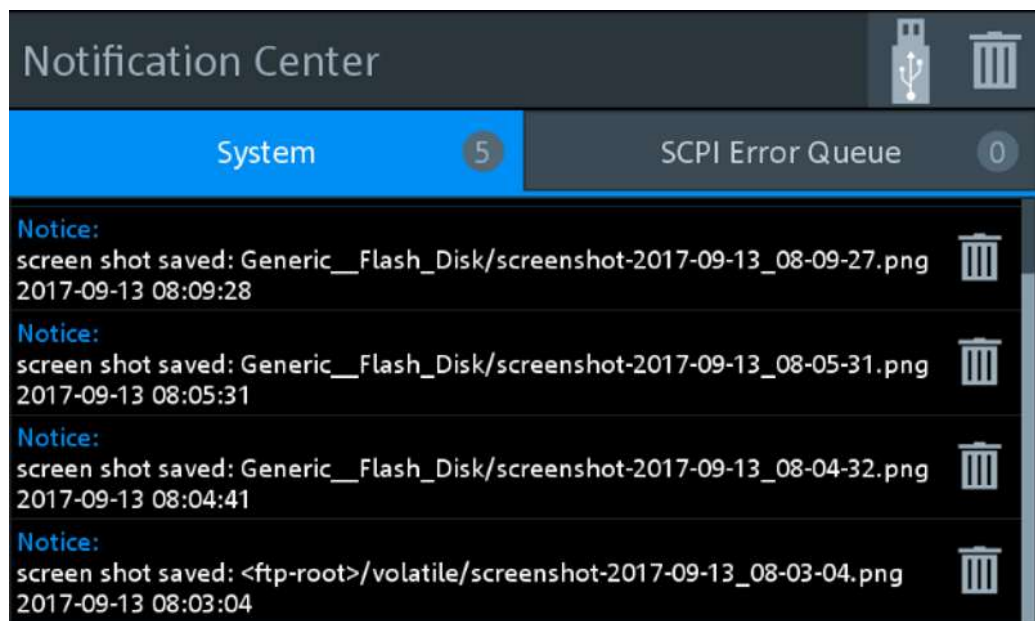

The "Notification Center" dialog has two tabs:

- "System"
All messages concerning the instrument are listed.
- "SCPI Error Queue"
Messages related to the remote command functionality are displayed.

To delete notices no longer needed

- ▶ If you want to delete a specific notice, tap the bin symbol next to the notice.
- ▶ If you want to delete all notices, tap the bin symbol in the right corner.

Further information:

- [Chapter 12.2, "Notifications"](#), on page 189

4.1.4 Editing Parameters

1. Tap a parameter to change its value.
Depending on the selected parameter, a numeric or an alphanumeric editor is displayed.
2. Tap **+ -** to display the value range of the parameter ("Min", "Max").
3. If "More x/x" is displayed, more units are available than displayed. Tap "More x/x" to scroll through the units.
Example: "More 2/4" means, page 2 is displayed, 4 pages are available in total.

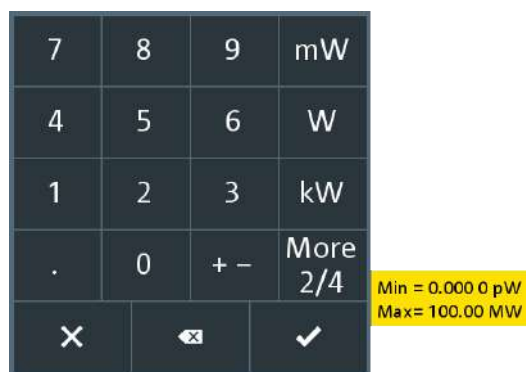

Figure 4-3: Numeric editor (example)

Use the alphanumeric editor as a standard keyboard.



Figure 4-4: Alphanumeric editor

4.1.5 Creating and Saving Screenshots

You can create a screenshot of the current display, for example to save graphical measurement results.

- ▶ Press the [Screenshot] key on the front panel.

The R&S NRT2 saves the screenshot in PNG format.

If a memory stick is connected, the PNG is saved on the memory stick.

Otherwise, the PNG is saved in the volatile directory of the FTP directory. You can download the PNG using FTP.

In the "Notification Center", a "Notice" message shows the file path and name.

Remote control:

[SYSTem:HCOPY](#) on page 175

Further information:

- [Chapter 3.1.9, "Connecting USB and External Devices"](#), on page 20
- [Chapter 3.2.1.4, "USB Host Interface"](#), on page 24

4.2 Remote Control

The R&S NRT2 is equipped with various interfaces for connecting it to a controller for remote control:

- IEC/IEEE bus interface (standard equipment) in line with the standards IEC 60625.1 (IEEE 488.1) and IEC 60625.2 (IEEE 488.2)
- Gigabit Ethernet interface
- USB 2.0 interface for remote control and firmware update

Connectors are installed at the rear of the R&S NRT2. See [Chapter 3.2, "Instrument Tour"](#), on page 22.

The interfaces support the SCPI (standard commands for programmable instruments) standard, version 1999.0 of May 1999. The SCPI standard is based on the IEEE 488.2 standard. It defines a standardized command language for controlling measuring and test instruments with functions beyond the scope of the IEEE 488.2 standard.

For a detailed description of the remote commands, see [Chapter 11, "Remote Control"](#), on page 92.

4.2.1 Switching to Remote Control (REMOTE)

Prerequisites

- A link is established between the controller and the R&S NRT2.
- The R&S NRT2 is configured correctly.

After power-up, the R&S NRT2 is always in manual control mode, "LOCAL". When the R&S NRT2 receives a SCPI command, it switches to remote control irrespective of the selected interface.

4.2.2 Returning to Manual Operation (LOCAL)

If the R&S NRT2 is in remote control, you can display settings using the front-panel keys and the touchscreen, but you cannot change settings. To do that, you have to return to manual operation.

The R&S NRT2 remains in remote control until you perform one of the following actions. Make sure that the R&S NRT2 is free for you to use.

- ▶ Press the [Esc/Local] key. See "[\[Esc\] / Local](#)" on page 23.
If the manual operation was disabled by the `&LLO` command (local lockout) and the [Esc/Local] key does not work, switch the R&S NRT2 off and on again.
- ▶ Send the `>L` command (go to local).
- ▶ Tap the symbol on the touchscreen.
See [Chapter 4.1.2, "Status Information"](#), on page 30.

5 Measurement and Display Configuration

The R&S NRT2 performs power reflection measurements with the R&S NRT-Zxx directional power sensor.

The R&S NRT-Zxx directional power sensor measures the forward and reverse power. The forward power is the power flux from the source to the load.

To observe during the power reflection measurement

- ▶ **CAUTION!** Risk of electric shock and severe skin burns. During the measurement, the RF power flow can be high.

After switching on the RF power, do not touch the RF ports.

Never exceed permissible continuous power that is shown in the diagram on the back of the power sensor.

Further information:

- [Chapter 6, "Sensor Configuration"](#), on page 50
- Setup see [Chapter 3.1.8.1, "NRT Sensor Connector"](#), on page 19.

5.1 Main Measurement Dialog

After successful booting, the R&S NRT2 displays the main measurement dialog. See also [Chapter 4.1.1, "Main Measurement Dialog"](#), on page 28.

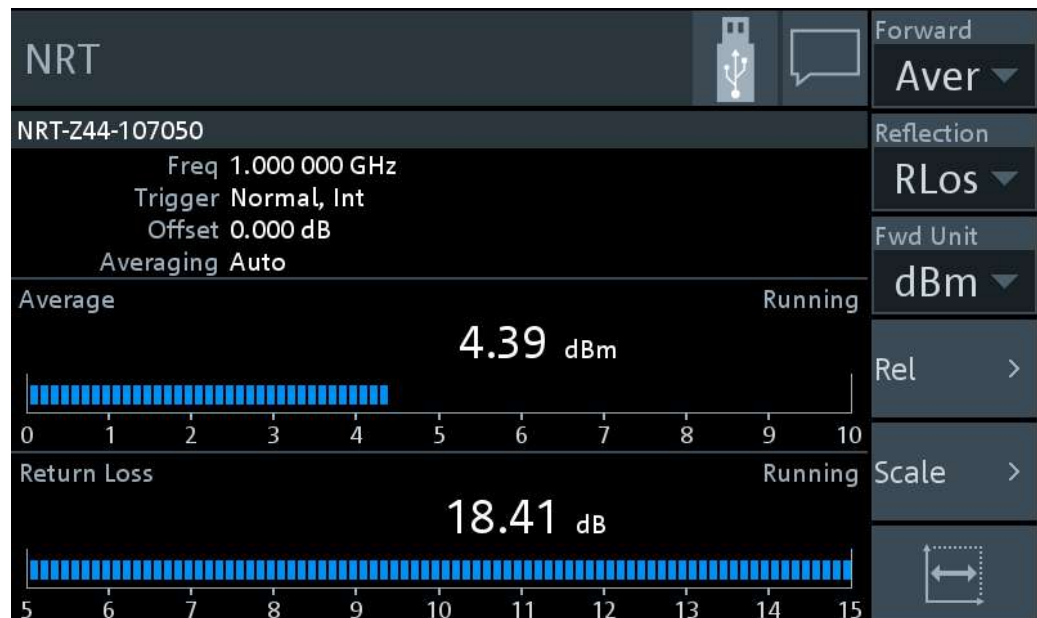

The R&S NRT2 displays the forward and reverse power simultaneously. One scalar value for the selected **Forward** measurement, and one scalar value for the **Reflection** measurement.

Forward.....	37
L Average.....	38
L CCDF.....	38
L Peak Envelope Power (PEP).....	38
L Absorption Average.....	38
L Crest Factor (CF).....	38
L Absorption PEP.....	39
L Burst Average.....	39
L Absorption Burst.....	39
Reflection.....	39
L Off.....	39
L Reverse Power.....	39
L Standing Wave Ratio (SWR).....	40
L Return Loss.....	40
L Reflection Coefficient.....	40
L Reflection Ratio.....	40
Fwd Unit.....	40
Rel.....	40
L Forward Reference Value, Reflection Reference Value.....	41
L Forward Relative State, Reflection Relative State.....	41
Scale.....	41
L Forward Scale Lower Limit, Reflection Scale Lower Limit.....	41
L Forward Scale Upper Limit, Reflection Scale Upper Limit.....	42
Autoscale.....	42

Forward

Opens a dialog to measure power, power differences and envelope parameters.

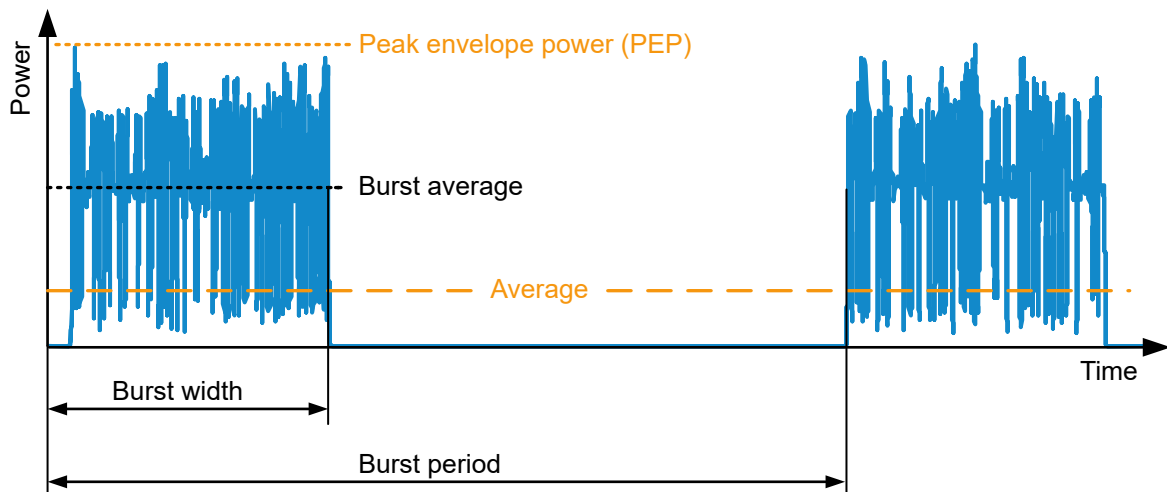

Figure 5-1: Forward power measurement parameters

Average ← Forward

Average power

Remote command:

```
CALCulate<Measurement>[:CHANnel<Channel>]:FEED
"POWer:FORWard:AVERAge"
```

CCDF ← Forward

Complementary cumulative distribution function. Probability that the envelope power is higher than the threshold set under "**CCDF Threshold**" on page 52.

Suitable for assessing the power distribution of spread-spectrum signals, for example CDMA.

Remote command:

```
CALCulate<Measurement>[:CHANnel<Channel>]:FEED
"POWer:FORWard:CCDFunction"
```

Peak Envelope Power (PEP) ← Forward

Peak power of an amplitude-modulated signal. Depending on the selected **Video Bandwidth**, this parameter allows detecting short-time overshoots at the beginning of a burst.

The peak envelope power (PEP) is an important parameter for describing the modulation characteristics of transmitter output stages.

Remote command:

```
CALCulate<Measurement>[:CHANnel<Channel>]:FEED
"POWer:FORWard:PEP"
```

Absorption Average ← Forward

Absorbed average power. Difference between the forward and reverse **Average** measurement.

This parameter measures the effective power transmitted to the load. With good matching, the difference between forward power and absorbed power is less than one percent.

Remote command:

```
CALCulate<Measurement>[:CHANnel<Channel>]:FEED
"POWer:ABSorption:AVERAge"
```

Crest Factor (CF) ← Forward

Level difference between the peak envelope power and the average power in dB.

$$\text{Crest factor} = 10 \text{ dB} \times \log \frac{\text{Peak envelope power}}{\text{Average power}}$$

Allows recognizing larger modulation distortions quickly.

Remote command:

```
CALCulate<Measurement>[:CHANnel<Channel>]:FEED "POWer:CFACTOR"
```

Absorption PEP ← Forward

Absorbed peak envelope power (PEP). Difference of [Peak Envelope Power \(PEP\)](#) between forward and reverse power measurement.

Remote command:

```
CALCulate<Measurement>[:CHANnel<Channel>]:FEED
"POWer:ABSorption:PEP"
```

Burst Average ← Forward

Average power within a burst. The R&S NRT2 determines the average burst power by multiplying the average power with the ratio of burst period to burst width:

$$\text{Burst average} = \text{Average} \frac{\text{Burst period}}{\text{Burst width}}$$

Burst period and burst width are derived depending on the setting of "[Burst Mode](#)" on page 51.

For pulsed RF signals, the burst average defines the average carrier power within the burst. If the burst is unmodulated and has no overshoots, the average burst is equal to the [Peak Envelope Power \(PEP\)](#).

Remote command:

```
CALCulate<Measurement>[:CHANnel<Channel>]:FEED
"POWer:FORWard:AVERage:BURSt"
```

Absorption Burst ← Forward

Absorbed burst average. Difference of [Burst Average](#) between forward and reverse power measurement.

Remote command:

```
CALCulate<Measurement>[:CHANnel<Channel>]:FEED
"POWer:ABSorption:AVERage:BURSt"
```

Reflection

Opens a dialog to measure reflection parameters.

The ratio of forward and reverse power is a measure for the matching of the load that can be expressed as standing wave ratio (SWR), return loss or reflection coefficient.

Off ← Reflection

Disabled.

Remote command:

```
CALCulate<Measurement>[:CHANnel<Channel>]:FEED "POWer:OFF"
```

Reverse Power ← Reflection

Reverse power in W or dBm.

Remote command:

```
CALCulate<Measurement>[:CHANnel<Channel>]:FEED "POWer:REVerse"
```

Standing Wave Ratio (SWR) ← Reflection

$$\text{Standing wave ratio} = \frac{1 + \text{Reflection coefficient}}{1 - \text{Reflection coefficient}}$$

See also "[Reflection Coefficient](#)" on page 40.

Remote command:

```
CALCulate<Measurement>[:CHANnel<Channel>]:FEED "POWer:SWRatio"  
UNIT<Measurement>:POWer:REFlection
```

Return Loss ← Reflection

$$\text{Return loss} = 10 \times \log \frac{\text{Forward power}}{\text{Reverse power}}$$

Remote command:

```
CALCulate<Measurement>[:CHANnel<Channel>]:FEED "POWer:RLOSs"  
UNIT<Measurement>:POWer:REFlection
```

Reflection Coefficient ← Reflection

$$\text{Reflection coefficient} = \sqrt{\frac{\text{Reverse power}}{\text{Forward power}}}$$

Remote command:

```
CALCulate<Measurement>[:CHANnel<Channel>]:FEED  
"POWer:RCoefficient"  
UNIT<Measurement>:POWer:REFlection
```

Reflection Ratio ← Reflection

$$\text{Reflection ratio} = 100 \frac{\text{Reverse power}}{\text{Forward power}}$$

Remote command:

```
CALCulate<Measurement>[:CHANnel<Channel>]:FEED "POWer:RFRatio"  
UNIT<Measurement>:POWer:REFlection
```

Fwd Unit

Sets the unit of the forward power measurement.

"dBm"	Power in dBm
"dBμV"	Power in dBμV
"W"	Power in W

Remote command:

```
UNIT<Measurement>:POWer[:VALue]  
UNIT<Measurement>:POWer:RATio
```

Rel

Groups the settings for relative measurements.

Forward Reference Value, Reflection Reference Value ← Rel

Available if [Forward Relative State](#), [Reflection Relative State](#) is set to "On" or "Set".

Sets the reference value.

Remote command:

```
CALCulate<Measurement>:RELative<DirectionalChannel>:CCDF
CALCulate<Measurement>:RELative<DirectionalChannel>:POWER
CALCulate<Measurement>:RELative<DirectionalChannel>:RATio:
RCOefficient
CALCulate<Measurement>:RELative<DirectionalChannel>:RATio:
RFRatio
CALCulate<Measurement>:RELative<DirectionalChannel>:RATio:RLOSs
CALCulate<Measurement>:RELative<DirectionalChannel>:RATio:SWR
CALCulate<Measurement>:RELative<DirectionalChannel>:RATio[:
VALue]
[SENSe<Sensor>:]POWER:REFerence
```

Forward Relative State, Reflection Relative State ← Rel

Allows you to relate measured power to a reference value.

- | | |
|-----|---|
| Off | Displays the absolute power or power ratio. |
| On | Displays the relative power or power ratio. As reference value, the value specified under Forward Reference Value , Reflection Reference Value is used. |
| Set | Assigns the current measurement result as reference value and displays the relative power. |

Remote command:

```
CALCulate<Measurement>:RELative<DirectionalChannel>[:STATe]
```

Scale

Specifies the scaling of the display.

Forward Scale Lower Limit, Reflection Scale Lower Limit ← Scale

Defines the lower limit of the bargraph display.

Remote command:

```
CALCulate<Measurement>:METer<DirectionalChannel>:LOWer[:DATA]:
CCDF
CALCulate<Measurement>:METer<DirectionalChannel>:LOWer[:DATA]:
RATio:RCOefficient
CALCulate<Measurement>:METer<DirectionalChannel>:LOWer[:DATA]:
RATio:RFRatio
CALCulate<Measurement>:METer<DirectionalChannel>:LOWer[:DATA]:
RATio:RLOSs
CALCulate<Measurement>:METer<DirectionalChannel>:LOWer[:DATA]:
RATio:SWR
```

```
CALCulate<Measurement>:METer<DirectionalChannel>:LOWer[:DATA]:
RATio[:VALue]
CALCulate<Measurement>:METer<DirectionalChannel>:LOWer[:DATA][:
POWER]
```

Forward Scale Upper Limit, Reflection Scale Upper Limit ← Scale

Defines the upper limit of the bargraph display.

Remote command:

```
CALCulate<Measurement>:METer<DirectionalChannel>:UPPer[:DATA]:
CCDF
CALCulate<Measurement>:METer<DirectionalChannel>:UPPer[:DATA]:
RATio:RCoefficient
CALCulate<Measurement>:METer<DirectionalChannel>:UPPer[:DATA]:
RATio:RFRatio
CALCulate<Measurement>:METer<DirectionalChannel>:UPPer[:DATA]:
RATio:RLOSs
CALCulate<Measurement>:METer<DirectionalChannel>:UPPer[:DATA]:
RATio:SWR
CALCulate<Measurement>:METer<DirectionalChannel>:UPPer[:DATA]:
RATio[:VALue]
CALCulate<Measurement>:METer<DirectionalChannel>:UPPer[:DATA][:
POWER]
```



Autoscale

Adapts the scaling of the graphical display.

Remote command:

```
[SENSe<Sensor>:] POWER:REFLection:RANGe:AUTO
[SENSe<Sensor>:] POWER[:POWER]:RANGe:AUTO
```

5.2 Measurement Overview

Access: In the main measurement dialog, tap the *displayed measurement value or graph*. See also [Chapter 4.1.1, "Main Measurement Dialog"](#), on page 28.

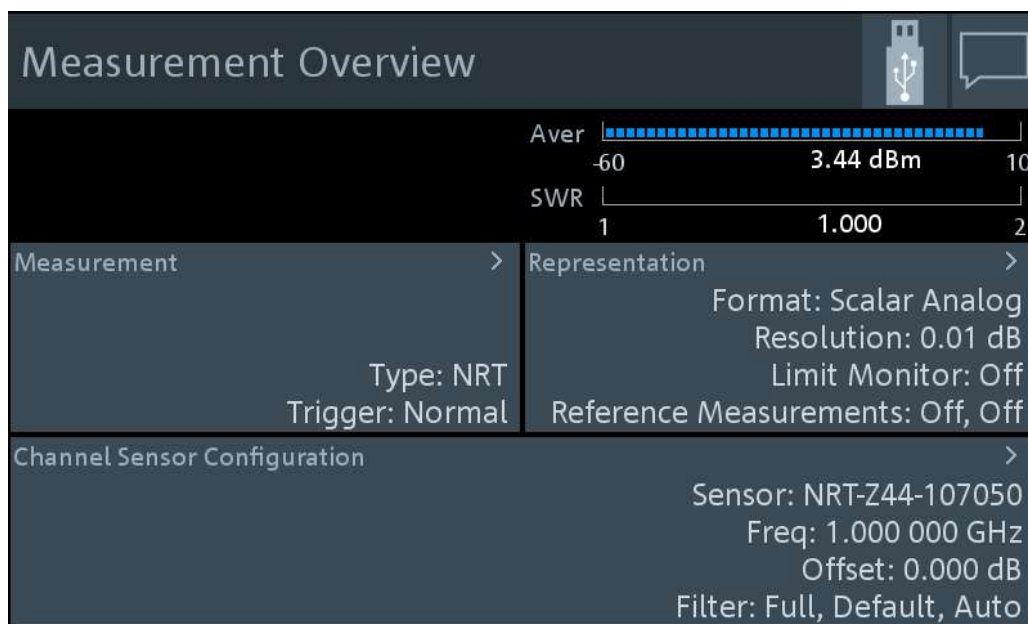

The "Measurement Overview" dialog offers access to all measurement- and sensor-related settings.

Further information:

- [Chapter 5.3, "Measurement Main Configuration Dialog"](#), on page 43
- [Chapter 5.6, "Measurement Representation"](#), on page 46
- [Chapter 6, "Sensor Configuration"](#), on page 50

5.3 Measurement Main Configuration Dialog

Access: "Measurement Overview" > "Measurement"

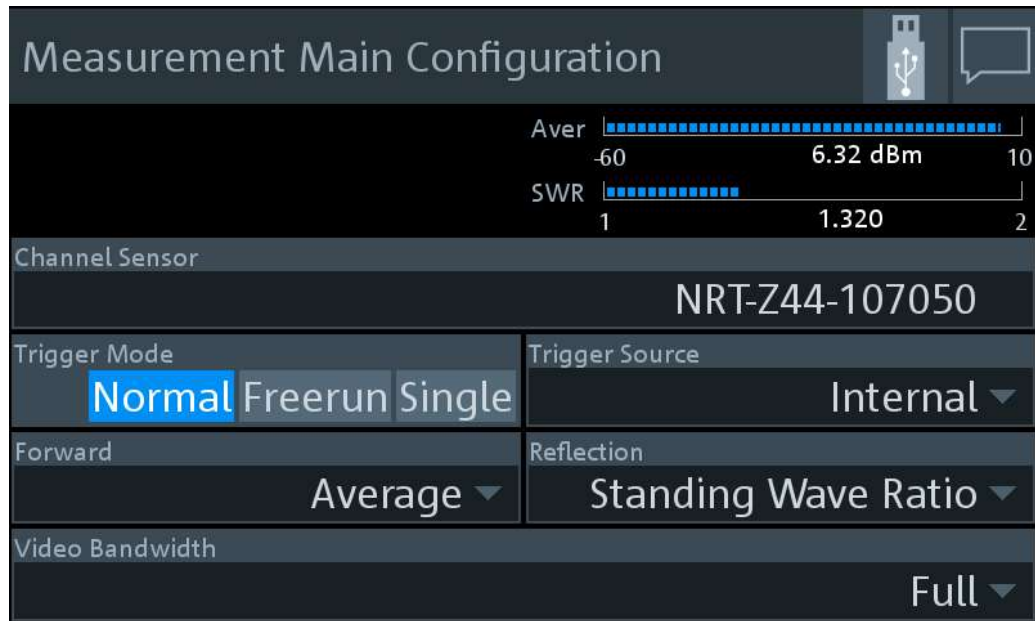

Figure 5-2: Measurement Main Configuration dialog

Channel Sensor

Assigns the power sensor to the measurement.

Trigger Mode

See "[Trigger Mode](#)" on page 46.

Trigger Source

See "[Trigger Source](#)" on page 46.

Forward

See "[Forward](#)" on page 37.

Reflection

See "[Reflection](#)" on page 39.

Video Bandwidth

See "[Video Bandwidth](#)" on page 55.

5.4 Controlling the Measurement

The power sensor offers a bunch of possibilities to control the measurement:

- Do you want to start the measurement immediately after the initiate command or do you want to wait for a trigger event?
- Do you want to start a single measurement cycle or a sequence of measurement cycles?

- Do you want to output each new average value as a measurement result or do you want to bundle more measured values into one result?

Further information:

- [Chapter 5.5, "Triggering"](#), on page 45

5.5 Triggering

In a basic continuous measurement, the measurement is started immediately after the initiate command. However, sometimes you want that the measurement starts only if a specific condition is fulfilled. For example, if a signal level is exceeded, or in certain time intervals. For these cases, you can define a trigger for the measurement.

5.5.1 Trigger States

The power sensor has trigger states to define the exact start and stop time of a measurement and the sequence of a measurement cycle. The following states are defined:

- **Idle**
The power sensor performs no measurement. After powered on, the power sensor is in the idle state.
- **Waiting for trigger**
The power sensor waits for a trigger event that is defined by the trigger source. When the trigger event occurs, the power sensor enters the measuring state.
- **Measuring**
The power sensor is measuring data. It remains in this state during the measurement. When the measurement is completed, it exits this state immediately.

5.5.2 Trigger Sources

The possible trigger conditions and the execution of a trigger depend on the selected trigger mode and trigger source.

If the signal power exceeds or falls below a reference level set by the trigger level, the measurement is started after the defined delay time. Waiting for a trigger event can be skipped.

Trigger source	Description	Remote commands to initiate the measurement
"Internal"	Uses the input signal as trigger signal.	<code>TRIGger<Measurement>[:IMMediate]</code>
"External"	Uses the external trigger signal that is supplied at the Trig In / Out 2 connector. See Chapter 3.2.2.1, "Trig In / Out 2 and Out 1 / Trig Out Connectors" , on page 25.	<code>TRIGger<Measurement>[:IMMediate]</code>

5.5.3 Trigger Settings

Access: "Measurement Overview" > "Measurement" > "Measurement Main Configuration".

See [Chapter 5.3, "Measurement Main Configuration Dialog"](#), on page 43.

Trigger Mode.....	46
Trigger Source.....	46

Trigger Mode

Controls the trigger execution depending on the settings under "[Trigger Source](#)" on page 46.

"Normal"	Continuous triggering with regular trigger events.
"Freerun"	Enables a continuous measurement. The power sensor executes one measurement cycle after the other.
"Single"	Disables continuous triggering so that only one trigger event at a time is executed. To enable triggering again, press [1Trig].

Remote command:

`TRIGger<Measurement>:MODE`

Trigger Source

Sets the source for the trigger event. See [Chapter 5.5.2, "Trigger Sources"](#), on page 45.

Remote command:

`TRIGger<Measurement>:SOURCE`

5.6 Measurement Representation

Access: "Measurement Overview" > "Representation"

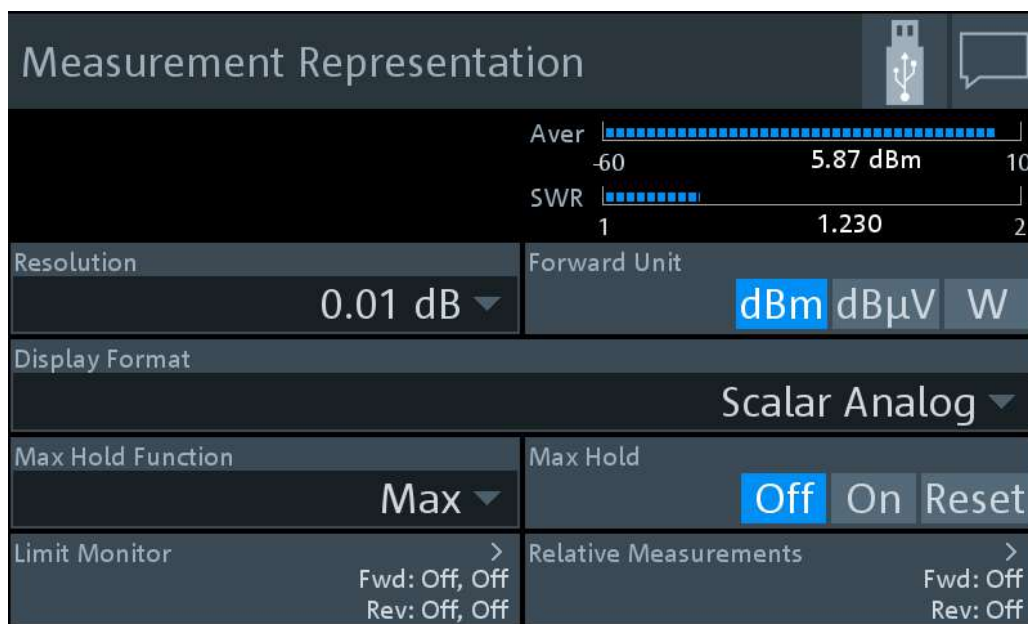

Configures the measurement representation on the display.

Resolution.....	47
Forward Unit.....	47
Display Format.....	47
Max Hold Function.....	48
Max Hold.....	48
Limit Monitor.....	48
L Forward Lower Limit State, Reflection Lower Limit State.....	48
L Forward Lower Limit, Reflection Lower Limit.....	48
L Forward Upper Limit State, Reflection Upper Limit State.....	49
L Forward Upper Limit, Reflection Upper Limit.....	49
Relative Measurements.....	49

Resolution

Configures the resolution of the measurement. For logarithmic power values (dB, dBm or dB μ V), the number of decimal places is set directly. For linear power values (W, $\Delta\%$, 1), the number of decimal places depends on the selected resolution and the magnitude of the result.

"1 dB | 0.1 dB | 0.01 dB | 0.001 dB "

Sets the resolution to the specified value.

Remote command:

```
CALCulate<Measurement>:RESolution
[SENSe<Sensor>:]RRESolution
```

Forward Unit

See "Fwd Unit" on page 40.

Display Format

Sets the display format of the measured values.

"Scalar Digital" Numeric format

"Scalar Analog"

Numeric format with bar chart

Remote command:

`CALCulate<Measurement>:DMODE` on page 110

Max Hold Function

For all measurement functions, the R&S NRT2 stores the maximum and minimum values and the calculated differences between these values.

The selected setting applies to both power and reflection indication. You can change at any time.

"Max" Maximum value

"Min" Minimum value

"Max – Min" Difference between maximum and minimum value

Remote command:

`CALCulate<Measurement>:HOLD:FUNCTION`

Max Hold

If enabled, displays the highest value measured for each point (pixel) of the selected display type.

Remote command:

`CALCulate<Measurement>:HOLD[:STATE]`

Limit Monitor

You can set an upper and a lower limit for the forward and reflection measurement.

Forward Lower Limit State, Reflection Lower Limit State ← Limit Monitor

Enables or disables the monitoring function for the lower limit.

Remote command:

`CALCulate<Measurement>:LIMIT<DirectionalChannel>:LOWER:STATE`

Forward Lower Limit, Reflection Lower Limit ← Limit Monitor

Defines a lower limit.

Remote command:

`CALCulate<Measurement>:LIMIT<DirectionalChannel>:LOWER[:DATA]:`

`CCDF`

`CALCulate<Measurement>:LIMIT<DirectionalChannel>:LOWER[:DATA][:`
`POWER]`

`CALCulate<Measurement>:LIMIT<DirectionalChannel>:LOWER[:DATA]:`
`RATIO:RCoefficient`

`CALCulate<Measurement>:LIMIT<DirectionalChannel>:LOWER[:DATA]:`
`RATIO:RFRatio`

`CALCulate<Measurement>:LIMIT<DirectionalChannel>:LOWER[:DATA]:`
`RATIO:RLOSS`

```
CALCulate<Measurement>:LIMit<DirectionalChannel>:LOWer[:DATA]:
RATio:SWR
CALCulate<Measurement>:LIMit<DirectionalChannel>:LOWer[:DATA]:
RATio[:VALue]
```

Forward Upper Limit State, Reflection Upper Limit State ← Limit Monitor

Enables or disables the monitoring function for the upper limit.

Remote command:

```
CALCulate<Measurement>:LIMit<DirectionalChannel>:UPPer:STATe
```

Forward Upper Limit, Reflection Upper Limit ← Limit Monitor

Defines an upper limit.

Remote command:

```
CALCulate<Measurement>:LIMit<DirectionalChannel>:UPPer[:DATA]:
CCDF
CALCulate<Measurement>:LIMit<DirectionalChannel>:UPPer[:DATA]:
POWER]
CALCulate<Measurement>:LIMit<DirectionalChannel>:UPPer[:DATA]:
RATio:RCoefficient
CALCulate<Measurement>:LIMit<DirectionalChannel>:UPPer[:DATA]:
RATio:RFRatio
CALCulate<Measurement>:LIMit<DirectionalChannel>:UPPer[:DATA]:
RATio:RLOSs
CALCulate<Measurement>:LIMit<DirectionalChannel>:UPPer[:DATA]:
RATio:SWR
CALCulate<Measurement>:LIMit<DirectionalChannel>:UPPer[:DATA]:
RATio[:VALue]
```

Relative Measurements

See "[Rel](#)" on page 40.

6 Sensor Configuration

The "Channel Configuration" dialog offers access to all sensor-related settings.

Access: "Measurement Overview" > "Channel Sensor Configuration"

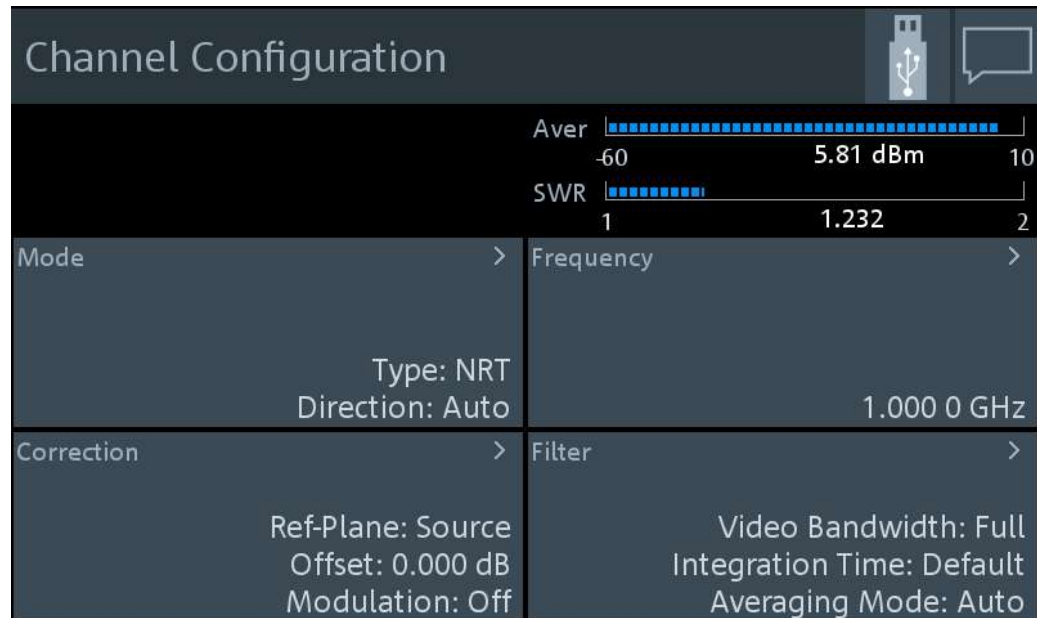

An R&S NRT-Zxx directional power sensor has two measurement channels, one channel for forward power and one channel for reverse power.

Further information:

- [Chapter 5.1, "Main Measurement Dialog"](#), on page 36
- [Mode Settings](#)..... 50
- [Correction Settings](#)..... 52
- [Sensor Frequency](#)..... 54
- [Filter Settings](#)..... 55

6.1 Mode Settings

Access: "Measurement Overview" > "Channel Sensor Configuration" > "Mode"

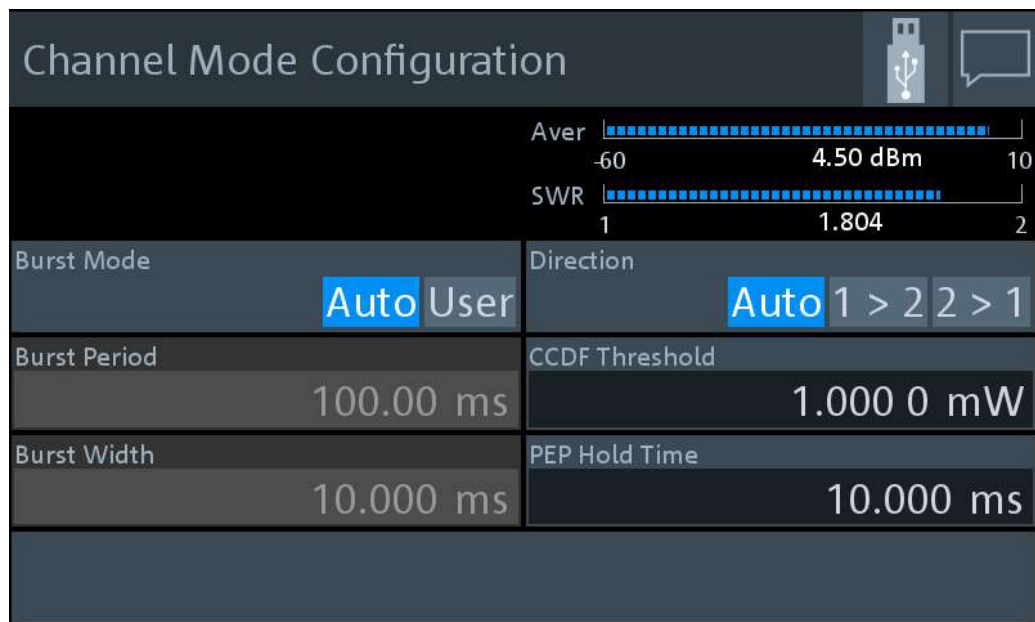

Burst Mode.....	51
Burst Period.....	51
Burst Width.....	51
Direction.....	52
CCDF Threshold.....	52
PEP Hold Time.....	52

Burst Mode

Defines how the average burst power is determined.

- "Auto" Not supported by all power sensors.
The power sensor automatically recognizes the duty cycle of the burst series and calculates the average burst power from this duty cycle and the average power. Set an appropriate [Video Bandwidth](#).
- "User" Define the duty cycle by:
- [Burst Period](#)
 - [Burst Width](#)
- The R&S NRT2 calculates the average burst power from these values.

Remote command:

```
CALCulate<Measurement>[:CHANnel<Channel>]:NRT:BURSt:MODE
```

Burst Period

Available if "User" is set under "[Burst Mode](#)" on page 51.

Sets the burst period.

Remote command:

```
CALCulate<Measurement>[:CHANnel<Channel>]:NRT:BURSt:PERiod
```

Burst Width

Available if "User" is set under "[Burst Mode](#)" on page 51.

Sets the burst width.

Remote command:

```
CALCulate<Measurement>[:CHANnel<Channel>]:NRT:BURSt:WIDTh
```

Direction

Defines how the forward power is determined.

"Auto" Determines the power flow direction automatically. The greater value of two measured values is automatically assigned as forward power.

"1 > 2", "2 > 1" Sets a fixed direction of the forward power, either from port 1 to port 2, or from port 2 to port 1.

The two ports are indicated on the directional power sensor.

Remote command:

```
CALCulate<Measurement>[:CHANnel<Channel>]:NRT:DIRection  
INPut<Sensor>:PORT:SOURce:AUTO  
INPut<Sensor>:PORT:SOURce[:VALue]
```

CCDF Threshold

Sets the threshold for the complementary cumulative distribution function, [CCDF](#).

Remote command:

```
CALCulate<Measurement>[:CHANnel<Channel>]:NRT:CCDF:THReshold
```

PEP Hold Time

Sets the hold time of the peak hold circuit of the power sensor. See also [Peak Envelope Power \(PEP\)](#).

Remote command:

```
CALCulate<Measurement>[:CHANnel<Channel>]:NRT:PEP:HOLD:TIME
```

6.2 Correction Settings

Access: "Measurement Overview" > "Channel Sensor Configuration" > "Correction"

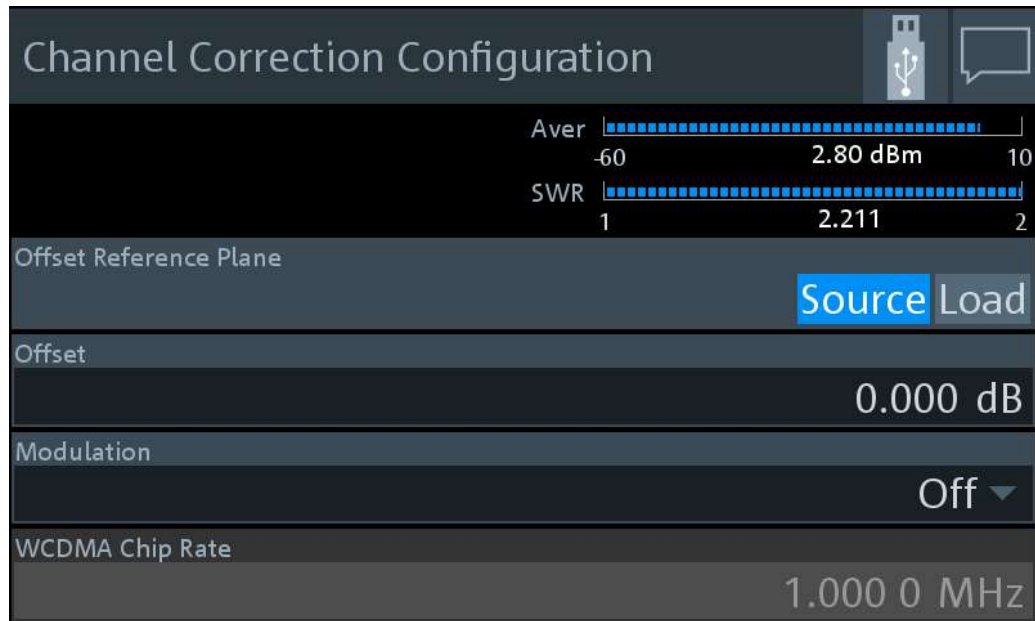

Offset Reference Plane.....	53
Offset.....	53
Modulation.....	53
WCDMA Chip Rate.....	54

Offset Reference Plane

Selects the power sensor port to which the measurement results are referred to.

"Source" Source connector of the R&S NRT-Zxx power sensor

"Load" Load connector of the R&S NRT-Zxx power sensor

Remote command:

```
CALCulate<Measurement>[:CHANnel<Channel>]:CORRection:OFFSet:
RPLane
INPut<Sensor>:PORT:POSition
```

Offset

Considers the transmission loss in a cable that connects the desired measurement point, set by [Offset Reference Plane](#), and the power sensor.

Remote command:

```
CALCulate<Measurement>[:CHANnel<Channel>]:CORRection:OFFSet:
STATe
CALCulate<Measurement>[:CHANnel<Channel>]:CORRection:OFFSet[:
MAGNitude]
INPut<Sensor>:PORT:OFFSet
```

Modulation

Sets a communication standard for the modulation correction to reduce systematic deviations occurring in power measurements.

"Off" Disabled.

"IS95"	IS- 95 CDMA standard for base stations.
"WCDMA"	WCDMA standard for base stations.
"DVB-T"	DVB-T standard for terrestrial DVB TV transmitters.
"DAB"	DAB standard for radio transmitters.

Remote command:

```
CALCulate<Measurement>[:CHANnel<Channel>]:NRT:DMODulation[:
VALue]
[SENSe<Sensor>:]DM:STATe
[SENSe<Sensor>:]DM:STANdard
```

WCDMA Chip Rate

Available if "WCDMA" is set under [Modulation](#).

Sets the chip rate for the WCDMA communication standard.

Remote command:

```
CALCulate<Measurement>[:CHANnel<Channel>]:NRT:DMODulation:WCDMa:
CRATe
```

6.3 Sensor Frequency

Access: "Measurement Overview" > "Channel Sensor Configuration" > "Frequency"

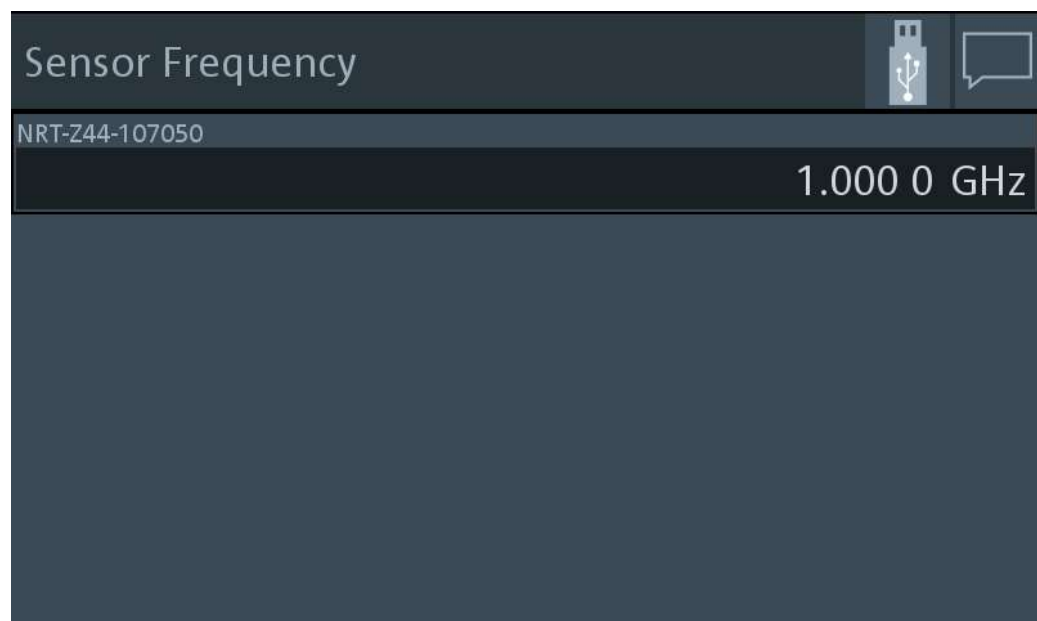

<Sensor name>

Sets the carrier frequency of the applied signal. This value is used for frequency-response correction of the measurement result.

The [\[Freq\]](#) key opens the same dialog.

Remote command:

[SENSe<Sensor>:] FREQuency [:CW] on page 151

6.4 Filter Settings

Access: "Measurement Overview" > "Channel Sensor Configuration" > "Filter"

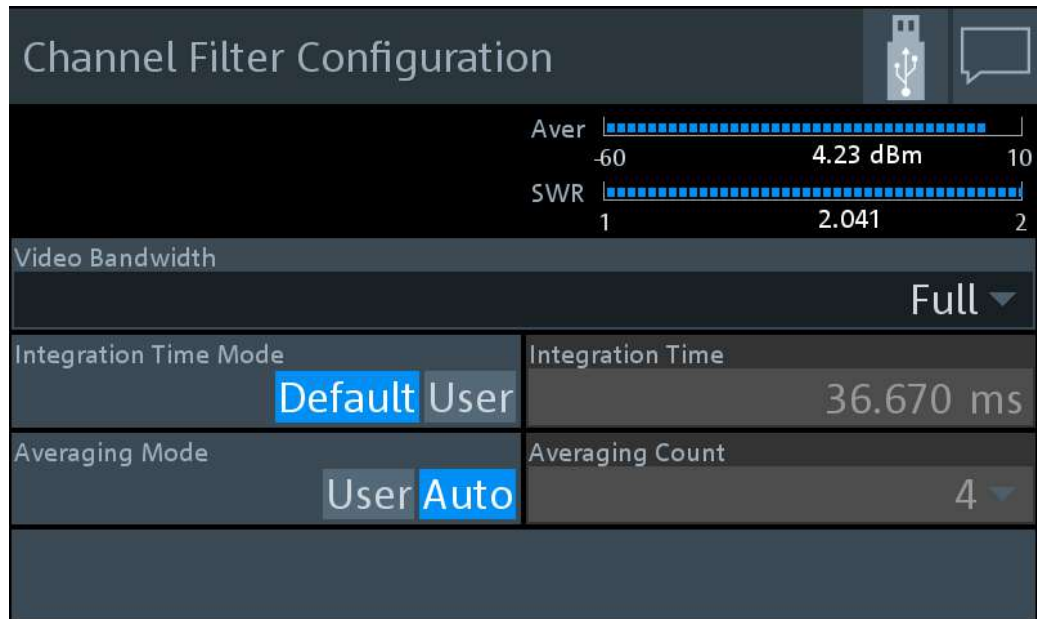

Video Bandwidth.....	55
Integration Time Mode.....	55
Integration Time.....	56
Averaging Mode.....	56
Averaging Count.....	56

Video Bandwidth

For measuring the peak envelope power, specify the video bandwidth that the power sensor uses for measuring the detected RF signal.

"4 kHz" | "200 kHz" | "Full"

"Full" means that the maximum bandwidth of the power sensor is used.

Remote command:

```
CALCulate<Measurement>[:CHANnel<Channel>]:NRT:VBWidth[:VALue]
[SENSe<Sensor>:]BANDwidth:VIDeo:FNUMBER
[SENSe<Sensor>:]BWIDth:VIDeo:FNUMBER
```

Integration Time Mode

Specifies which integration time is used for a single measurement.

"Default" Uses the default settings.

"User" Define a value under [Integration Time](#).

Remote command:

```
CALCulate<Measurement>[:CHANnel<Channel>]:NRT:APERture:MODE
```

Integration Time

Available if [Integration Time Mode](#) is set to "User".

Defines the integration time for a single measurement.

Remote command:

```
CALCulate<Measurement>[:CHANnel<Channel>]:NRT:APERture[:VALue]
```

Averaging Mode

Sets the averaging mode.

"User" Define the value under [Averaging Count](#).

"Auto" Determines the average count automatically from the level of the input signal.

Remote command:

```
CALCulate<Measurement>[:CHANnel<Channel>]:AVERage:COUNT:AUTO[:STATE]
```

Averaging Count

Available if [Averaging Mode](#) is set to "User".

Sets the number of readings that are averaged for one measured value. The higher the count, the lower the noise, and the longer it takes to obtain a measured value.

Remote command:

```
CALCulate<Measurement>[:CHANnel<Channel>]:AVERage:COUNT[:VALue]
```

7 Saving and Recalling Settings

When shutting down, the R&S NRT2 saves the measurement settings. When booting the next time, the R&S NRT2 uses the settings from the last session. See also [Chapter 3.1.10, "Switching On or Off"](#), on page 21.

If you want to return to a defined initial state, perform a preset. See "[Preset](#)" on page 58.

If you want to save specific measurement settings to reuse at another time, save the setup in a file. The R&S NRT2 offers 20 setup files for this purpose.

Access: [Preset] > "Save / Recall / Preset" dialog

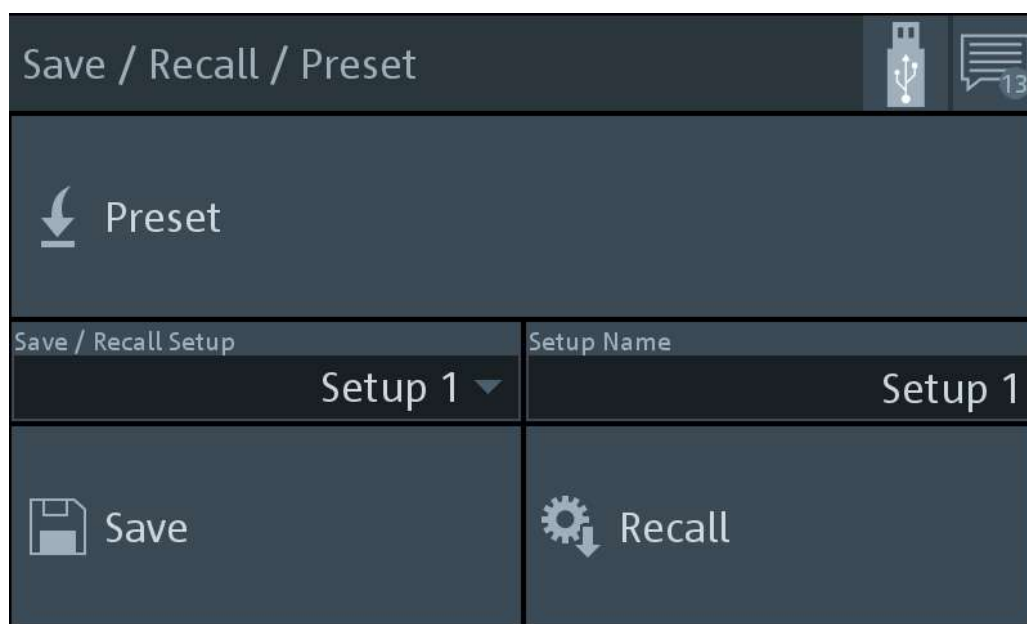

Figure 7-1: Save / Recall / Preset dialog

To save settings

1. Press [Preset].
2. Under "Save / Recall Setup", select a setup, for example "Setup 2".
3. If you want to give the setup a meaningful name, enter a new name under "Setup Name".
4. Tap "Save".

To recall settings

1. Press [Preset].
2. Under "Save / Recall Setup", select the setup you want to load, for example "Setup 2".

3. Tap "Recall".

Preset.....	58
Save / Recall Setup.....	58
Save.....	58
Setup Name.....	58
Recall.....	58

Preset

Sets the R&S NRT2 and the connected R&S power sensors to a defined initial state. Thus, you can change parameter values from a well defined starting point.

For details on sensor settings, see the user manual of the R&S power sensor.

Remote command:

*RST

Save / Recall Setup

Selects the setup file in which the instrument settings are saved.

Save

Saves the current instrument settings in the selected setup file.

Remote command:

*SAV

Setup Name

Selects the setup file from which to load the instrument settings.

Recall

Restores the selected instrument settings.

Remote command:

*RCL

8 Zeroing Sensors

Zeroing removes offset voltages from the analog circuitry of the sensors, so that there are only low powers displayed when there is no power applied.

Zeroing is recommended if:

- The temperature has varied by more than 5 K.
- The sensor has been replaced.
- No zeroing was performed in the last 24 hours.
- Signals of very low power are to be measured, for instance, if the expected measured value is less than 10 dB above the lower measurement range limit.

Access: [Zero] > "Zeroing Sensors" dialog

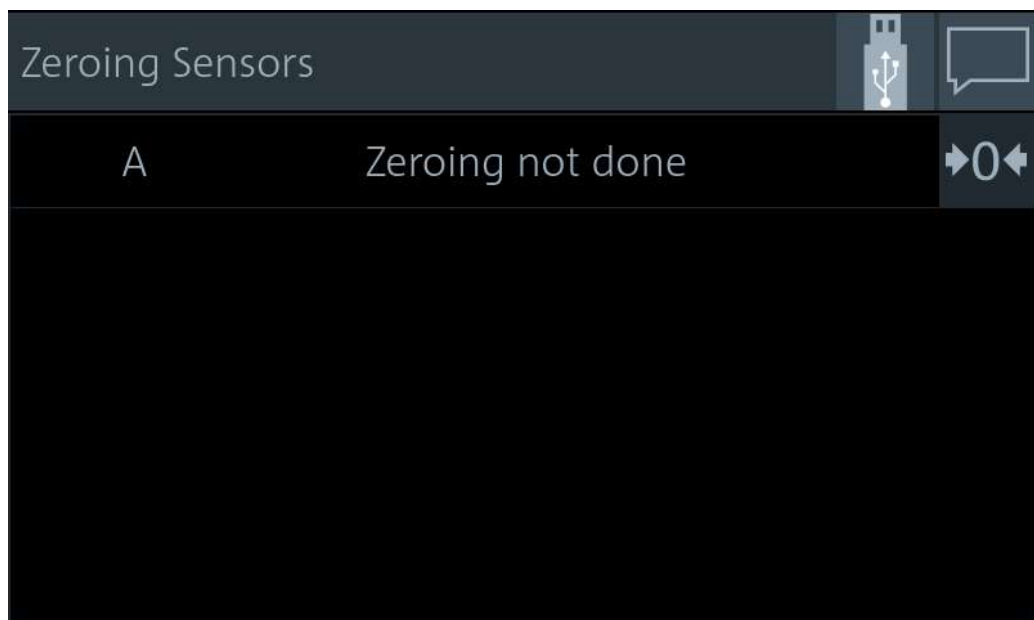

Figure 8-1: Zeroing Sensors dialog

Shows the zeroing status for sensor A: not done, in progress or successful.

Sensors zeroed successful are also checked:

To zero sensors

1. Disconnect the sensors you want to zero from all power sources. Any signal present at the RF input of a sensor is taken into account. You can either switch off the RF output of a DUT or disconnect the sensor physically from any power source.

Note: An active test signal during zeroing causes an error.

2. Press [Zero].
3. Tap

The status changes from in progress to successful.

Remote command:

- `CALibration<Sensor>:ZERO`

9 System Settings

The system settings do not affect the measurements directly.

Access: [System]

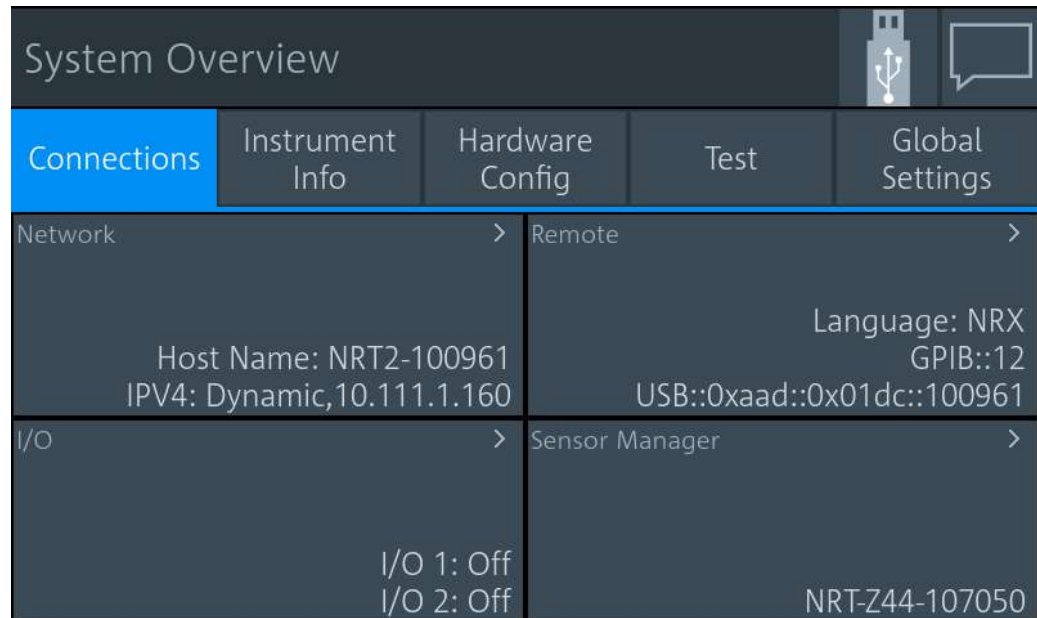

Figure 9-1: System Overview dialog

The "System Overview" dialog is divided into the following tabs:

• Connections	61
• Instrument Info	73
• Hardware Configuration	81
• Test	82
• Global Settings	83

9.1 Connections

Access: [System] > "Connections"

See [Figure 9-1](#).

On this tab, you display and configure the following settings:

• Network Settings	62
• Remote Settings	65
• Input/Output Settings (I/O)	68
• Sensor Manager	70

9.1.1 Network Settings

Access: [System] > "Connections" > "Network"

Contains the settings for integrating the R&S NRT2 in a network. There are two methods to establish a network connection between R&S NRT2 and computer:

- ▶ Connect both to a common network (infrastructure network).
- ▶ Connect R&S NRT2 and computer only over the switch (peer-to-peer network).
In this case, the use of a static IP address is recommended.

Connection errors can affect the entire network. If your network does not support DHCP, or if you choose to disable dynamic TCP/IP configuration, assign a valid address information before connecting the R&S NRT2 to the LAN. Contact your network administrator to obtain valid IP addresses.

After integrating the R&S NRT2 into a network, you can set up the following connections:

- Remote control connection to control the R&S NRT2 using SCPI commands.
See [Chapter 4.2, "Remote Control"](#), on page 34.

The "Network" dialog is divided into the following tabs:

Overview tab.....	63
L Host Name.....	63
L IP Address.....	63
L Default Gateway.....	64
L DNS Server.....	64
IPv4 tab.....	64
L Address Mode.....	64
L DNS Suffix.....	64
L IPv4 Address.....	65
L Subnet Mask.....	65
L Default Gateway.....	65
L DNS Server.....	65

Overview tab

Network	
Overview	IPv4
Host Name	NRT2-100961
IP Address	Dynamic, 10.111.1.160
Default Gateway	10.111.0.1
DNS Server	10.0.2.166

Apart from the [Host Name](#), the other parameters are only displayed here. Configure them on the ["IPv4 tab"](#) on page 64.

Host Name ← Overview tab

Sets the individual hostname of the R&S NRT2.

In a LAN that uses a domain name system server (DNS server), you can access each connected instrument using a unique hostname instead of its IP address. The DNS server translates the hostname to the IP address. Using a hostname is especially useful if a DHCP server is used, as a new IP address can be assigned each time the R&S NRT2 is restarted.

For the default hostname, see [Chapter 3.2.2.7, "Name Plate"](#), on page 27.

When you change the hostname, the R&S NRT2 restarts its connection to the network, which can take several seconds. During this time, you cannot address the R&S NRT2. After the restart, you can only address the R&S NRT2 using the newly set hostname.

Note: It is recommended that you do not change the default hostname to avoid problems with the network connection. However, if you change the hostname, be sure to use a unique name.

Remote command:

```
SYSTem:COMMunicate:NETWork[:COMMon]:HOSTName
```

IP Address ← Overview tab

Displays the IP address, and whether it is static or dynamic.

Set the parameters under:

- ["Address Mode"](#) on page 64
- ["IPv4 Address"](#) on page 65

Default Gateway ← Overview tab

Displays the IP address of the default gateway of the local subnet. Set the parameter under "[Default Gateway](#)" on page 65.

DNS Server ← Overview tab

Displays the IP address of the DNS server of the local subnet. Set the parameter under "[DNS Server](#)" on page 65.

IPv4 tab

Network	
Overview	IPv4
Address Mode	DNS Suffix
Dynamic Static	rsint.net
IPv4 Address	
10.124.2.11	
Subnet Mask	Default Gateway
255.255.252.0	10.124.0.1
DNS Server	
10.0.2.166	

Addresses consist of 4 number blocks separated by dots. In maximum, each block contains 3 digits, for example *100.100.100.100*. Fewer digits in a block are also allowed.

Address Mode ← IPv4 tab

Sets how the IP address is assigned.

"Dynamic" Assigns the IP address automatically, provided the network supports the dynamic host configuration protocol (DHCP).

"Static" Enables assigning the IP address manually.

Remote command:

```
SYSTEM:COMMunicate:NETWork[:IPAddress]:MODE
```

```
SYSTEM:COMMunicate:INET[:SELF]:MODE
```

DNS Suffix ← IPv4 tab

Sets the primary DNS suffix, that means the domain name. DNS uses the suffix for registration and name resolution to identify the R&S NRT2 uniquely in the entire network.

Remote command:

```
SYSTEM:COMMunicate:NETWork[:COMMON]:DOMAIN
```

```
SYSTEM:COMMunicate:INET[:SELF]:DNS:SUFFIX
```

IPv4 Address ← IPv4 tab

Available if "Static" is set under [Address Mode](#).

Sets the IP address of the R&S NRT2.

Remote command:

```
SYSTem:COMMunicate:NETWork[:IPAddress][:Address]
SYSTem:COMMunicate:INET[:SELF]:ADDRESS
```

Subnet Mask ← IPv4 tab

Available if "Static" is set under [Address Mode](#).

Sets the subnet mask of your local subnet.

Remote command:

```
SYSTem:COMMunicate:NETWork[:IPAddress]:SUBNet:MASK
SYSTem:COMMunicate:INET[:SELF]:SUBNetmask:ADDRESS
```

Default Gateway ← IPv4 tab

Available if "Static" is set under [Address Mode](#).

Sets the IP address of the default gateway.

Remote command:

```
SYSTem:COMMunicate:NETWork[:IPAddress]:GATeway
SYSTem:COMMunicate:INET[:SELF]:GATeway:ADDRESS
```

DNS Server ← IPv4 tab

Available if "Static" is set under [Address Mode](#).

Sets the DNS server address of your local subnet.

Remote command:

```
SYSTem:COMMunicate:NETWork[:IPAddress]:DNS
SYSTem:COMMunicate:INET[:SELF]:DNS:ADDRESS
```

9.1.2 Remote Settings

Access: [System] > "Connections" > "Remote"

Contains the settings for remote control.

The "Remote" dialog is divided into the following tabs:

VISA Resource tab.....	66
L Interface - VISA Resource table.....	66
Settings tab.....	66
L GPIB Address.....	67
Emulations tab.....	67
L Language.....	67
L Customization of *IDN?.....	67
L Customization of *OPT?.....	67
L Custom IDN String.....	68
L Custom OPT String.....	68

VISA Resource tab

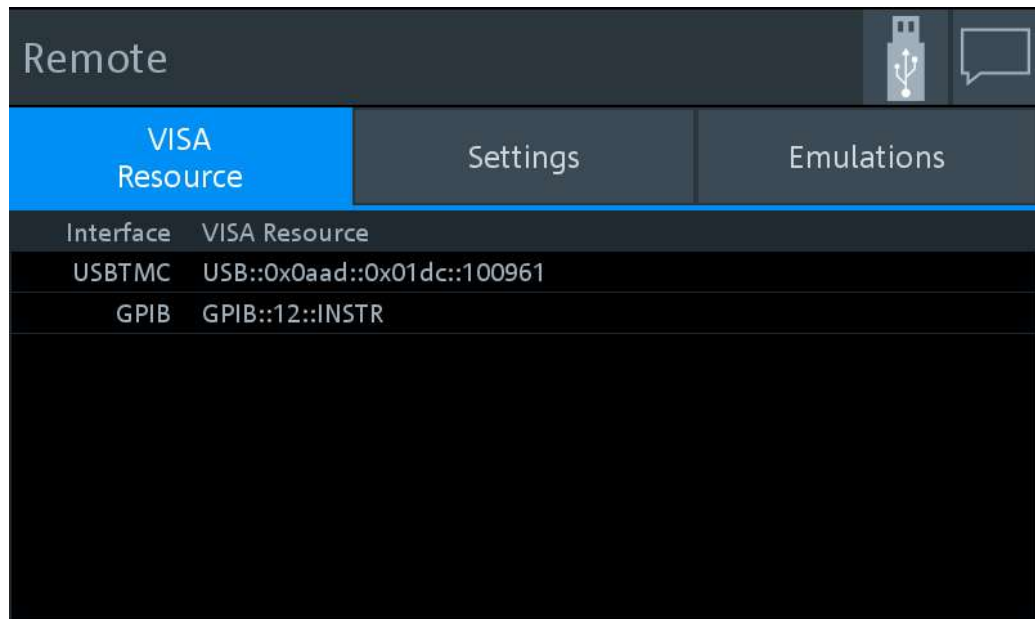

Interface - VISA Resource table ← VISA Resource tab

Displays the VISA resource strings of the interfaces available for remote control.

In a LAN, the VISA resource string is required to establish a communication session between the controller and the R&S NRT2. The resource string is a unique identifier, composed of the specific IP address of the instrument and some network and VISA-specific keywords. The resource string depends on the interface used for remote control.

Settings tab

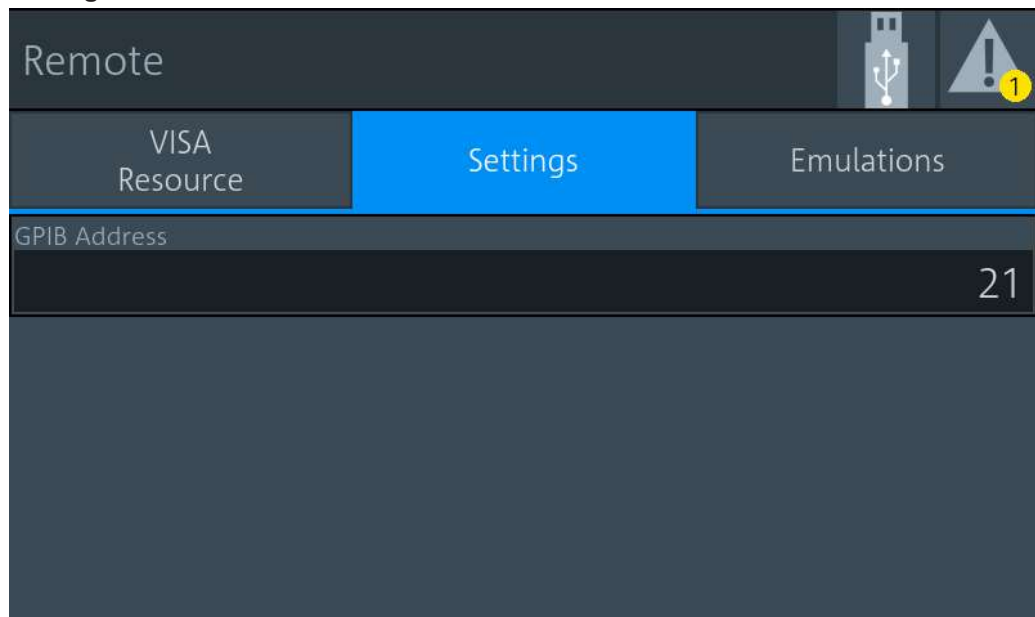

GPIB Address ← Settings tab

Sets the GPIB address.

"1" to "30" Channel address

Remote command:

`SYSTem:COMMunicate:GPIB[:SELF]:ADDRess`

Emulations tab
Language ← Emulations tab

Fixed value.

"SCPI" Native remote command set of the R&S NRT2, based on the standard commands for programmable instruments (SCPI-99).

Customization of *IDN? ← Emulations tab

Sets which identification string is used.

"Off" Default identification string

"User" Customized identification string. Enter the customized instrument identification string under [Custom IDN String](#).

Remote command:

`SYSTem:IDN:MODE`

`SYSTem:IDN:AUTO`

Customization of *OPT? ← Emulations tab

Sets which option string is used.

"Off" Default option string

"User" Customized option string. Enter the customized option string under [Custom OPT String](#).

Remote command:

`SYSTem:OPT:MODE`

`SYSTem:OPT:AUTO`

Custom IDN String ← Emulations tab

Available if [Customization of *IDN?](#) is set to "User".

Sets the customized instrument identification string so that you can identify each R&S NRT2 individually.

Remote command:

`SYSTem:IDN:ANSWer`

Custom OPT String ← Emulations tab

Available if [Customization of *OPT?](#) is set to "User".

Sets the customized option identification string.

Remote command:

`SYSTem:OPT:ANSWer`

9.1.3 Input/Output Settings (I/O)

Access: [System] > "Connections" > "I/O"

The "I/O" dialog is divided into the following tabs:

I/O 1, I/O 2 tabs.....	68
L Mode.....	69
L 0 V Equivalent.....	69
L 2.5 V Equivalent.....	70
L Fail Voltage.....	70

I/O 1, I/O 2 tabs

Configures the two multifunctional BNC connectors at the rear of the R&S NRT2, see [Chapter 3.2.2.1, "Trig In / Out 2 and Out 1 / Trig Out Connectors"](#), on page 25.

- Use the "I/O 1" tab for Out 1 / Trig Out connector.
- Use the "I/O 2" tab for Trig In / Out 2 connector.

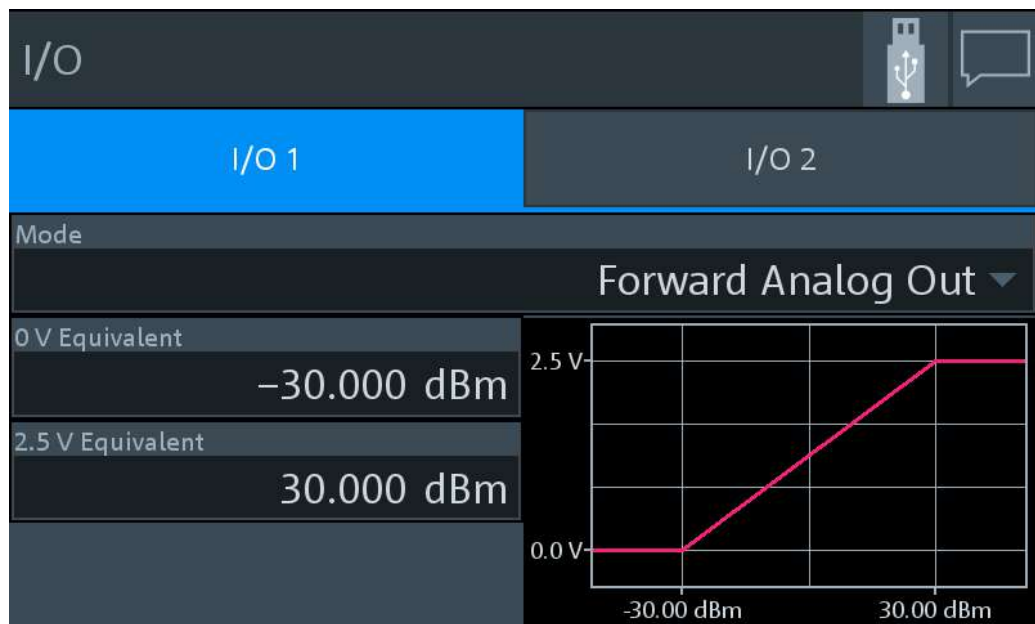

Figure 9-2: Example

Mode ← I/O 1, I/O 2 tabs

Sets the functionality of the Out 1 / Trig Out and Trig In / Out 2 connectors.

"Off" Disables the connector.

"Forw Analog Out", "Refl Analog Out"

Provides an analog voltage that is proportional to the displayed value.

"Forw Limit Violation"

Available for:

- Out 1 / Trig Out BNC connector ("I/O 1" tab)

Sets the fail voltage that is output if a value of the forward measurement causes a limit violation.

"Refl Limit Violation"

Available for the Out 1 / Trig Out BNC connector ("I/O 1" tab).

Sets the fail voltage that is output if a value of the reflection measurement causes a limit violation.

Remote command:

```
[SENSE<Sensor>:]POWER:REFLECTION:RANGE:LIMIT[:STATE]
[SENSE<Sensor>:]POWER[:POWER]:RANGE:LIMIT[:STATE]
OUTPut:MODE<output>
```

0 V Equivalent ← I/O 1, I/O 2 tabs

Available if **Mode** is set to:

- "Forw Analog Out"
- "Refl Analog Out"

Enter the measurement value that corresponds to 0 V output voltage.

Remote command:

```
OUTPut:REcorder<output>:LIMit:LOWer:CCDF
OUTPut:REcorder<output>:LIMit:LOWer[:POWer]
OUTPut:REcorder<output>:LIMit:LOWer:RATio:RCOefficient
OUTPut:REcorder<output>:LIMit:LOWer:RATio:RFRatio
OUTPut:REcorder<output>:LIMit:LOWer:RATio:RLOSS
OUTPut:REcorder<output>:LIMit:LOWer:RATio:SWR
OUTPut:REcorder<output>:LIMit:LOWer:RATio[:VALue]
```

2.5 V Equivalent ← I/O 1, I/O 2 tabs

Available if **Mode** is set to:

- "Forw Analog Out"
- "Refl Analog Out"

Enter the measurement value that corresponds to 2.5 V output voltage.

Remote command:

```
OUTPut:REcorder<output>:LIMit:UPPer:CCDF
OUTPut:REcorder<output>:LIMit:UPPer[:POWer]
OUTPut:REcorder<output>:LIMit:UPPer:RATio:RCOefficient
OUTPut:REcorder<output>:LIMit:UPPer:RATio:RFRatio
OUTPut:REcorder<output>:LIMit:UPPer:RATio:RLOSS
OUTPut:REcorder<output>:LIMit:UPPer:RATio:SWR
OUTPut:REcorder<output>:LIMit:UPPer:RATio[:VALue]
```

Fail Voltage ← I/O 1, I/O 2 tabs

Available if **Mode** is set to:

- "Forw Limit Violation"
- "Refl Limit Violation"

Sets the fail voltage that is output if a measured value causes a limit violation.

"Low"	0 V
"High"	3.3 V

Remote command:

```
[SENSe<Sensor>:]POWer:REFLection:RANGe:AUTO
[SENSe<Sensor>:]POWer:REFLection:RANGe:LIMit:DETECT
OUTPut:LIMit:FAIL
```

9.1.4 Sensor Manager

Access: [System] > "Connections" > "Sensor Manager"

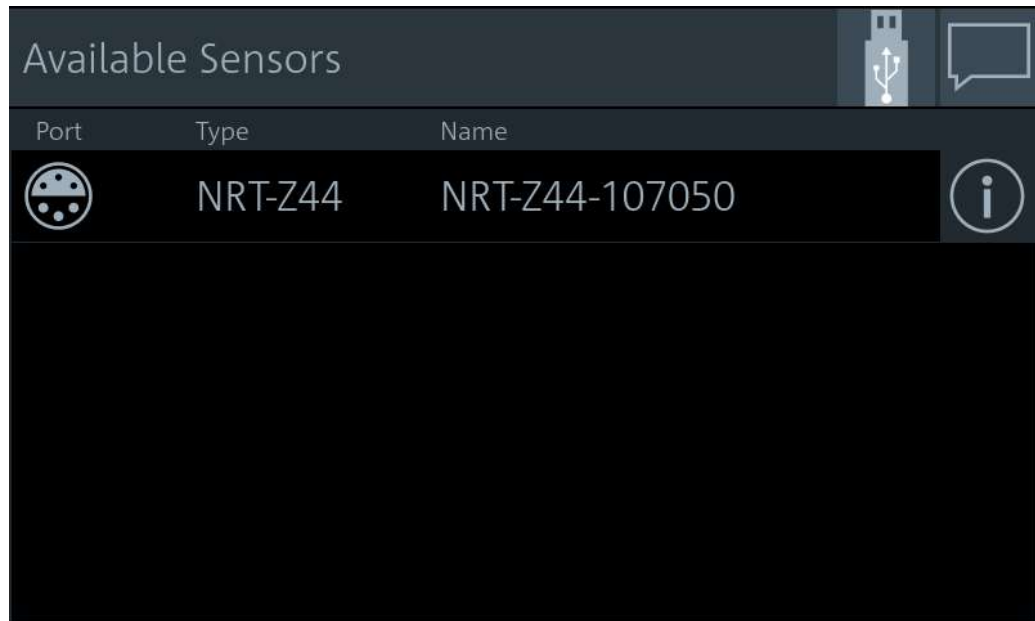

The R&S NRT2 displays the recognized power sensors.

Symbol	Description
	Info icon Tap to open the "Sensor Info" dialog, see " Sensor Info " on page 71.

The sensor manager gives access to:

Sensor Info	71
L Sensor Test	72

Sensor Info

Access: [System] > "Connections" > "Sensor Manager" > 

Displays information about the selected power sensor, including calibration data.

Sensor Info			
Connector	ID	Calibration	2017-02-16
NRT Port	A	Impedance	50
Type	NRT-Z44		
Serial	Firmware Version	Manufacturer	Rohde & Schwarz
107050	V2.02	MaxFreq	4E9
Sensor Name		MaxPower	300
NRT-Z44-107050		MinFreq	25E6
Sensor Test		MinPower	0.03
		SW Build	V2.02
		Serial	107050
		Stock Number	1081.1309.02
		Type	NRT-Z44

Remote command:

[SENSe<Sensor>:] INformation?

Sensor Test ← Sensor Info

Tap "Start Test" to start a selftest of the connected power sensor. The selftest provides detailed information that you can use for troubleshooting.

Sensor Test			
Type	NRT-Z44	HW PARAMETERS:	
Serial	Firmware Version	SUPPLY VOLTAGE +	OK
107050	V2.02	SUPPLY VOLTAGE -	OK
Sensor Name		MH SUPPLY	OK
NRT-Z44-107050		FORW. CONTROL VOLTAGE	OK
Start Test		REFL. CONTROL VOLTAGE	OK
Test Verdict		CCDF OUTPUT LOW	OK
PASS		CCDF OUTPUT HIGH	OK
		CCDF MEDIUM THRESHOLD	OK
		TEMPERATURE	OK
		PERMANENT ERRORS:	
		COMMUNICATION ADC 1	OK
		COMMUNICATION ADC 2	OK
		PEP CIRCUIT OPERATION	OK
		FRAM READ	OK
		FRAM WRITE	OK

"Test Verdict" Shows the status of the selftest.

Remote command:

TEST:SENSoR<Sensor>?

9.2 Instrument Info

Access: [System] > "Instrument Info"

For displaying information on a connected power sensor, see "[Sensor Info](#)" on page 71.

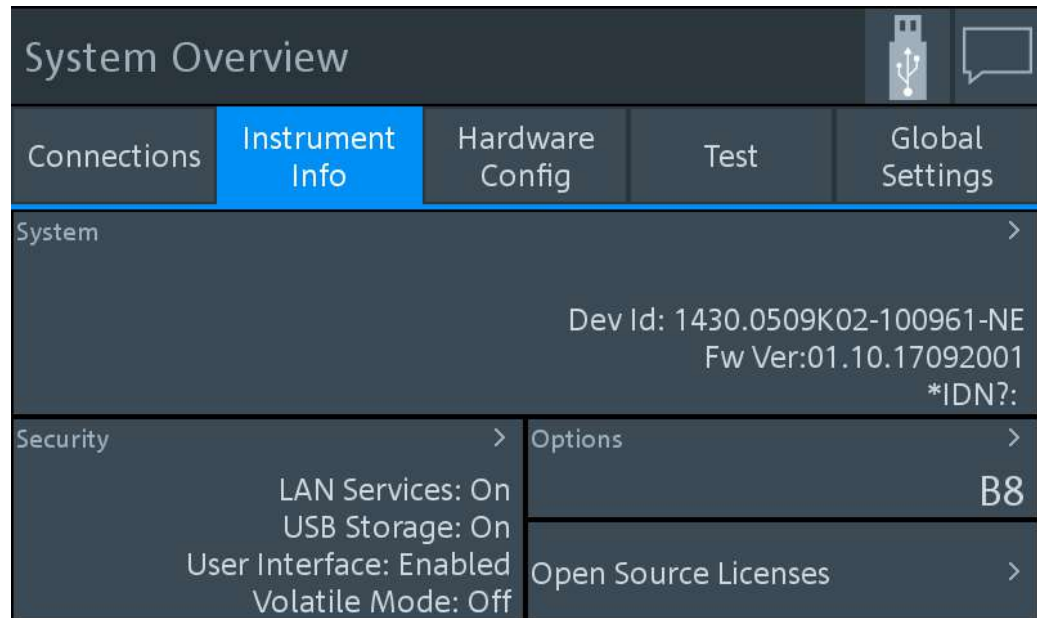

On this tab, you display and configure the following settings:

- [System Info](#)..... 73
- [Security Settings](#)..... 76
- [Option Settings](#)..... 79
- [Open Source Licenses](#)..... 81

9.2.1 System Info

Access: [System] > "Instrument Info" > "System"

Displays a list of instrument-specific parameters.

System Info	
Manufacturer	Rohde&Schwarz
Type	NRT2
Stock Number	1430.0509K02
HW Version	01.00
CPLD Version	2
Serial	100961
Device ID	1430.0509K02-100961-NE
SW Build	01.10.17092001
Options	NRT2-B8
Date and Time Settings >	
2021-08-02 / 17:27:22 / Paris	

System Info.....	74
Date and Time Settings.....	75
L Date.....	75
L Time.....	75
L Time Zone Region.....	75
L Time Zone.....	75

System Info

Displays the information on the R&S NRT2:

- "Manufacturer"
- "Type"
- "Stock Number"
See [Chapter 3.2.2.7, "Name Plate"](#), on page 27.
- "HW Version"
- "CPLD Version"
Complex programmable logic device (CPLD) version
- "Serial"
- "Device ID"
See [Chapter 3.2.2.7, "Name Plate"](#), on page 27.
- "SW Build"
Version of software build
- "Options"
Short names of the installed options
- "MAC Address"
Ethernet hardware address
- "Hostname"
See ["Host Name"](#) on page 63.
- "IP Address"
See ["IP Address"](#) on page 63.
- "**IDN?"

Instrument identification string: <manufacturer>,NRT2,<serial number>,<firmware version>

- **"*OPT?"**
Option identification string; lists the installed options: <option 1>, <option 2>,
- **"Uptime"**
Operating time of the R&S NRT2

Remote command:

`SYSTem:INFO[:INFO]?`

`SYSTem:DID?`

`SYSTem:DEVIce:ID?`

Date and Time Settings

Opens the "Date and Time" dialog.

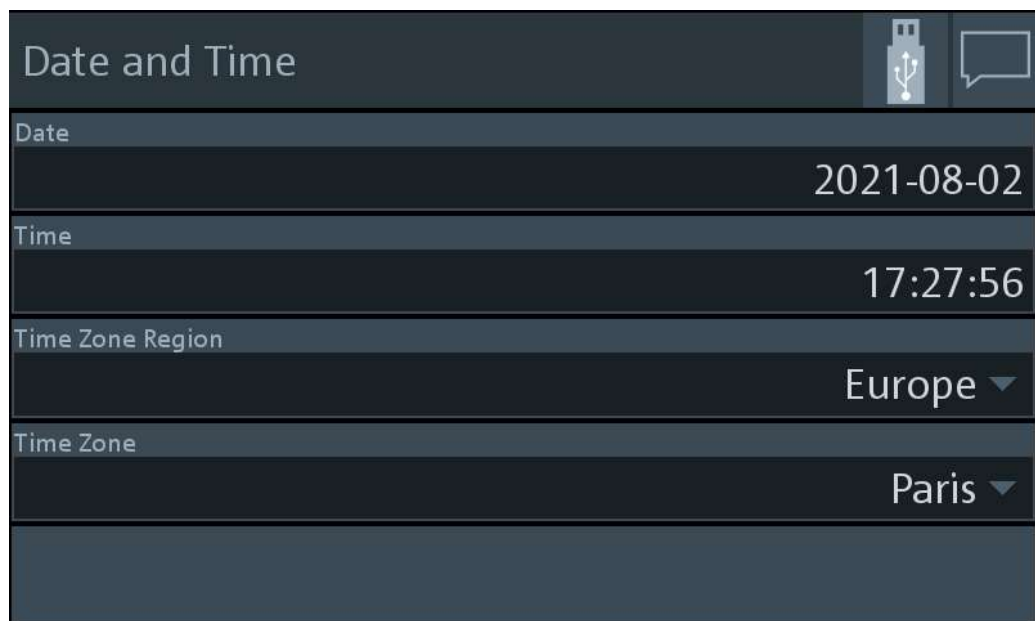

Date ← **Date and Time Settings**

Sets the date in the format YYYY-MM-DD.

Remote command:

`SYSTem:DATE`

Time ← **Date and Time Settings**

Sets the time in the format HH:MM:SS.

Time Zone Region ← **Date and Time Settings**

Sets the time zone region.

Remote command:

`SYSTem:TIME:DSTime:RULE`

`SYSTem:TIME:DSTime:RULE:CATalog?`

Time Zone ← **Date and Time Settings**

Sets the time zone.

Remote command:

SYSTem:TIME:DSTime:RULE

SYSTem:TIME:DSTime:RULE:CATalog?

9.2.2 Security Settings

Access: [System] > "Instrument Info" > "Security"

Contains the settings for access rights, LAN security and passwords.

The "Security" dialog is divided into the following tabs:

General tab.....	76
L Security Password to Unlock Settings.....	77
L USB Storage.....	77
L Volatile Mode.....	77
L User Interface.....	77
LAN Settings tab.....	77
L LAN Services.....	78
L SCPI over LAN.....	78
L Web Server.....	78
L VNC.....	78
L Avahi (Zeroconf).....	78
L SSH.....	78
L Software Update.....	78
Security Password tab.....	78
L Old Password.....	79
L New Password.....	79
L Confirm Password.....	79
L Change Password.....	79

General tab

Configures the access rights for storage devices and restrictions for the user interface.

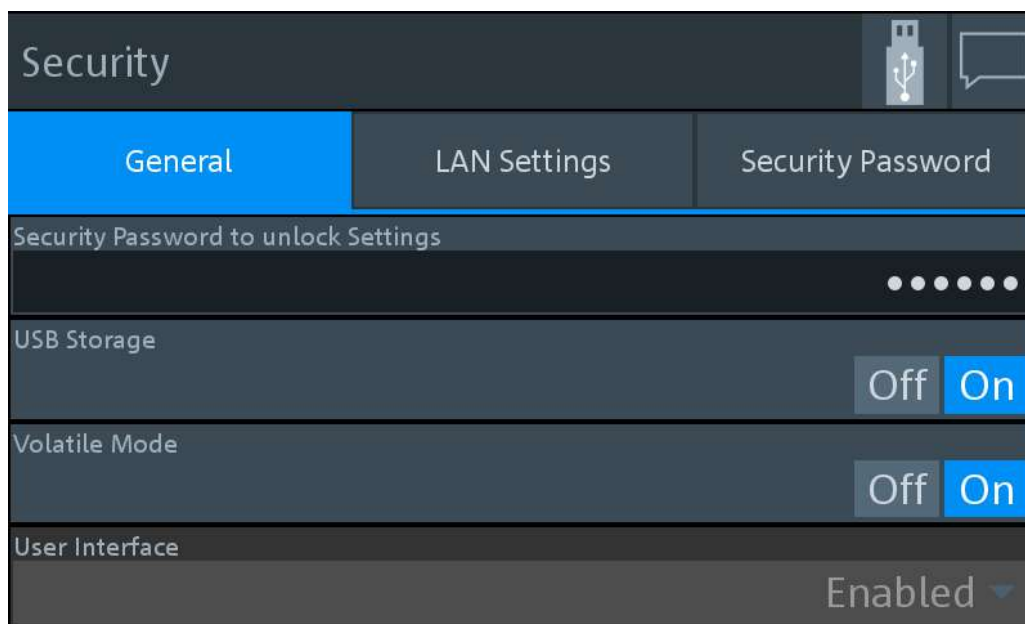

Security Password to Unlock Settings ← General tab

Enter the password that is required to enable the settings protected by a security password. When you leave the "Security" dialog, the settings are disabled automatically.

For preconfigured value and further information, see "[Security Password tab](#)" on page 78.

USB Storage ← General tab

Enables or disables the file transfer via USB storage.

Volatile Mode ← General tab

If enabled, the R&S NRT2 does not save changed settings in the non-volatile memory. After a reboot, the R&S NRT2 has the same configuration as at the time when you enabled the volatile mode.

Use the volatile mode if you want to reboot with a defined configuration for a measurement setup, regardless of any settings made manually or by remote control.

Enabling the volatile mode requires the security password. If you change into the volatile mode or back, a reboot is required.

User Interface ← General tab

Fixed value.

"Enabled" Enables manual operation. The screen and all manual controls are working. Remote operation is also enabled.

LAN Settings tab

Configures the LAN interface in general or all LAN services individually.

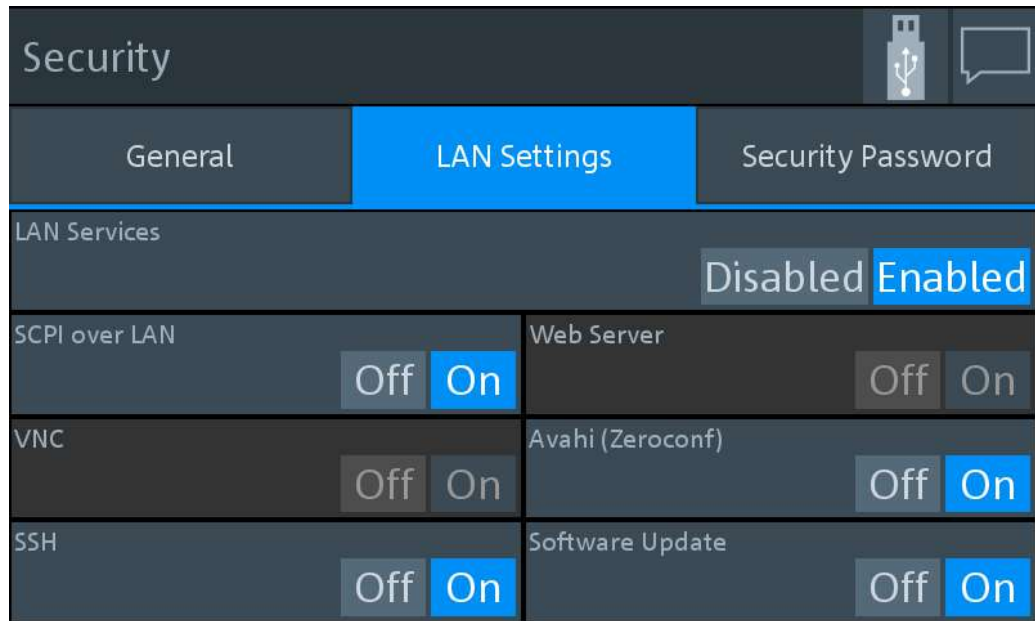
**LAN Services ← LAN Settings tab**

Enables or disables the LAN services in general. If enabled, it provides remote access via all unlocked services.

SCPI over LAN ← LAN Settings tab

Enables or disables the access over LAN to control the R&S NRT2 remotely by using SCPI (standard commands for programmable instruments) commands.

Web Server ← LAN Settings tab

Not implemented.

VNC ← LAN Settings tab

Not implemented.

Avahi (Zeroconf) ← LAN Settings tab

Enables or disables Avahi, a service for automatic configuration of the R&S NRT2 in a network environment.

SSH ← LAN Settings tab

Enables or disables access using a secure shell (SSH), a network protocol for secure data communication.

Software Update ← LAN Settings tab

Enables or disables the software update over LAN.

Security Password tab

Used to change the security password.

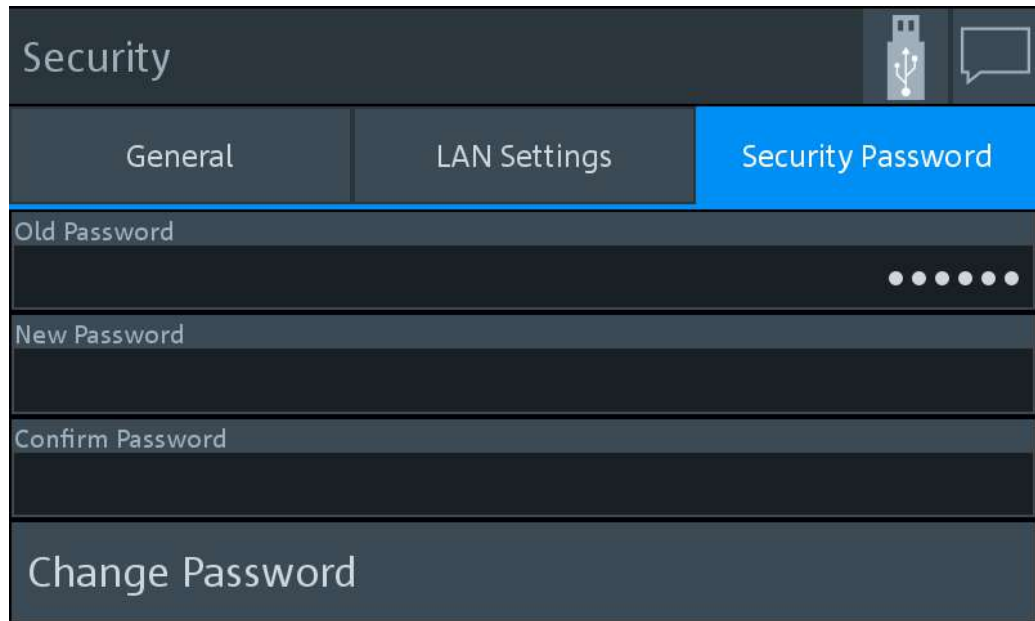
**Old Password ← Security Password tab**

Currently used security password. The preconfigured password is 123456.

Note: We recommend that you change the preconfigured password before connecting the R&S NRT2 to a network.

The security password is required for changing security settings in the "Security" dialog.

New Password ← Security Password tab

New security password.

Confirm Password ← Security Password tab

New security password for confirmation.

Note: The new password is not assigned until you tap "Change Password".

Change Password ← Security Password tab

Sets the new password as security password.

9.2.3 Option Settings

Access: [System] > "Instrument Info" > "Options"

Displays installed options and offers an interface to install new options.

The "Options" dialog contains the following parameters:

HW Options tab	79
Details tab	80

HW Options tab

Displays the installed hardware options.

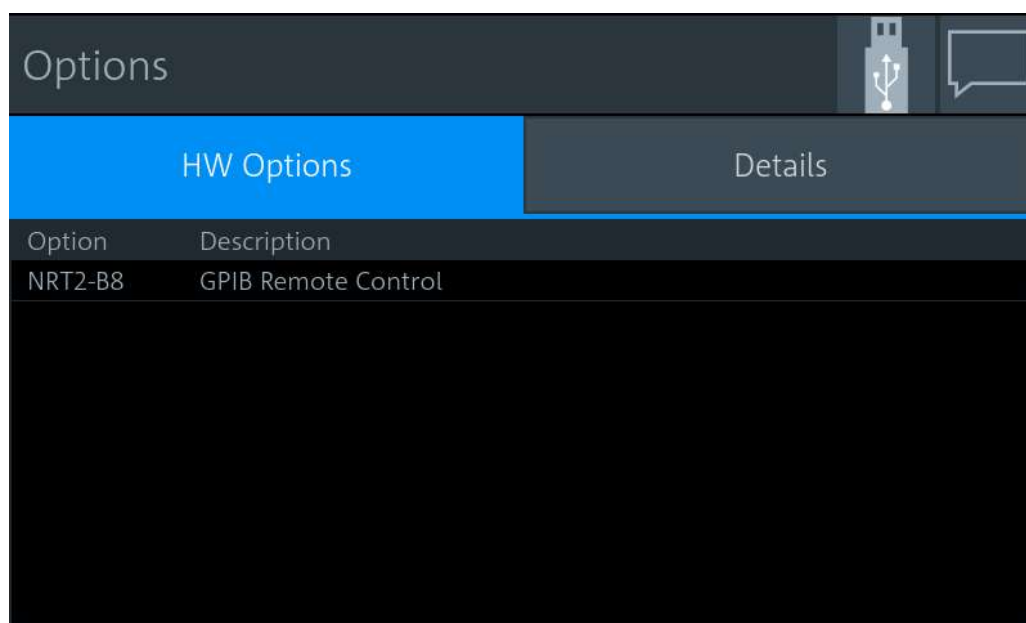

Remote command:

*[OPT?](#) on page 105

Details tab

Displays the installed hardware options.

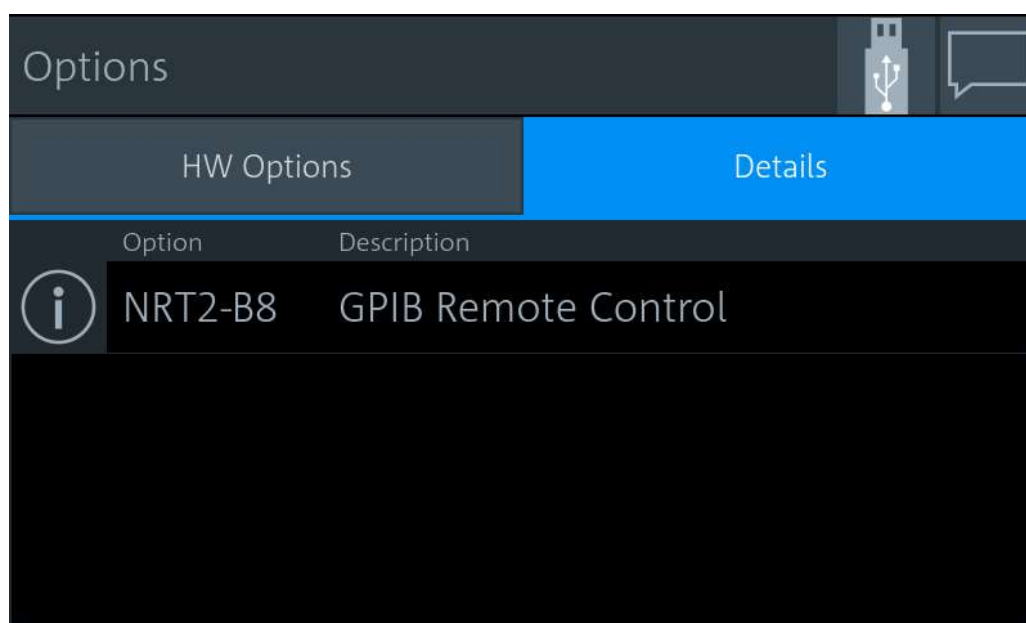

If you want to see more information on a specific option, tap .

Option Detailed Info	
Option	NRT2-B8
Description	GPIB Remote Control
Format ID	0
Stock No	1430.0105K02
Option Index	2008
Option Privilege	Customer Order
Created On	2017-03-30 15:44
License Count	1
Activation Type	Permanent
Valid From	-
Valid To	-
Expiration	-

9.2.4 Open Source Licenses

Access: [System] > "Instrument Info" > "Open Source Licenses"

Displays the license texts of open source software packages used in the R&S NRT2 software. Under "Component", select the open source software package you want to display the license text of.

9.3 Hardware Configuration

Access: [System] > "Hardware Config"

System Overview				
Connections	Instrument Info	Hardware Config	Test	Global Settings
Assembly		Part Number	Serial	Revision
Power Meter NRT2		1430.0509.02	100000	01.00
Mainboard		1424.7405.02	100000	01.00
Display Adapter Board		1424.8224.02	100000	01.00
Keypad Board		1424.8101.02	100000	01.00
NRT Sensor Adapter Board		1430.0850.02	100000	02.00
USB Connector Board		1424.8001.02	100000	01.00
IEC BUS BOARD		1424.8418.02	101320	02.04

Lists the hardware details of the R&S NRT2 assemblies. This tab can be useful for looking up the revision of hardware, for example when troubleshooting.

9.4 Test

Access: [System] > "Test"

System Overview	
Connections	Instrument Info
Hardware Config	Test
Global Settings	
Test Keyboard	Keyboard Test Verdict Passed 2018-06-12 08:55
Test Display	Display Test Verdict Passed 2018-06-12 08:55
Test Touch Panel	Touch Test Verdict Passed 2018-06-12 08:58
Create R&S Support Information	

On this tab, you can test whether the user interfaces are in working order and create information useful for troubleshooting.

For testing a connected power sensor, see "[Sensor Test](#)" on page 72.

Testing the user interfaces

1. Tap the test you want to perform.

A dialog with detailed test instructions is displayed.

2. Read and follow the instructions.
3. Exit the test.

Note: "Exit with PASS" only becomes available when the test is finished successfully.

The results, passed or failed, are displayed for each test.

Remote command:

Creating information for troubleshooting

You can save information for troubleshooting on a memory stick.

1. Connect a memory stick to one of the USB interfaces.
2. Tap "Create R&S Support Information".

The created archive file (*.tar.gz) contains the following information:

- Software errors
- Hardware status
- Current device footprint
- Current device settings

If a memory stick is connected, the archive file is saved there.

Alternatively, you can transfer the information using secure shell (SSH). See ["SSH"](#) on page 78.

9.5 Global Settings

Access: [System] > "Global Settings"

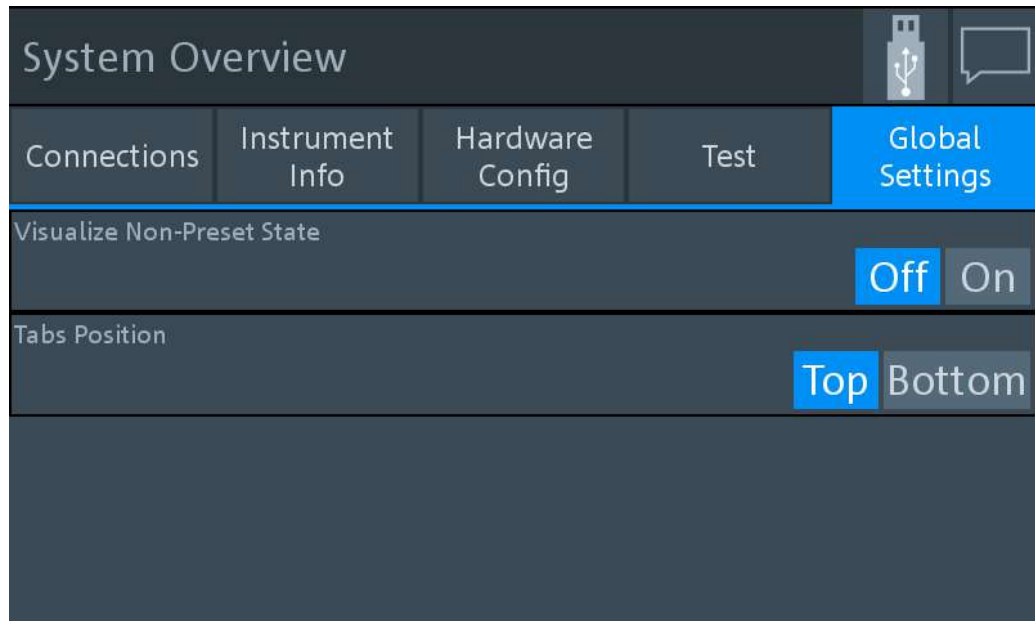

On this tab, you configure the following settings:

Visualize Non-Preset State	84
Tabs Position	84

Visualize Non-Preset State

If enabled, a setting that differs from the preset value is indicated by a pencil symbol.



The control elements in the hierarchies above that are leading to this setting are marked, too. Thus, you can find the setting easily if you want to use a preset value.

Tabs Position

Specifies the position of the tabs in dialogs, top or bottom.

10 Firmware Update

This chapter contains information on installing/updating the firmware on the R&S NRT2.

The latest firmware update files are available on our Internet site at www.rohde-schwarz.com.

NOTICE

Potential damage to the firmware of the device

Disconnecting the power supply while an update is in progress can lead to missing or faulty firmware.

Special care must be taken on not disconnecting the power supply while the update is in progress. Interrupting the power supply during the firmware update will most likely lead to an unusable device which needs to be sent in for maintenance.

10.1 Firmware Update via PC and USB or Ethernet Connection

This chapter contains information on installing/updating the firmware on the R&S NRT2 via PC and USB or Ethernet connection.

Use the Firmware Update program (PureFW) to load new firmware for the R&S NRT2. It is part of the R&S NRP Toolkit.

10.1.1 Hardware and Software Requirements

The system requirements to perform a firmware update via PC are as follows:

- PC with free USB port (alternatively: PC and instrument are connected to an Ethernet network)
- USB cable (USB-A plug to USB-B plug) (alternatively: Ethernet cable)
- Operating system Microsoft Windows 7, Microsoft Windows 8 or Microsoft Windows 10
- **VISA software must be installed on your PC.**
- The R&S NRP Toolkit software must be installed on your PC (includes Firmware Update program).
- A Rohde & Schwarz update file (*.rsu) for the sensor must be available.

10.1.2 Preparing an Update

To prepare an update via USB connection:

1. Make sure a recent VISA software is installed. Firmware update with PureFW can only be performed with the device recognized as a VISA device.
2. Connect the R&S NRT2 to the PC using a USB cable. If the instrument is off, switch it on.
Shortly afterwards, the PC should have identified the new USB hardware in case the instrument is connected via USB.
If no recent VISA software is installed, Windows will try in vain to find a USB driver for the instrument. If this happens, the instrument is highlighted by a yellow exclamation mark in the Windows device manager.
⇒ Abort the installation process and install a recent VISA software.

To prepare an update via network connection:

1. Make sure a recent VISA software is installed. Firmware update with PureFW can only be performed with the device recognized as a VISA device.
2. Connect the R&S NRT2 to the network. If the instrument is off, switch it on.
To check that the instrument is assigned an IP address, press the hardkey [System] on the front of the R&S NRT2, choose the "Connections" tab, and check the IPv4 status under "Network":

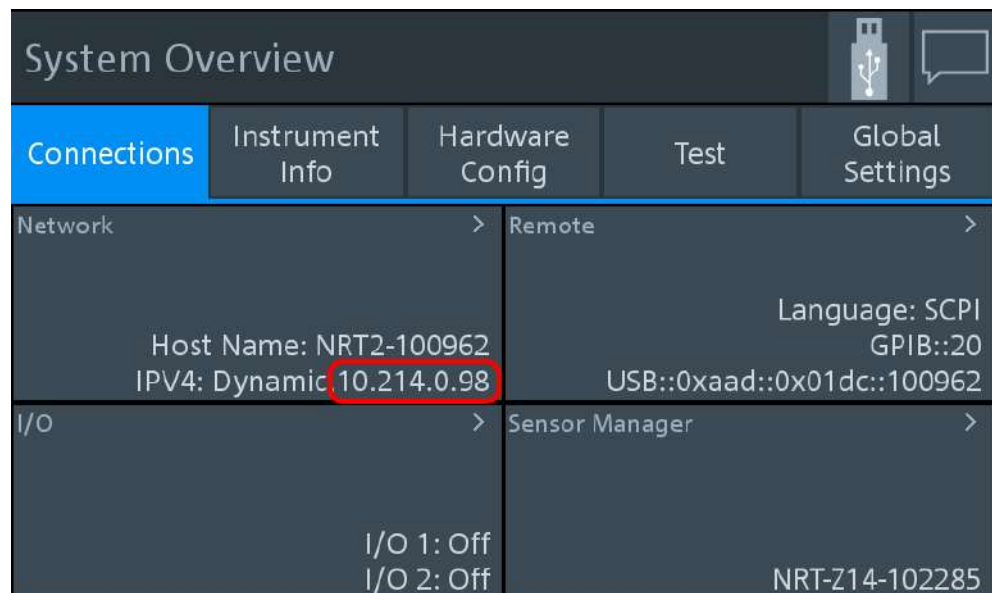

If the instrument is not assigned an IP address, perform the following:

- a) Open the dialog "Network" and check whether the network settings are correct.
- b) Check the cable used to connect the instrument to the network.

3. Register the instrument as a VISA device. Refer to documentation of your VISA software for details.

10.1.3 Updating the Application Firmware

To perform a firmware update:

1. Start the Firmware Update program (PureFW) via "Start menu > NRP-Toolkit > Firmware Update". The following window should appear:



The program automatically starts scanning for R&S power sensors and meters attached via USB. When the scan is completed, all recognized power sensors and meters are listed in the "Device" dropdown control.

2. If the instrument you want to update is not listed in the "Device" dropdown control, perform one of the following:
 - a) If the instrument is connected to the PC via USB, press "Rescan" to search for R&S power sensors and meters attached via USB.

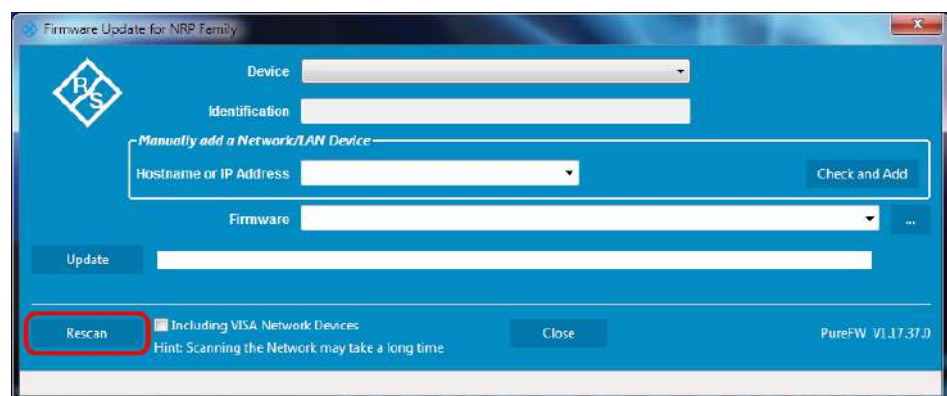

Firmware Update via PC and USB or Ethernet Connection

- b) If the instrument is connected to the network, enter the hostname or the IP address of the instrument in the field "Manually add a Raw SCPI Device" and then press "Check and Add" or Enter.

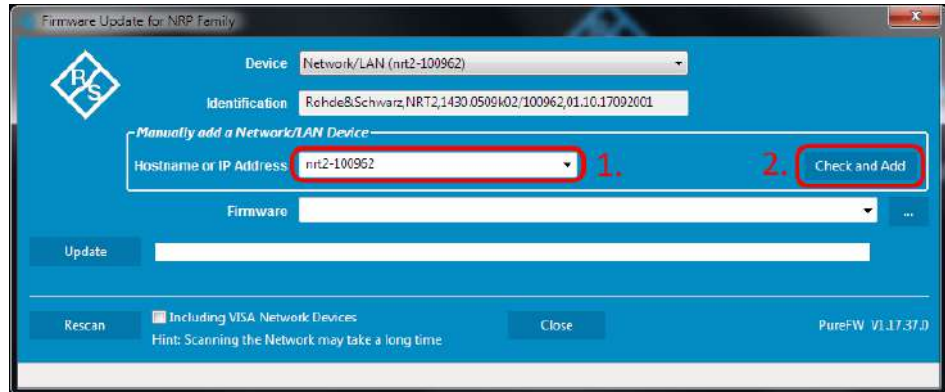

The program searches for the specified instrument on the network and adds it to the "Device" list.

- c) It is also possible to scan the local network for VISA network devices automatically. This can be more time-consuming than adding the device manually as described above. To do this, check the setting "Including VISA Network Devices" before you press "Rescan".

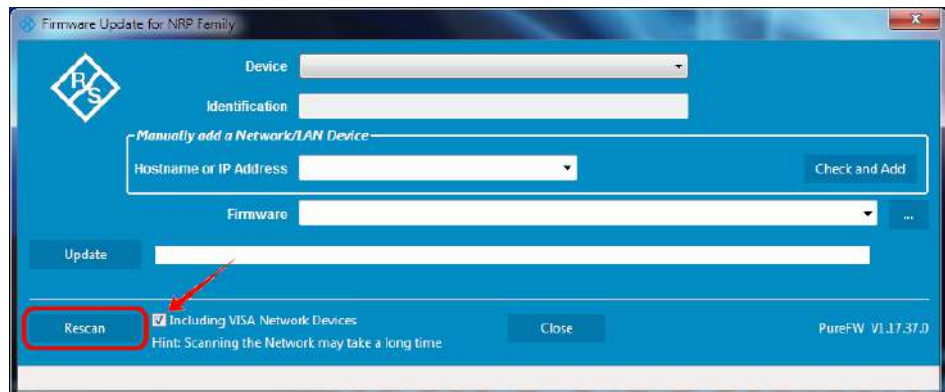

- d) Check whether a VISA library is installed on the computer.
 If no VISA library is installed on the computer, no VISA instrument will be accessible.
 If a network connection is used: Check whether the instrument is registered as a VISA device.
3. In the "Device" line select the instrument you want to update.

Firmware Update via PC and USB or Ethernet Connection



The "Hostname or IP Address" field is not used during this procedure and should therefore be left empty.

- In the "Firmware" field enter the full path and file name of the update file or press the ellipsis button to browse the file system for it. New firmware for the R&S NRT2 generally has an *.rsu (Rohde & Schwarz Update) extension.

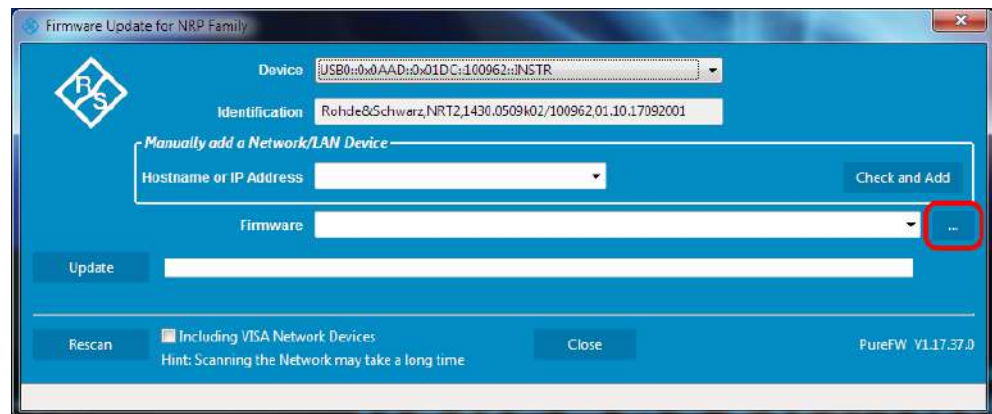

- Select "Update" to download the new firmware and program it into the flash memory of the instrument.

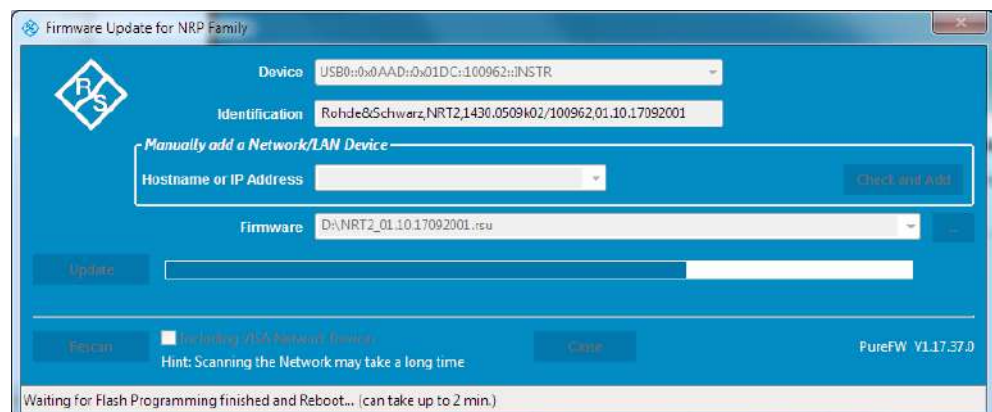

During the update process the progress is shown through a progress bar. The update sequence may take a couple of minutes.

6. Check if the update was successful. This is the case if the firmware version in the "Identification" field is the same as the one you loaded in the "Firmware" field.

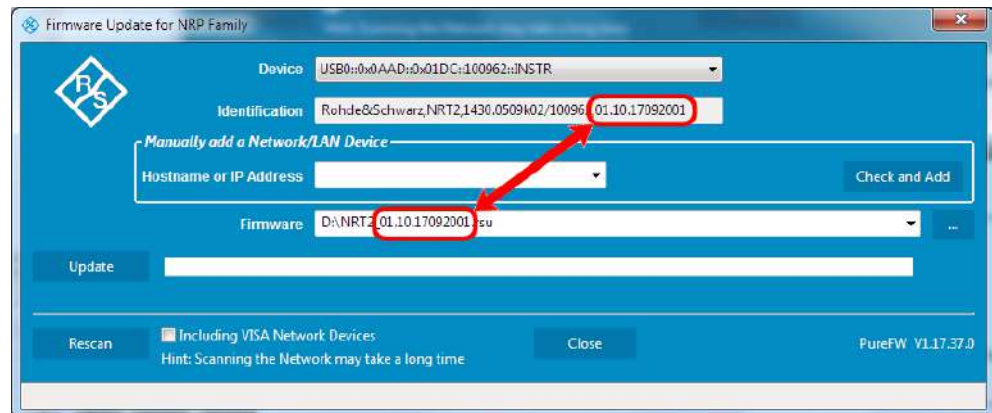

10.2 Firmware Update via a USB Flash Memory Stick

This chapter contains information on installing/updating the firmware on the R&S NRT2 via a USB flash memory stick.



The R&S NRT2 supports this update method from version 02.xx of the installed firmware. With version 01.xx installed, perform an update to version 02.xx or later with the method described in section [Chapter 10.1, "Firmware Update via PC and USB or Ethernet Connection"](#), on page 85 first.

10.2.1 Hardware and Software Requirements

The system requirements to perform a firmware update via a USB flash memory stick are as follows:

- PC or mobile device with free USB port running any operating system and software that supports copying files to the USB flash memory stick
- USB flash memory stick (USB 2.0 or 3.0, with USB-A plug, FAT32 file system, and sufficient space for the firmware file)
- A Rohde & Schwarz update file (*.rsu) for the sensor must be available.

10.2.2 Preparing an Update

To prepare an update via USB flash memory stick:

1. Copy the Rohde & Schwarz update file to the root directory of the USB flash memory stick.

2. Disconnect the USB flash memory stick from the PC or mobile device. If the instrument is off, switch it on.

10.2.3 Updating the Application Firmware

To perform a firmware update:

1. Connect the USB flash memory stick to the front or rear USB host port of the R&S NRT2.
Shortly afterwards, the instrument should have identified the USB flash memory stick. A dialog will appear that allows selection of the Rohde & Schwarz update file (if there is more than one that matches the instrument) and asks for confirmation to start the update.
2. If there are more than one matching Rohde & Schwarz update files, select the file you want to use for the update. The latest version is on top. Then, press "Update" to start the update process.
3. After copying the Rohde & Schwarz update file to internal memory, a dialog will appear that asks you to remove the installation medium (USB flash memory stick) and press "OK" to reboot the instrument. Remove the stick and confirm with "OK". (If the stick is not removed at this point of the update process, the firmware update process will start another time after the reboot. In this case, interrupt it by pressing "Cancel" when the selection dialog appears.)

11 Remote Control

For information on remote basics, see the Rohde & Schwarz website at www.rohde-schwarz.com/rc-via-scp

11.1 Notation for SCPI Commands

In the following sections, all commands implemented in the device are listed according to the command system and then described in detail. For the most part, the notation used complies with SCPI specifications. The commands are separated in high-level and low-level commands, where the high-level commands combine several low-level commands in one command.

Numeric suffixes <n>

If a command can be applied to multiple instances of an object, e.g. specific sensors, the required instances can be specified by a suffix added to the command. Numeric suffixes are indicated by angular brackets (<1...4>, <n>, <i>) and are replaced by a single value in the command. Entries without a suffix are interpreted as having the suffix 1.

Optional keywords []

Some command systems permit certain keywords to be inserted into the header or omitted. These keywords are marked by square brackets in the description. The instrument must recognize the long command to comply with the SCPI standard. Some commands are considerably shortened by these optional mnemonics.

Therefore, not only is there a short and a long form for the commands (distinguished here by lowercase and uppercase letters) but also a short form which is created by omitting optional keywords.

Example:

Command [SENSe<[1]..4>]:CORRection:GAIN2[:INPut][:MAGNitude] 1
can be written as:

```
SENSe1:CORRection:GAIN2:INPut:MAGNitude 1
SENSe1:CORRection:GAIN2:INPut 1
SENSe1:CORRection:GAIN2 1
SENSe:CORRection:GAIN2 1
CORRection:GAIN2 1
```

Parameters

Parameters must be separated from the header by a "white space". If several parameters are specified in a command, they are separated by a comma (,).

Example:

Definition: `OUTPut:AUDiobits <audiobits>`

Command: `OUTP:AUD 24`

Special characters | and { }

	<p>A vertical bar in parameter definitions indicates alternative possibilities in the sense of "or". The effect of the command differs, depending on which parameter is used.</p> <p>Example:</p> <p>Definition: <code>INITiate:CONTInuous ON OFF</code></p> <p>Command <code>INITiate:CONTInuous ON</code> starts the measurements</p> <p>Command <code>INITiate:CONTInuous OFF</code> stops the measurements</p>
{ }	Parameters in braces may be included in the command once, several times or not at all.

11.2 Status Reporting System

The status reporting system stores all information on the current operating state of the instrument, and on errors which have occurred. This information is stored in the status registers and in the error queue. You can query both with the commands of the `STATus` subsystem.

11.2.1 Hierarchy of the Status Registers

[Figure 11-1](#) shows the hierarchical structure of information in the status registers.

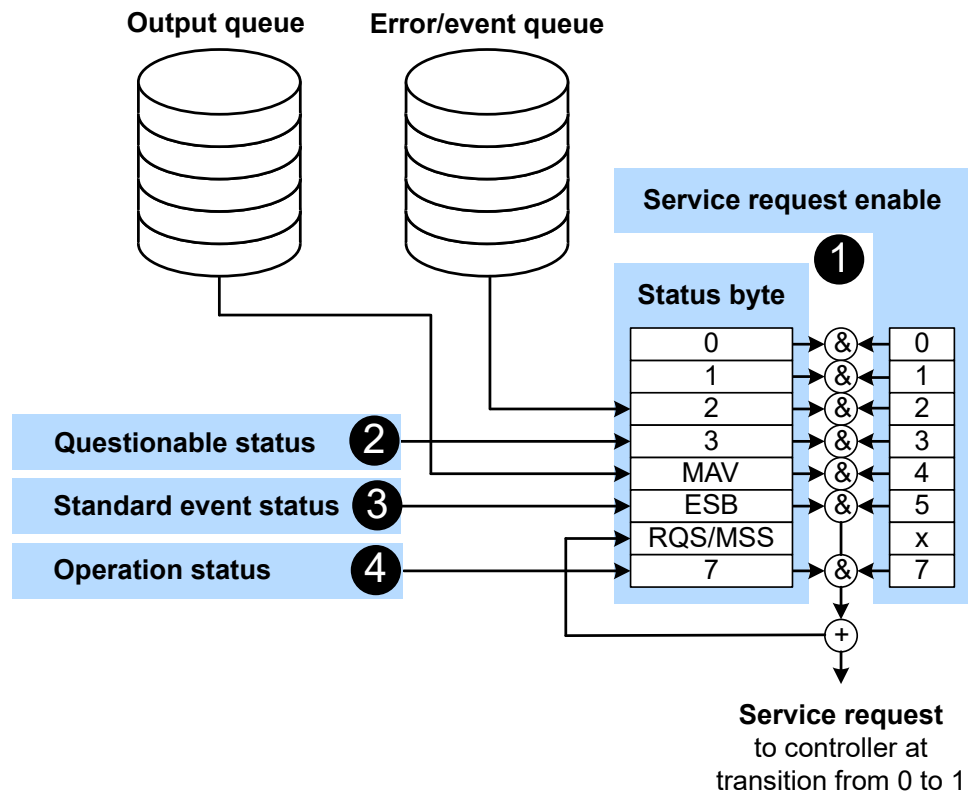

Figure 11-1: Status registers overview

1 = Chapter 11.2.3, "Status Byte (STB) and Service Request Enable Register (SRE)", on page 96

2 = Chapter 11.2.5, "Questionable Status Register", on page 97

3 = Chapter 11.2.6, "Standard Event Status and Enable Register (ESR, ESE)", on page 98

4 = Chapter 11.2.7, "Operation Status Register", on page 99

The highest level is formed by the status byte register (STB) and the associated service request enable (SRE) register.

The status byte register (STB) receives its information from:

- Standard event status register (ESR)
- Associated standard event status enable register (ESE)
- SCPI-defined operation status register
- Questionable status register, which contains detailed information on the device.
- Device status register

11.2.2 Structure of a SCPI Status Register

Each SCPI register consists of five 16-bit registers that have different functions, see [Figure 11-2](#). The individual bits are independent of each other, i.e. each hardware status is assigned a bit number which is the same for all five registers. Bit 15, the most-

significant bit, is set to 0 in all registers, thus preventing problems some controllers have with the processing of unsigned integers.

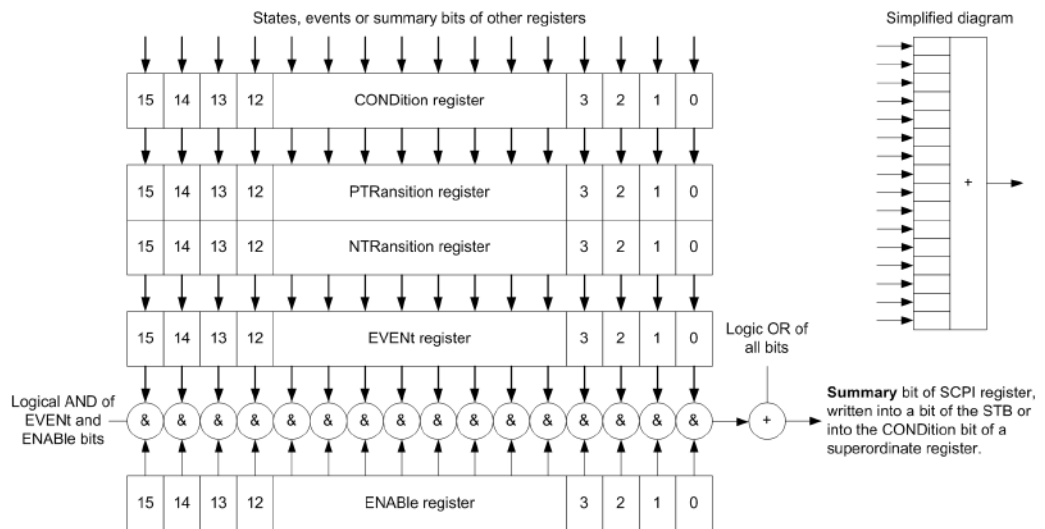

Figure 11-2: Standard SCPI status register

CONDition status register part

The five parts of a SCPI register have different properties and functions:

The **CONDition** part is written into directly by the hardware or the sum bit of the next lower register. Its contents reflect the current instrument status. This register part can only be read, but not written into or cleared. Its contents are not affected by reading.

PTRansition / NTRansition status register part

The two transition register parts define which state transition of the **CONDition** part (none, 0 to 1, 1 to 0 or both) is stored in the **EVENT** part.

The *Positive TRansition* part acts as a transition filter. When a bit of the **CONDition** part is changed from 0 to 1, the associated **PTR** bit decides whether the **EVENT** bit is set to 1.

- **PTR** bit = 1: The **EVENT** bit is set.
- **PTR** bit = 0: The **EVENT** bit is not set.

This part can be written into and read as required. Its contents are not affected by reading.

The *Negative TRansition* part also acts as a transition filter. When a bit of the **CONDition** part is changed from 1 to 0, the associated **NTR** bit decides whether the **EVENT** bit is set to 1.

- **NTR** bit = 1: The **EVENT** bit is set.
- **NTR** bit = 0: The **EVENT** bit is not set.

This part can be written into and read as required. Its contents are not affected by reading.

EVENT status register part

The `EVENT` part indicates whether an event has occurred since the last reading, it is the "memory" of the condition part. It only indicates events passed on by the transition filters. It is permanently updated by the instrument.

You can only read this part. Reading the register clears it. This part is often equated with the entire register.

ENABLE status register part

The `ENABLE` part determines whether the associated `EVENT` bit contributes to the sum bit (see below). Each bit of the `EVENT` part is "ANDed" with the associated `ENABLE` bit (symbol '&'). The results of all logical operations of this part are passed on to the sum bit via an "OR" function (symbol '+').

`ENABLE` bit = 0: The associated `EVENT` bit does not contribute to the sum bit.

`ENABLE` bit = 1: If the associated `EVENT` bit is 1, the sum bit is set to 1 as well.

You can read and write as required. Its contents are not affected by reading.

Sum bit

The sum bit is obtained from the `EVENT` and `ENABLE` part for each register. The result is then entered into a bit of the `CONDition` part of the higher-order register.

The instrument automatically generates the sum bit for each register. Thus an event can lead to a service request throughout all levels of the hierarchy.

11.2.3 Status Byte (STB) and Service Request Enable Register (SRE)

The status byte register is already defined in IEEE 488.2. It gives a rough overview of the instrument status, collecting information from the lower-level registers. It is comparable with the `CONDition` register of a SCPI defined register and is at the highest level of the SCPI hierarchy. Its special feature is that bit 6 acts as the summary bit of all other bits of the status byte register.

The status byte register is read by `*STB?` or a serial poll. The service request enable register is associated with the status byte register. The function of the service request enable register corresponds to that of the `ENABLE` register of the SCPI registers. Each bit of the status byte register is assigned a bit in the service request enable register. Bit 6 of the service request enable register is ignored. If a bit is set in the service request enable register and the associated bit in the status byte register changes from 0 to 1, a service request (SRQ) is generated on the IEC/IEEE bus. This service request triggers an interrupt in the controller configured for this purpose, and can be further processed by the controller.

Set and read the service request enable register using `*SRE`.

See [Figure 11-1](#).

Table 11-1: Used status byte bits and their meaning

Bit no.	Short description	Bit is set if
2	Error queue not empty	The error queue has an entry. If this bit is enabled by the service request enable register, each entry of the error queue generates a service request. An error can thus be recognized and specified in detail by querying the error queue. The query yields a conclusive error message. This procedure is recommended since it considerably reduces the problems of IEC/IEEE-bus control.
3	Questionable status register summary	An <code>EVENT</code> bit is set in the <code>QUESTIONABLE</code> status register and the associated <code>ENABLE</code> bit is set to 1. A set bit denotes a questionable device status which can be specified in greater detail by querying the questionable status register. Chapter 11.2.5, "Questionable Status Register" , on page 97
4	MAV Message available	A readable message is in the output queue. This bit can be used to automate reading of data from the instrument into the controller.
5	ESB Standard event status register summary	One of the bits in the standard event status register is set and enabled in the event status enable register. Setting this bit denotes a serious error which can be specified in greater detail by querying the standard event status register. Chapter 11.2.6, "Standard Event Status and Enable Register (ESR, ESE)" , on page 98.
6	MSS Master status summary	The instrument triggers a service request, which happens if one of the other bits of this register is set together with its enable bit in the service request enable register (SRE).
7	Operation status register summary	An <code>EVENT</code> bit is set in the operation status register and the associated <code>ENABLE</code> bit is set to 1. A set bit denotes that an action is being performed by the instrument. Information on the type of action can be obtained by querying the operation status register. Chapter 11.2.7, "Operation Status Register" , on page 99

11.2.4 IST Flag and Parallel Poll Enable Register (PPE)

Similar to the service request (SRQ), the IST flag combines the complete status information in a single bit. It can be queried by a parallel poll or by `*IST?`.

The parallel poll enable register (PPE) determines which bits of the STB affect the IST flag. The bits of the STB are ANDed with the corresponding bits of the PPE; bit 6 is also used, in contrast to the service request enable register. The IST flag is obtained by ORing all results together.

Set and read the parallel poll enable register using `*PRE`.

11.2.5 Questionable Status Register

Contains information on questionable instrument states that occur if the instrument is not operated in compliance with its specifications.

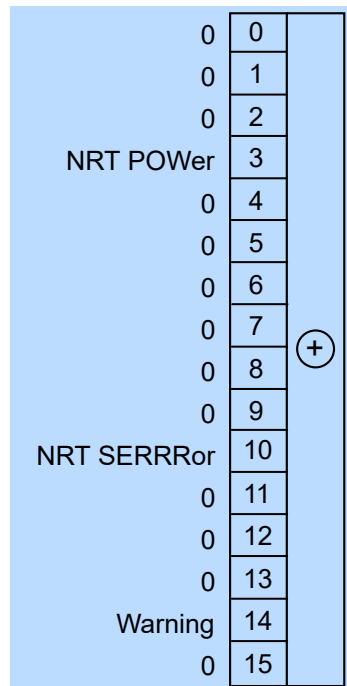

Figure 11-3: Questionable status register

Querying the register:

- `STATUS:QUESTIONABLE:CONDITION?`
- `STATUS:QUESTIONABLE[:EVENT]?`

Table 11-2: Used questionable status bits and their meaning

Bit no.	Short description	Bit is set if
3	NRT POWer	<ul style="list-style-type: none"> • Sensor is overloaded; the forward or reverse power exceeds the maximum values specified for the sensor. • The measured values for power or matching exceed the limit values. • The central supply voltage for power sensor and R&S NRT2 exceeds or falls below the allowed limits.
10	NRT SERRRor	Static error of the R&S NRT-Zxx power sensor occurred.
14	Warning	

11.2.6 Standard Event Status and Enable Register (ESR, ESE)

The `ESR` is already defined in the IEEE 488.2 standard. It is comparable to the `EVENT` register of a SCPI register. The standard event status register can be read out by `*ESR?`.

The `ESE` forms the associated `ENABLE` register. It can be set and read by `*ESE`.

Operation Complete	0	+
0	1	
Query Error	2	
Device-Dependent Error	3	
Execution Error	4	
Command Error	5	
User Request	6	
Power On	7	

Figure 11-4: Standard event status register (ESR)

Table 11-3: Used standard event status bits and their meaning

Bit no.	Short description	Bit is set if
0	Operation complete	All previous commands have been executed and *OPC is received.
2	Query error	The controller wants to read data from the instrument but has not sent a query, or it sends new commands to the instrument before it retrieves existing requested data. A frequent cause is a faulty query which cannot be executed.
3	Device-dependent error	A instrument-dependent error occurs. An error message with a number between -300 and -399 or a positive error number denoting the error in greater detail is entered in the error queue.
4	Execution error	The syntax of a received command is correct but the command cannot be executed due to various marginal conditions. An error message with a number between -200 and -300 denoting the error in greater detail is entered in the error queue.
5	Command error	An undefined command or a command with incorrect syntax is received. An error message with a number between -100 and -200 denoting the error in greater detail is entered in the error queue.
6	User request	The instrument is switched over to manual control.
7	Power on	The instrument is switched on.

11.2.7 Operation Status Register

Contains information on current operations, CONDition register, or operations performed since the last query, EVENT register.

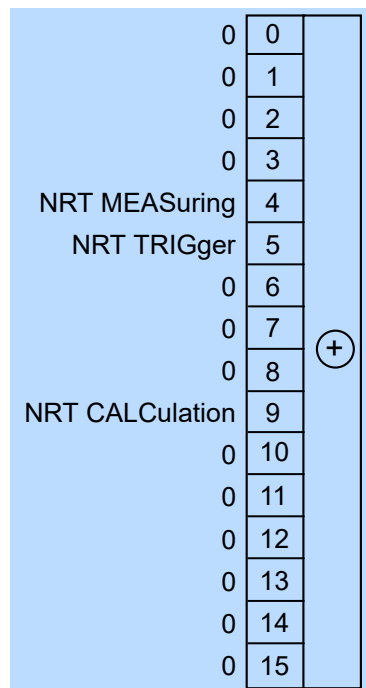

Figure 11-5: Operation status register

Querying the register:

- `STATus:OPERation:CONDition?`
- `STATus:OPERation[:EVENT]?`

Table 11-4: Used operation status bits and their meaning

Bit no.	Short description	Bit is set if
4	NRT MEASuring	R&S NRT2 is measuring.
5	NRT TRIGger	R&S NRT2 is waiting for trigger event.
9	NRT CALCulation	R&S NRT2 performs a limit check.

11.3 Common Commands

<code>&ABO</code>	101
<code>&DFC</code>	101
<code>&GET</code>	101
<code>&GTL</code>	102
<code>&GTM</code>	102
<code>&GTR</code>	102
<code>&HFC</code>	102
<code>&LLO</code>	102
<code>&NREN</code>	102
<code>*CLS</code>	102
<code>*DEV</code>	103

*DMC.....	103
*EMC.....	103
*ESE.....	103
*ESR?.....	103
*GCLS.....	103
*GMC?.....	104
*GOPC?.....	104
*GWAI.....	104
*IDN?.....	104
*IST?.....	104
*LMC?.....	104
*OPC.....	105
*OPT?.....	105
*PMC.....	105
*PRE.....	105
*PSC.....	106
*RCL.....	106
*RMC.....	106
*RST.....	106
*SAV.....	106
*SRE.....	107
*SRQ?.....	107
*STB?.....	107
*TRG.....	107
*TST?.....	107
*WAI.....	108
*XESE.....	108
*XESR?.....	108
*XPRES.....	108
*XSRE.....	109
*XSTB?.....	109

&ABO

Device clear

Usage: Event

&DFC

Disable flow control

Usage: Event

&GET

Group execute trigger

Usage: Event

>L

Goto local

Usage: Event

>M

Goto local with remote state.

Usage: Event

>R

Goto remote

Usage: Event

&HFC

Hardware flow control

Usage: Event

&LLO

Local lockout

Usage: Event

&NREN

Not remote enabled (goto local)

Usage: Event

***CLS**

Clear Status

Resets the:

- Status byte (STB)
- Standard event register (ESR)
- EVENT part of the QUESTIONABLE and the OPERATION register
- Error/event queue

The command does not alter the ENABLE and TRANSITION parts of the registers.

Usage: Event

***DEV** [<instrument_no>]

This command returns the selected "instrument" of the device. The command can be used to select between different "instruments" in a multichannel device.

Parameters:

<instrument_no> The assigned instrument.

DMC** <Label>, <Macro>DMC?** <Label>

Defines a macro command.

Parameters:

<Macro>

Parameters for setting and query:

<Label>

***EMC** <Enable>

Enables macro command.

Parameters:

<Enable>

***ESE** <register>

Event Status Enable

Sets the event status enable register to the specified value. The query returns the contents of the event status enable register in decimal form.

Parameters:

<register>	Range:	0 to 255
	*RST:	0

***ESR?**

Event Status Read query

Returns the contents of the event status register in decimal form (0 to 255) and subsequently sets the register to zero.

Usage: Query only

***GCLS**

Clears all status information in all internal "instruments".

Usage: Event

***GMC? <Label>**

Get macro content.

Query parameters:

<Label>

Return values:

<Macro> <dblock>

Usage: Query only

***GOPC?**

Analogue of *OPC? for all instruments in multichannel device.

Return values:

<gopc> "1" is return if all pending operations in all internal "instruments" are finished.

Usage: Query only

***GWA**

Waits for all pending operations in all internal "instruments".

Usage: Event

***IDN?**

IDeNtification query

Returns a string with information on the sensor's identity (device identification code). In addition, the version number of the installed firmware is indicated.

Usage: Query only

***IST?**

Individual SStatus query

Returns the current value of the IST flag in decimal form. The IST flag is the status bit which is sent during a parallel poll.

Usage: Query only

***LMC?**

List macro commands.

Return values:

<Label>

Usage: Query only

*OPC

OPeration Complete

Sets bit 0 in the event status register when all preceding commands have been executed. This bit can be used to initiate a service request. *OPC must be sent at the end of a program message.

The query form returns a "1" when all previous commands have been processed. It is important that the read timeout is set sufficiently long.

Since *OPC? waits until all previous commands are executed, "1" is returned in all cases.

*OPC? basically functions like the *WAI command, but *WAI does not return a response.

*OPC? is preferred to *WAI because with *OPC?, the execution of commands can be queried from a controller program before new commands are sent. This prevents overflow of the input queue when too many commands are sent that cannot be executed.

Unlike *WAI, *OPC? must be sent at the end of a program message.

*OPT?

OPTion identification query

Returns a comma-separated list of installed options.

Usage: Query only

Manual operation: See "[HW Options tab](#)" on page 79

*PMC

Purge macro command.

Usage: Event

*PRE <register>

Parallel poll Register Enable

Sets the parallel poll enable register to the specified value or queries the current value.

Parameters:

<register>	Range:	0 to 255
	*RST:	0

***PSC** <psc>

Writes/reads the power on status clear flag (PSC).

Parameters:

<psc> Power on status clear flag.

***RCL** <number>

ReCaLI

Calls the device state which has been stored with the ***SAV** command under the specified number.

Setting parameters:

<number> Range: 0 to 9
 *RST: 0

Usage: Setting only

Manual operation: See "[Recall](#)" on page 58

***RMC** <Label>

Remove macro content.

Setting parameters:

<Label>

Usage: Setting only

***RST**

ReSeT

Sets the sensor to the default state, i.e. the default settings for all parameters are loaded. The command corresponds to the command [SYSTem:PRESet](#).

Usage: Event

Manual operation: See "[Preset](#)" on page 58

***SAV** <number>

SAVe

Stores the current device state under the specified number. The storage numbers 0 to 9 are available.

Setting parameters:

<number> Range: 0 to 9
 *RST: 0

Usage: Setting only

Manual operation: See "Save" on page 58

***SRE** <register>

Service Request Enable

Sets the service request enable register to the specified value. This command determines under which conditions a service request is triggered.

Parameters:

<register> Range: 0 to 255
 *RST: 0

***SRQ?** [<timeout>]

A generic `srq wait` command to be used without `srq event transport`. It is simply read from the interface.

Query parameters:

<timeout>

Return values:

<srq>

Usage: Query only

***STB?**

Status Byte query

Returns the contents of the status byte in decimal form.

Usage: Query only

***TRG**

TRiGger

Triggers a measurement. This command is only valid if the power sensor is in the `WAIT_FOR_TRIGGER` state and the trigger source is set to `BUS`

Usage: Event

***TST?**

Selftest query

Triggers a self test of the instrument and outputs an error code in decimal form. 0 indicates that no errors have occurred.

Example: *TST?
 Query
 0
 Response: Passed

Example: *TST?
 Query
 1
 Response: Failed

Usage: Query only

*WAI

WAI to continue

Prevents the execution of the subsequent commands until all preceding commands have been executed and all signals have settled.

Usage: Event

*XESE <xese>

This command specifies the standard event status enable register (ESE). This register determines which events from the standard event status register (ESR) are summarized in bit 5 (the event summary bit ESB) of the status byte.

Parameters:

<xese> <expr>

*XESR?

This command reads the standard event status register (ESR). This command causes the register to be cleared.

Return values:

<xesr> <expr>

Usage: Query only

*XPRES <xpre>

This command reads/writes the parallel pll enable register (PRE).

Parameters:

<xpre> <expr>
 Parallel poll enable register.

CALCulate<Measurement>:METer<DirectionalChannel>:UPPer[:DATA]:RATio:RFRatio.....	119
CALCulate<Measurement>:METer<DirectionalChannel>:UPPer[:DATA]:RATio:RLOSs.....	119
CALCulate<Measurement>:METer<DirectionalChannel>:UPPer[:DATA]:RATio:SWR.....	120
CALCulate<Measurement>:METer<DirectionalChannel>:UPPer[:DATA]:RATio[:VALue].....	120
CALCulate<Measurement>:METer<DirectionalChannel>:UPPer[:DATA][:POWER].....	120
CALCulate<Measurement>:RELative<DirectionalChannel>:CCDF.....	121
CALCulate<Measurement>:RELative<DirectionalChannel>:POWER.....	121
CALCulate<Measurement>:RELative<DirectionalChannel>:RATio:RCOefficient.....	121
CALCulate<Measurement>:RELative<DirectionalChannel>:RATio:RFRatio.....	122
CALCulate<Measurement>:RELative<DirectionalChannel>:RATio:RLOSs.....	122
CALCulate<Measurement>:RELative<DirectionalChannel>:RATio:SWR.....	122
CALCulate<Measurement>:RELative<DirectionalChannel>:RATio[:VALue].....	123
CALCulate<Measurement>:RELative<DirectionalChannel>[:STATe].....	123
CALCulate<Measurement>:RESolution.....	123
CALCulate<Measurement>[:CHANnel<Channel>]:AVERage:COUNT:AUTO[:STATe].....	124
CALCulate<Measurement>[:CHANnel<Channel>]:AVERage:COUNT[:VALue].....	124
CALCulate<Measurement>[:CHANnel<Channel>]:CORRection:OFFSet:RPLane.....	124
CALCulate<Measurement>[:CHANnel<Channel>]:CORRection:OFFSet:STATe.....	125
CALCulate<Measurement>[:CHANnel<Channel>]:CORRection:OFFSet[:MAGNitude].....	125
CALCulate<Measurement>[:CHANnel<Channel>]:FEED.....	125
CALCulate<Measurement>[:CHANnel<Channel>]:NRT:APERture:MODE.....	126
CALCulate<Measurement>[:CHANnel<Channel>]:NRT:APERture[:VALue].....	126
CALCulate<Measurement>[:CHANnel<Channel>]:NRT:BURSt:MODE.....	126
CALCulate<Measurement>[:CHANnel<Channel>]:NRT:BURSt:PERiod.....	127
CALCulate<Measurement>[:CHANnel<Channel>]:NRT:BURSt:WIDTh.....	127
CALCulate<Measurement>[:CHANnel<Channel>]:NRT:CCDF:THReshold.....	127
CALCulate<Measurement>[:CHANnel<Channel>]:NRT:DIRRection.....	128
CALCulate<Measurement>[:CHANnel<Channel>]:NRT:DMODulation:WCDMa:CRATe.....	128
CALCulate<Measurement>[:CHANnel<Channel>]:NRT:DMODulation[:VALue].....	128
CALCulate<Measurement>[:CHANnel<Channel>]:NRT:PEP:HOLD:TIME.....	129
CALCulate<Measurement>[:CHANnel<Channel>]:NRT:VBWidTh[:VALue].....	129
CALCulate<Measurement>:LIMit[:STATe].....	129
CALCulate<Measurement>:LIMit:TYPE.....	130

CALCulate<Measurement>:DMODE <mode>

Selects the display mode. Digital only (SDIG) or digital and analog (SAN).

Suffix:

<Measurement> 1...100

Parameters:

<mode> *RST: SANalog

Manual operation: See "[Display Format](#)" on page 47

CALCulate<Measurement>:HOLD:FUNCTION <function>

Configures the MaxHold function, holding the maximum (MAX), minimum (MIN) or difference of max - min (DIFF).

Suffix:

<Measurement> 1...100

Parameters:

<function> MAX | MIN | DIFFerence

*RST: MAX

Manual operation: See ["Max Hold Function"](#) on page 48**CALCulate<Measurement>:HOLD[:STATe] <state>**

Enables or disables the MaxHold function or reset the currently hold values.

Suffix:

<Measurement> 1...100

Parameters:

<state> OFF | ON | RESet

*RST: OFF

Manual operation: See ["Max Hold"](#) on page 48**CALCulate<Measurement>:LIMit<DirectionalChannel>:LOWer:STATe <state>**

Enables or disables the checking of the lower limit.

Suffix:

<Measurement> 1...100

<DirectionalChannel> 1..2

Parameters:

<state> *RST: OFF

Manual operation: See ["Forward Lower Limit State, Reflection Lower Limit State"](#) on page 48**CALCulate<Measurement>:LIMit<DirectionalChannel>:LOWer[:DATA]:CCDF
<value>**

Lower limit value for CCDF.

Suffix:

<Measurement> 1...100

<DirectionalChannel> 1..2

Parameters:

<value> Range: 0.0 to 100.0

*RST: 0.0

Default unit: pct

Manual operation: See ["Forward Lower Limit, Reflection Lower Limit"](#) on page 48

**CALCulate<Measurement>:LIMit<DirectionalChannel>:LOWer[:DATA]:RATio:
RCoefficient <value>**

Lower limit value for reflection coefficient.

Suffix:

<Measurement> 1...100

<DirectionalChannel> 1..2

Parameters:

<value> Range: -1e18 to 1e18
*RST: 1.0
Default unit: -

Manual operation: See "[Forward Lower Limit, Reflection Lower Limit](#)" on page 48

**CALCulate<Measurement>:LIMit<DirectionalChannel>:LOWer[:DATA]:RATio:
RFRatio <value>**

Lower limit value for ratio of forward/reverse power.

Suffix:

<Measurement> 1...100

<DirectionalChannel> 1..2

Parameters:

<value> Range: 0.0 to 100.0
*RST: 0.0
Default unit: pct

Manual operation: See "[Forward Lower Limit, Reflection Lower Limit](#)" on page 48

**CALCulate<Measurement>:LIMit<DirectionalChannel>:LOWer[:DATA]:RATio:
RLOSS <value>**

Lower limit value for return loss.

Suffix:

<Measurement> 1...100

<DirectionalChannel> 1..2

Parameters:

<value> Range: -200.0 to 200.0
*RST: -200.0
Default unit: dB

Manual operation: See "[Forward Lower Limit, Reflection Lower Limit](#)" on page 48

**CALCulate<Measurement>:LIMit<DirectionalChannel>:LOWer[:DATA]:RATio:
SWR <value>**

Lower limit value for SWR.

Suffix:

<Measurement> 1...100

<DirectionalChannel> 1..2

Parameters:

<value> Range: 0.0 to 1e18
*RST: 1.0
Default unit: -

Manual operation: See "[Forward Lower Limit, Reflection Lower Limit](#)" on page 48

**CALCulate<Measurement>:LIMit<DirectionalChannel>:LOWer[:DATA]:RATio[:
VALue] <value>**

Lower limit value for power ratio.

Suffix:

<Measurement> 1...100

<DirectionalChannel> 1..2

Parameters:

<value> Range: 1e-18 to 1e18
*RST: 1e-2
Default unit: -

Manual operation: See "[Forward Lower Limit, Reflection Lower Limit](#)" on page 48

**CALCulate<Measurement>:LIMit<DirectionalChannel>:LOWer[:DATA][:POWER]
<value>**

Lower limit value for power value.

Suffix:

<Measurement> 1...100

<DirectionalChannel> 1..2

Parameters:

<value> Range: 1e-15 to 1e12
*RST: 1e-9
Default unit: W

Manual operation: See "[Forward Lower Limit, Reflection Lower Limit](#)" on page 48

CALCulate<Measurement>:LIMit<DirectionalChannel>:UPPer:STATe <state>

Enables or disables the checking of the upper limit.

Suffix:

<Measurement> 1...100

<DirectionalChannel> 1..2

Parameters:

<state> *RST: OFF

Manual operation: See ["Forward Upper Limit State, Reflection Upper Limit State"](#) on page 49**CALCulate<Measurement>:LIMit<DirectionalChannel>:UPPer[:DATA]:CCDF**
<value>

Upper limit value for CCDF.

Suffix:

<Measurement> 1...100

<DirectionalChannel> 1..2

Parameters:<value> Range: 0.0 to 100.0
*RST: 100.0
Default unit: pct**Manual operation:** See ["Forward Upper Limit, Reflection Upper Limit"](#) on page 49**CALCulate<Measurement>:LIMit<DirectionalChannel>:UPPer[:DATA]:RATio:**
RCoefficient <value>

Upper limit value for reflection coefficient.

Suffix:

<Measurement> 1...100

<DirectionalChannel> 1..2

Parameters:<value> Range: -1e18 to 1e18
*RST: 5.0
Default unit: -**Manual operation:** See ["Forward Upper Limit, Reflection Upper Limit"](#) on page 49**CALCulate<Measurement>:LIMit<DirectionalChannel>:UPPer[:DATA]:RATio:**
RFRatio <value>

Upper limit value for ratio of forward/reverse power.

Suffix:

<Measurement> 1...100

<DirectionalChannel> 1..2

Parameters:

<value> Range: 0.0 to 100.0
 *RST: 100.0
 Default unit: pct

Manual operation: See "[Forward Upper Limit, Reflection Upper Limit](#)" on page 49

**CALCulate<Measurement>:LIMit<DirectionalChannel>:UPPer[:DATA]:RATio:
 RLOsS <value>**

Upper limit value for return loss.

Suffix:

<Measurement> 1...100
 <DirectionalChannel> 1..2

Parameters:

<value> Range: -200.0 to 200.0
 *RST: 200.0
 Default unit: dB

Manual operation: See "[Forward Upper Limit, Reflection Upper Limit](#)" on page 49

**CALCulate<Measurement>:LIMit<DirectionalChannel>:UPPer[:DATA]:RATio:SWR
 <value>**

Upper limit value for SWR.

Suffix:

<Measurement> 1...100
 <DirectionalChannel> 1..2

Parameters:

<value> Range: 0.0 to 1e18
 *RST: 2.0
 Default unit: -

Manual operation: See "[Forward Upper Limit, Reflection Upper Limit](#)" on page 49

**CALCulate<Measurement>:LIMit<DirectionalChannel>:UPPer[:DATA]:RATio[:
 VALue] <value>**

Upper limit value for power ratio.

Suffix:

<Measurement> 1...100
 <DirectionalChannel> 1..2

Parameters:

<value> Range: 1e-18 to 1e18
 *RST: 100.0
 Default unit: -

Manual operation: See "[Forward Upper Limit, Reflection Upper Limit](#)" on page 49

CALCulate<Measurement>:LIMit<DirectionalChannel>:UPPer[:DATA][:POWER]
 <value>

Upper limit value for power value.

Suffix:

<Measurement> 1...100
 <DirectionalChannel> 1..2

Parameters:

<value> Range: 1e-15 to 1e12
 *RST: 1e-2
 Default unit: W

Manual operation: See "[Forward Upper Limit, Reflection Upper Limit](#)" on page 49

CALCulate<Measurement>:METer<DirectionalChannel>:LOWer[:DATA]:CCDF
 <value>

Lower limit value for CCDF bargraph display.

Suffix:

<Measurement> 1...100
 <DirectionalChannel> 1..2

Parameters:

<value> Range: 0.0 to 100.0
 *RST: 0.0
 Default unit: pct

Manual operation: See "[Forward Scale Lower Limit, Reflection Scale Lower Limit](#)" on page 41

CALCulate<Measurement>:METer<DirectionalChannel>:LOWer[:DATA]:RATio:
RCoefficient <value>

Lower limit value for reflection coefficient bargraph display.

Suffix:

<Measurement> 1...100
 <DirectionalChannel> 1..2

Parameters:

<value> Range: -1e18 to 1e18
 *RST: 1.0
 Default unit: -

Manual operation: See "[Forward Scale Lower Limit, Reflection Scale Lower Limit](#)" on page 41

**CALCulate<Measurement>:METer<DirectionalChannel>:LOWER[:DATA]:RATio:
 RFRatio <value>**

Lower limit value for ratio of forward/reverse power bargraph display.

Suffix:

<Measurement> 1...100

<DirectionalChannel> 1..2

Parameters:

<value> Range: 0.0 to 100.0
 *RST: 0.0
 Default unit: pct

Manual operation: See "[Forward Scale Lower Limit, Reflection Scale Lower Limit](#)" on page 41

**CALCulate<Measurement>:METer<DirectionalChannel>:LOWER[:DATA]:RATio:
 RLOSs <value>**

Lower limit value for return loss bargraph display.

Suffix:

<Measurement> 1...100

<DirectionalChannel> 1..2

Parameters:

<value> Range: -200.0 to 200.0
 *RST: -200.0
 Default unit: dB

Manual operation: See "[Forward Scale Lower Limit, Reflection Scale Lower Limit](#)" on page 41

**CALCulate<Measurement>:METer<DirectionalChannel>:LOWER[:DATA]:RATio:
 SWR <value>**

Lower limit value for SWR bargraph display.

Suffix:

<Measurement> 1...100

<DirectionalChannel> 1..2

Parameters:

<value> Range: 0.0 to 1e18
 *RST: 1.0
 Default unit: -

Manual operation: See "[Forward Scale Lower Limit, Reflection Scale Lower Limit](#)" on page 41

CALCulate<Measurement>:METer<DirectionalChannel>:LOWer[:DATA]:RATio[:VALue] <value>

Lower limit value for power ratio bargraph display.

Suffix:

<Measurement> 1...100

<DirectionalChannel> 1..2

Parameters:

<value> Range: 1e-18 to 1e18
 *RST: 1e-2
 Default unit: -

Manual operation: See "[Forward Scale Lower Limit, Reflection Scale Lower Limit](#)" on page 41

CALCulate<Measurement>:METer<DirectionalChannel>:LOWer[:DATA][:POWer] <value>

Lower limit value for power value bargraph display.

Suffix:

<Measurement> 1...100

<DirectionalChannel> 1..2

Parameters:

<value> Range: 1e-15 to 1e12
 *RST: 1e-9
 Default unit: W

Manual operation: See "[Forward Scale Lower Limit, Reflection Scale Lower Limit](#)" on page 41

CALCulate<Measurement>:METer<DirectionalChannel>:UPPer[:DATA]:CCDF <value>

Upper limit value for CCDF bargraph display.

Suffix:

<Measurement> 1...100

<DirectionalChannel> 1..2

Parameters:

<value> Range: 0.0 to 100.0
 *RST: 100.0
 Default unit: pct

Manual operation: See "[Forward Scale Upper Limit, Reflection Scale Upper Limit](#)"
 on page 42

**CALCulate<Measurement>:METer<DirectionalChannel>:UPPer[:DATA]:RATio:
 RCOefficient <value>**

Upper limit value for reflection coefficient bargraph display.

Suffix:

<Measurement> 1...100

<DirectionalChannel> 1..2

Parameters:

<value> Range: -1e18 to 1e18
 *RST: 5.0
 Default unit: -

Manual operation: See "[Forward Scale Upper Limit, Reflection Scale Upper Limit](#)"
 on page 42

**CALCulate<Measurement>:METer<DirectionalChannel>:UPPer[:DATA]:RATio:
 RFRatio <value>**

Upper limit value for ratio of forward/reverse power bargraph display.

Suffix:

<Measurement> 1...100

<DirectionalChannel> 1..2

Parameters:

<value> Range: 0.0 to 100.0
 *RST: 100.0
 Default unit: pct

Manual operation: See "[Forward Scale Upper Limit, Reflection Scale Upper Limit](#)"
 on page 42

**CALCulate<Measurement>:METer<DirectionalChannel>:UPPer[:DATA]:RATio:
 RLOSs <value>**

Upper limit value for return loss bargraph display.

Suffix:

<Measurement> 1...100

<DirectionalChannel> 1..2

Parameters:

<value> Range: -200.0 to 200.0
 *RST: 200.0
 Default unit: dB

Manual operation: See "[Forward Scale Upper Limit, Reflection Scale Upper Limit](#)" on page 42

**CALCulate<Measurement>:METer<DirectionalChannel>:UPPer[:DATA]:RATio:
 SWR <value>**

Upper limit value for SWR bargraph display.

Suffix:

<Measurement> 1...100

<DirectionalChannel> 1..2

Parameters:

<value> Range: 0.0 to 1e18
 *RST: 2.0
 Default unit: -

Manual operation: See "[Forward Scale Upper Limit, Reflection Scale Upper Limit](#)" on page 42

**CALCulate<Measurement>:METer<DirectionalChannel>:UPPer[:DATA]:RATio[:
 VALue] <value>**

Upper limit value for power ratio bargraph display.

Suffix:

<Measurement> 1...100

<DirectionalChannel> 1..2

Parameters:

<value> Range: 1e-18 to 1e18
 *RST: 100.0
 Default unit: -

Manual operation: See "[Forward Scale Upper Limit, Reflection Scale Upper Limit](#)" on page 42

**CALCulate<Measurement>:METer<DirectionalChannel>:UPPer[:DATA][:POWER]
 <value>**

Upper limit value for power value bargraph display.

Suffix:

<Measurement> 1...100

<DirectionalChannel> 1..2

Parameters:

<value> Range: 1e-15 to 1e12
 *RST: 1e-2
 Default unit: W

Manual operation: See "[Forward Scale Upper Limit, Reflection Scale Upper Limit](#)" on page 42

CALCulate<Measurement>:RELative<DirectionalChannel>:CCDF <value>

Relative limit value for CCDF.

Suffix:

<Measurement> 1...100
 <DirectionalChannel> 1..2

Parameters:

<value> Range: 0.0 to 100.0
 *RST: 50.0
 Default unit: pct

Manual operation: See "[Forward Reference Value, Reflection Reference Value](#)" on page 41

CALCulate<Measurement>:RELative<DirectionalChannel>:POWer <value>

Relative limit value for power.

Suffix:

<Measurement> 1...100
 <DirectionalChannel> 1..2

Parameters:

<value> Range: 1e-15 to 1e12
 *RST: 1e-3
 Default unit: W

Manual operation: See "[Forward Reference Value, Reflection Reference Value](#)" on page 41

CALCulate<Measurement>:RELative<DirectionalChannel>:RATio:RCOefficient <value>

Relative value for reflection coefficient.

Suffix:

<Measurement> 1...100
 <DirectionalChannel> 1..2

Parameters:

<value> Range: 0.0 to 1.0
 *RST: 0.5
 Default unit: -

Manual operation: See "[Forward Reference Value, Reflection Reference Value](#)" on page 41

CALCulate<Measurement>:RELative<DirectionalChannel>:RATio:RFRatio
 <value>

Relative value for ratio of forward/reverse power.

Suffix:

<Measurement> 1...100

<DirectionalChannel> 1..2

Parameters:

<value> Range: 0.0 to 100.0
 *RST: 50.0
 Default unit: pct

Manual operation: See "[Forward Reference Value, Reflection Reference Value](#)" on page 41

CALCulate<Measurement>:RELative<DirectionalChannel>:RATio:RLOSs <value>

Relative value for return loss.

Suffix:

<Measurement> 1...100

<DirectionalChannel> 1..2

Parameters:

<value> Range: -200.0 to 200.0
 *RST: 0.0
 Default unit: dB

Manual operation: See "[Forward Reference Value, Reflection Reference Value](#)" on page 41

CALCulate<Measurement>:RELative<DirectionalChannel>:RATio:SWR <value>

Relative value for SWR.

Suffix:

<Measurement> 1...100

<DirectionalChannel> 1..2

Parameters:

<value> Range: 0.0 to 1.0
 *RST: 0.5
 Default unit: -

Manual operation: See "[Forward Reference Value, Reflection Reference Value](#)" on page 41

CALCulate<Measurement>:RELative<DirectionalChannel>:RATio[:VALue]
 <value>

Relative value for power ratio.

Suffix:

<Measurement> 1...100

<DirectionalChannel> 1..2

Parameters:

<value> Range: 1e-18 to 1e18
 *RST: 1.0
 Default unit: -

Manual operation: See "[Forward Reference Value, Reflection Reference Value](#)" on page 41

CALCulate<Measurement>:RELative<DirectionalChannel>[:STATE] <state>

DirectionalChannel means Forward and Reverse.

Suffix:

<Measurement> 1...100

<DirectionalChannel> 1..2

Parameters:

<state> OFF | ON | SET
 *RST: OFF

Manual operation: See "[Forward Relative State, Reflection Relative State](#)" on page 41

CALCulate<Measurement>:RESolution <resolution>

Selects the result resolution. This affects both the display resolution as well as resolution settings for the sensor(s).

Suffix:

<Measurement> 1...100

Parameters:

<resolution> I | OI | OOI | OOOI
 *RST: OOI

Manual operation: See ["Resolution"](#) on page 47

CALCulate<Measurement>[:CHANnel<Channel>]:AVERage:COUNT:AUTO[:STATE] <state>

Enables or disables the mode for determining the Average Count automatically from the level of the input signal.

Suffix:

<Measurement> 1...100

<Channel> 1...2

Parameters:

<state> *RST: ON

Manual operation: See ["Averaging Mode"](#) on page 56

CALCulate<Measurement>[:CHANnel<Channel>]:AVERage:COUNT[:VALue] <value>

Sets the filter length i.e. the number of readings to be averaged for one measured value. The higher the count the lower the noise and the longer it takes to obtain a measured value.

Suffix:

<Measurement> 1...100

<Channel> 1...2

Parameters:

<value> Range: 1 to 256
*RST: 4

Manual operation: See ["Averaging Count"](#) on page 56

CALCulate<Measurement>[:CHANnel<Channel>]:CORRection:OFFSet:RPLane <plane>

Selects the source (SOURce) or the load (LOAD) port as the reference plane for measurements.

Suffix:

<Measurement> 1...100

<Channel> 1...2

Parameters:

<plane> SOURce | LOAD
*RST: SOURce

Manual operation: See ["Offset Reference Plane"](#) on page 53

CALCulate<Measurement>[:CHANnel<Channel>]:CORRection:OFFSet:STATE
<state>

Enables or disables a selected frequency dependent offset table per channel.

Suffix:

<Measurement> 1...100

<Channel> 1...2

Parameters:

<state> *RST: OFF

Manual operation: See "[Offset](#)" on page 53

CALCulate<Measurement>[:CHANnel<Channel>]:CORRection:OFFSet[:
MAGNitude] <value>

Sets an offset correction value for the selected reference plane. This can correct the influence of cables etc. and does not influence measurement accuracy.

Suffix:

<Measurement> 1...100

<Channel> 1...2

Parameters:

<value> Range: -200.0 to 200.0

*RST: 0.0

Default unit: dB

Manual operation: See "[Offset](#)" on page 53

CALCulate<Measurement>[:CHANnel<Channel>]:FEED <function>

Select the measurement function for a given channel.

Suffix:

<Measurement> 1...100

<Channel> 1...2

Parameters:

<function> *RST: POWER:FORWARD:AVERAGE

Manual operation: See ["Average"](#) on page 38
 See ["CCDF"](#) on page 38
 See ["Peak Envelope Power \(PEP\)"](#) on page 38
 See ["Absorption Average"](#) on page 38
 See ["Crest Factor \(CF\)"](#) on page 38
 See ["Absorption PEP"](#) on page 39
 See ["Burst Average"](#) on page 39
 See ["Absorption Burst"](#) on page 39
 See ["Off"](#) on page 39
 See ["Reverse Power"](#) on page 39
 See ["Standing Wave Ratio \(SWR\)"](#) on page 40
 See ["Return Loss"](#) on page 40
 See ["Reflection Coefficient"](#) on page 40
 See ["Reflection Ratio"](#) on page 40

CALCulate<Measurement>[:CHANnel<Channel>]:NRT:APERture:MODE <mode>

Selects a user-defined value (USER) or the default (DEFault) value for the integration time.

Suffix:

<Measurement> 1...100

<Channel> 1...2

Parameters:

<mode> DEFault | USER
 *RST: DEFault

Manual operation: See ["Integration Time Mode"](#) on page 55

CALCulate<Measurement>[:CHANnel<Channel>]:NRT:APERture[:VALue] <value>

Defines the integration time if the `Aperture` mode is set to USER.

Suffix:

<Measurement> 1...100

<Channel> 1...2

Parameters:

<value> Range: 0.005 to 0.111
 *RST: 0.037
 Default unit: s

Manual operation: See ["Integration Time"](#) on page 56

CALCulate<Measurement>[:CHANnel<Channel>]:NRT:BURSt:MODE <mode>

Defines the mode for average burst power results, either calculated (USER) or measured (AUTO).

Suffix:

<Measurement> 1...100

<Channel> 1...2

Parameters:

<mode> AUTO | USER

*RST: AUTO

Manual operation: See "[Burst Mode](#)" on page 51**CALCulate<Measurement>[:CHANnel<Channel>]:NRT:BURSt:PERiod <value>**

Period of a burst sequence (for selected burst USER mode).

Suffix:

<Measurement> 1...100

<Channel> 1...2

Parameters:

<value> Range: 0.0 to 1.0

*RST: 0.1

Default unit: s

Manual operation: See "[Burst Period](#)" on page 51**CALCulate<Measurement>[:CHANnel<Channel>]:NRT:BURSt:WIDTh <value>**

Burst width (for selected burst USER mode).

Suffix:

<Measurement> 1...100

<Channel> 1...2

Parameters:

<value> Range: 0.0 to 1.0

*RST: 0.01

Default unit: s

Manual operation: See "[Burst Width](#)" on page 51**CALCulate<Measurement>[:CHANnel<Channel>]:NRT:CCDF:THReshold <value>**

Defines a threshold power level used for CCDF, where the probability is measured that the envelope power exceeds a given threshold.

Suffix:

<Measurement> 1...100

<Channel> 1...2

Parameters:

<value> Range: 0.0 to 100e6
 *RST: 0.001
 Default unit: W

Manual operation: See "[CCDF Threshold](#)" on page 52

CALCulate<Measurement>[:CHANnel<Channel>]:NRT:DIRection <direction>

Selects the direction of forward power relative to defined ports 1 and 2. In *AUTO* mode the port with the greater measured power is interpreted as forward power.

Suffix:

<Measurement> 1...100
 <Channel> 1...2

Parameters:

<direction> AUTO | FORWard | REVerse
 *RST: AUTO

Manual operation: See "[Direction](#)" on page 52

CALCulate<Measurement>[:CHANnel<Channel>]:NRT:DMODulation:WCDMA:CRATe <value>

Defines the WCDMA chip-rate.

Suffix:

<Measurement> 1...100
 <Channel> 1...2

Parameters:

<value> Range: 0.0 to 8.2e6
 *RST: 1.0e6
 Default unit: Hz

Manual operation: See "[WCDMA Chip Rate](#)" on page 54

CALCulate<Measurement>[:CHANnel<Channel>]:NRT:DMODulation[:VALue] <modulation>

Selects a certain communication standard for the modulation correction.

Suffix:

<Measurement> 1...100
 <Channel> 1...2

Parameters:

<modulation> OFF | IS95 | WCDMA | DVBT | DAB
 *RST: OFF

Manual operation: See ["Modulation"](#) on page 53

CALCulate<Measurement>[:CHANnel<Channel>]:NRT:PEP:HOLD:TIME <value>

Specifies the hold time of the peak hold circuit. If the entry is valid, the USER mode is automatically switched on and the default setting is switched off.

Suffix:

<Measurement> 1...100

<Channel> 1...2

Parameters:

<value> Range: 1e-3 to 1e-1
 *RST: 0.01
 Default unit: s

Manual operation: See ["PEP Hold Time"](#) on page 52

CALCulate<Measurement>[:CHANnel<Channel>]:NRT:VBWidth[:VALue] <value>

Selects a certain video bandwidth filter (0..2). The actual filter bandwidth is sensor specific. For example [4 kHz, 200 kHz, 600 kHz] for NRT-Z14 or [4 kHz, 200 kHz, 4 MHz] for NRT-Z43/-Z44.

Suffix:

<Measurement> 1...100

<Channel> 1...2

Parameters:

<value> Range: 0 to 2
 *RST: 2

Manual operation: See ["Video Bandwidth"](#) on page 55

CALCulate<Measurement>:LIMit[:STATe] <state>

These commands are used to start (ON) or stop (OFF) the search for the min/max values, which cover the measurement functions set under subsystem SENSE<n>: FUNCTION[:ON] <measurement function>. The min/max memories are automatically reset upon start. During a search for the max/min values, the value set under subsystem CALCulate<n>:LIMit:TYPE (maximum, minimum or the difference thereof) is returned to a request for data, not however the currently measured value. The request for data is in the form of the query SENSE<n>: DATA?.

Suffix:

<Measurement> 1...100

Parameters:

<state> ON | OFF
 *RST: OFF

Example: CALC1:LIM ON

CALCulate<Measurement>:LIMit:TYPE <type>

The command allows selection of the value to be output.

Suffix:

<Measurement> 1...100
xxx

Parameters:

<type> MAX | MIN | DIFFerence
MAXimum
Maximum value
MINimum
Minimum value
DIFFerence
Difference between maximum and minimum value
*RST: MAX

Example: CALC1:LIM:TYPE MAX

11.5 CALibration

[CALibration<Sensor>:ZERO](#)..... 130

CALibration<Sensor>:ZERO

This command causes zeroing to be carried out for the sensor connected to port <sensor>. No RF power shall be applied to the sensor during zeroing.

Zeroing must be completed before a new measurement can be started. The command *WAI allows to recognize the end of a zeroing procedure.

Example: CAL2:ZERO

Usage: Event

11.6 DIAGnostic

[DIAGnostic:INFO:OTIMe?](#)..... 130

DIAGnostic:INFO:OTIMe?

This command returns the count of the built-in elapsed-time meter. The count is always output in hours [h] and cannot be changed from outside.

The command is in the form of a query and therefore has no *RST value.

Example: DIAG:INFO:OTIM?

Usage: Query only

11.7 FORMat

FORMat:SREGister.....	131
FORMat[:DATA].....	131

FORMat:SREGister <register>

Specifies which format is used for the return value of *STB?.

Parameters:

<register> ASCII | HEXadecimal | OCTal | BINary
 *RST: ASCII

Example: FORM:SREG ASC

FORMat[:DATA] [<data,length>, <length>]

Specifies whether numeric data is sent as block data in binary form (REAL) or as character strings in plain text (ASCII). Also specifies the length.

Parameters:

<data,length> ASCII | REAL
 *RST: ASCII

<length> Range: 0 to 64
 *RST: 0

Example: FORM ASC,12

11.8 FREQUENCY

FREQUENCY<Sensor>.....	131
------------------------	-----

FREQUENCY<Sensor> <value>

Sets the carrier frequency of the applied signal. This corrects any frequency- dependent effects introduced by the sensor. If the sensor is to reach the specified measurement accuracy, the signal frequency must be entered.

Parameters:

<value> Default unit: Hz

11.9 INPut

INPut<Sensor>:PORT:OFFSet.....	132
INPut<Sensor>:PORT:POSition.....	132
INPut<Sensor>:PORT:SOURce[:VALue].....	132
INPut<Sensor>:PORT:SOURce:AUTO.....	133

INPut<Sensor>:PORT:OFFSet <offs>

This command allows the transmission loss in a cable connecting the desired measurement point and the sensor to be taken into account. If the measurement position is set to LOAD, i.e. INPut<n>:PORT:POSition LOAD, the cable is assumed to be connected between the sensor and the load, otherwise between the sensor and the source.

Parameters:

<offs> Range: 0.0 to 100.0
 *RST: 0.0
 Default unit: dB

Example: INP1:PORT:OFFS 1.25

Manual operation: See "Offset" on page 53

INPut<Sensor>:PORT:POSition <pos>

This command selects the reference plane. It defines the sensor port to which the measurement results are to be referred to.

Parameters:

<pos> SOURce | LOAD
 SOURce
 Referred to source.
 LOAD
 Referred to load.
 *RST: SOURce

Example: INP2:PORT:POS SOUR

Manual operation: See "Offset Reference Plane" on page 53

INPut<Sensor>:PORT:SOURce[:VALue] <val>

Defines the forward direction for the given input if the automatic assignment has been switched off by INPut{Sensor{1...128}}:PORT:SOURce:AUTO OFF.

Parameters:

<val> Range: 1 to 2
 *RST: 1

Manual operation: See "Direction" on page 52

INPut<Sensor>:PORT:SOURce:AUTO <auto>

This command switches the automatic assignment of the forward direction on or off.

Parameters:

<auto>	ON With automatic assignment of the forward direction, the direction in which the greater power flows is taken as the forward direction.
	OFF If the automatic assignment is switched off, e.g. to obtain a clear assignment in the case that forward and reverse power are almost equal, the orientation of the sensor is to be defined with the <code>INPut<Sensor>:PORT:SOURce</code> command.

*RST: 0

Example: `INP2:PORT:SOUR:AUTO OFF`

Manual operation: See "[Direction](#)" on page 52

11.10 MMEMory

MMEMory:ALlases?	134
MMEMory:ATTRibute	134
MMEMory:CATalog?	135
MMEMory:CATalog:LENGth?	135
MMEMory:CDIRectory	136
MMEMory:COPI	136
MMEMory:DATA	136
MMEMory:DCATalog?	137
MMEMory:DCATalog:LENGth?	138
MMEMory:DELe	138
MMEMory:DRIVes?	138
MMEMory:LOAD:ITEM	138
MMEMory:LOAD:MACRo	139
MMEMory:LOAD:STATe	139
MMEMory:MDIRectory	139
MMEMory:MOVE	140
MMEMory:MSIS	140
MMEMory:RCL	140
MMEMory:SAV	140
MMEMory:RDIRectory	141
MMEMory:STORe:ITEM	141
MMEMory:STORe:MACRo	141
MMEMory:STORe:STATe	141

MMEMory:Aliases? {<alias>, <path>}...

Reads the current list of predefined path aliases to be used with the MMEM commands. In case there are no aliases defined, a single empty string is returned.

Return values:

<alias> The token to be used instead of a given path.

<path> The path that is expanded in MMEM commands for the associated alias definition.

Usage: Query only

MMEMory:ATTRibute <path_name>, <attributes>**MMEMory:ATTRibute?** <path_name>

This instruction permits a setting and/or a resetting of file attributes.

The indication of path depends on Windows conventions for file names and can contain Wildcards.

Note: This commands is limited to files (does not function for listings).

Setting parameters:

<attributes> String, which contains the information for the setting/resetting of attributes.

+

Sets an attribute.

Permissible syntax of the string for the setting/deletion of attributes: For everyone of the attributes which can be treated must be placed in front his letter "+" for setting and/or "-" for deletion.

-

Deletes an attribute.

R

Attribute for write protected file.

A

Attribute for archiving file.

S

Attribute for system file.

H

Attribute for hid file.

*RST: -

Parameters for setting and query:

<path_name> Path indication

Return values:

<file_entry> Response string containing <file_name>,<attributes>

Example:

```
MMEM:ATTR 'D:\USER\DATA\*.LOG', '-R -A'
```

Deletes the attribute for write protected file and the attribute for archiving file for all *.LOG files in the D:\USER\DATA directory.

Example: `MMEM:ATTR? 'D:\USER\DATA*.*'`
Returns a list of all files and their attributes in the D:\USER\DATA directory.

MMEMory:CATalog? <path_name>[, <format>]

Returns the subdirectories and files in the specified directory. If no directory and no drive are specified, the subdirectories and files in the default directory on the default drive are returned.

Query parameters:

<path_name>

<format> ALL | WTime

Return values:

<used_memory> Response string: used bytes in this directory

<free_memory>

<file_entry> Response string: "<file_name>,<file_type>,<filesize_in_bytes>"

Example: `MMEM:CAT? '\\Server\DATA*.LOG'`
Returns all files in the \\Server\DATA directory with the *.LOG extension.

Example: `MMEM:CAT? 'D:\user'`
Returns all files at the highest directory level of the memory stick.
127145265,175325184, "test,DIR,0",
"temp,DIR,0", "readme.txt,ASC,1324",
"state.savracl,STAT,5327", "waveform.wv,BIN,2342"
Response: The D:\user directory contains the test and temp subdirectories as well as the readme.txt, state.savracl and waveform.wv files which have different file types.

Usage: Query only

MMEMory:CATalog:LENGth? [<path_name>]

Returns the number of files in the specified directory. If no directory and no drive are specified, the number of files in the default directory on the default drive are returned.

Query parameters:

<path_name>

Return values:

<count>

Example: `MMEM:CAT:LENG? 'E:\'`
 Returns the number of files at the highest directory level of the memory stick.
 1
 Response: There is 1 file at the highest directory level of the memory stick.

Usage: Query only

MMEMory:CDIRectory [<directory_name>]
MMEMory:CDIRectory? [<directory_name>]

Changes the default directory. This directory is used for all `MMEM` commands if no path is specified. It is also possible to change to a higher directory using two dots '..'.

Parameters:

<directory_name> *RST: D:\

Example: `MMEM:CDIR 'test'`
 Changes from the current directory level to the `test` subdirectory.

MMEMory:COPY <file_source>[, <file_destination>]

Copies the specified file or directory (first parameter) to the specified destination (second parameter).

Setting parameters:

<file_source>

<file_destination> If the file destination not specified, <file_source> is copied to the default directory on the default drive. Files with the same name that already exist in the destination directory are overwritten without an error message.

Example: `MMEM:COPY 'D:\user\test1.savrcl', 'E:'`
 Copies the `test1.savrcl` file in the `user` directory on the `D:` drive to the memory stick without changing the file name.

Usage: Setting only

MMEMory:DATA <file_name>, <data>[, <append>]
MMEMory:DATA? <file_name>

Writes the <data> to the file identified by <file_name>. The IEC/IEEE bus terminator should be set to EOI in order to ensure correct data transfer.

The associated query transfers the specified file from the R&S NRT2 to the control computer. Make sure that the intermediate memory on the control computer is large enough to receive the file. In this case, the setting for the IEC/IEEE bus terminator is irrelevant.

This command can be used to read or transfer stored instrument settings or waveforms directly from/to the instrument.

Parameters:

<data> <block>

The binary data block has the following structure:

```
#234<block_data>
#
<number>
<number>
<block data>
```

Always comes first in the binary block.

<number>
Indicates how many digits the subsequent length entry has (2 in example).

<number>
Indicates the number of subsequent bytes (34 in example).

<block data>
Block data for the specified length.

*RST: -

Setting parameters:

<append> APPend

Parameters for setting and query:

<file_name>

Example: "MMEM:DATA 'TEST1.WV',#3767<block_data>"
Writes the block data to the test1.wv file.
MMEM:DATA? 'TEST1.WV'
Sends the data of the Test1.wv file from the R&S NRT2 to the control computer in the form of a binary block.

MMEMory:DCATalog? [<path_name>]

Returns the subdirectories of the specified directory in a list. The subdirectory names are separated by commas. If no directory is specified, the default directory is read out.

Query parameters:

<path_name>

Return values:

<file_entry> Response string: subdirectory name

Example:

MMEM:DCAT?

Returns the subdirectories of the default directory.

'test', 'wave', 'digital'

Response: The test, wave and digital subdirectories exist in the default directory.

Usage:

Query only

MMEMory:DCATalog:LENGth? [<path_name>]

Returns the number of subdirectories in the specified directory. If no directory is specified, the default directory is read out.

Query parameters:

<path_name>

Return values:

<file_entry_count> Response string: number of subdirectories.

Example:

MMEM:DCAT:LENG

Returns the number of subdirectories in the current directory.

3

Response: There are 3 subdirectories in the current directory.

Usage: Query only

MMEMory:DELeTe <file_name>

Deletes the specified file.

Setting parameters:

<file_name>

Example:

MMEM:DEL 'D:\user\test1.savrc1'

Deletes the test1.savrc1 file in the user directory on the internal hard disk.

Usage: Setting only

MMEMory:DRIVes?

Returns a list of the logical drive assembly designators.

Return values:

<drive>

Example:

MMEM:DRIVes?

"A:\", "C:\", "D:\", "E:\", "H:\", "I:\", "J:\", "K:\", "M:\", "N:\", "O:\", "P:\", "Q:\", "S:\", "T:\", "U:\", "V:\", "W:\", "X:\", "Y:\", "Z:\"

Response: List of the drive assemblies.

Usage: Query only

MMEMory:LOAD:ITEM <item_path>, <file_name>

Loads a specific part of a system application. This is also called a partial recall.

Setting parameters:

<item_path>

<file_name>

Usage: Setting only

MMEMory:LOAD:MACRo <label>, <file_name>[, <msus>]

Loads a remote macro from file.

Setting parameters:

<label>

<file_name>

<msus>

Usage: Setting only

MMEMory:LOAD:STATe <sav_rcl_state_number>, <file_name>[, <msus>]

Loads the specified file stored under the specified name in an internal memory.

The *RCL command is used to load the immediate instrument setting.

Setting parameters:

<sav_rcl_state_number> the instrument setting of the selected file is set directly in the R&S NRT2.
 ≠ 0: load the intermediate instrument setting using *RCL (for details see example).

<file_name>

<msus>

Example: MMEM:LOAD:STAT 0, 'D:\user\test1.savrcl'
 Loads the test1.savrcl file in the user directory of the internal hard disk and activates the associated instrument setting.

Example: MMEM:STOR:STAT 4, 'D:\user\test4.savrcl'
 Saves the test4.savrcl file in the user directory of the internal hard disk.

MMEM:LOAD:STAT 4, 'D:\user\test4.savrcl'
 Loads the test4.savrcl file in the user directory of the internal hard disk.
 *RCL 4
 Activates the instrument setting of the test4.savrcl file.

Usage: Setting only

MMEMory:MDIRectory <directory_name>

Creates a new subdirectory or a directory tree in the specified directory. If no directory is specified, the subdirectory/directory tree is created in the default directory.

Setting parameters:

<directory_name>

Example: `MMEM:MDIR 'carrier'`
Creates the `carrier` subdirectory in the default directory.

Usage: Setting only

MMEMory:MOVE <file_source>, <file_destination>

If no path is specified for <file_destination>, renames <file_source>.

If a path is specified for <file_destination>, moves <file_source> to the specified path and stores it under its original file name or, if specified, under a new file name.

Setting parameters:

<file_source> File that is moved and/or renamed.

<file_destination> File destination and, if you want to rename the file, new file name.

Example: `MMEM:MOVE 'test1.savrcl', 'keep1.savrcl'`
Renames the `test1.savrcls` file as `keep1.savrcl`.
`MMEM:MOVE 'test1.savrcl', '\test\keep1.savrcl'`
Moves the `test1.savrcls` file to the `test` subdirectory and stores it there under the name `keep1.savrcl`.

Usage: Setting only

MMEMory:MSIS [<msus>]

Sets the drive or network resource in the case of networks (MSIS = mass storage identification string). This setting is effective for all MMEMory commands where the drive is not explicitly specified.

Parameters:

<msus> *RST: D:\

Example: `MMEM:MSIS 'E:'`
Selects the memory stick as the default drive.

MMEMory:RCL <file_name>[, <msus>]

Setting parameters:

<file_name>

<msus>

Usage: Setting only

MMEMory:SAV <file_name>[, <msus>]

Saves directly to a file. This is an alternative to `*SAV <num>MMEM:STOR:STAT <num>, <filename>`.

Setting parameters:

<file_name>

<msus>

Usage: Setting only**MMEMory:RDIRectory** <directory_name>

Deletes the specified subdirectory in the specified directory. If no directory is specified, the specified subdirectory is deleted in the default directory.

Setting parameters:

<directory_name>

Example:

MMEM:RDIR 'carrier'

Deletes the `carrier` subdirectory in the default directory.**Usage:** Setting only**MMEMory:STORE:ITEM** <item_name>, <file_name>

Implements the partial save of specific application data.

Setting parameters:

<item_name>

<file_name>

Usage: Setting only**MMEMory:STORE:MACRo** <label>, <file_name>[, <msus>]

Store remote macro definition to file.

Setting parameters:

<label>

<file_name>

<msus>

Usage: Setting only**MMEMory:STORE:STATe** <sav_rcl_state_number>, <file_name>[, <msus>]

Saves the current instrument setting in the specified file.

Setting parameters:

<sav_rcl_state_number>: the current instrument setting is stored directly in the specified file.

≠ 0: save the intermediate instrument setting using `*SAV` (for details see example).

<file_name>

<msus>

Example: MMEM:STOR:STAT 0, 'D:\USER\TEST1.ss'
Saves the current instrument setting in the TEST1.ss file in the USER directory on the internal hard disk.

Example: MMEM:STOR:STAT 4, 'D:\user\test4.savrcl'
*SAV 4
Saves the test4.savrcl file in the user directory of the internal hard disk.

Usage: Setting only

11.11 OUTPut

OUTPut:LIMit:FAIL.....	142
OUTPut:MODE<output>.....	142
OUTPut:REcorder<output>:LIMit:LOWer:RATio[:VALue].....	143
OUTPut:REcorder<output>:LIMit:LOWer[:POWer].....	144
OUTPut:REcorder<output>:LIMit:UPPer:RATio[:VALue].....	144
OUTPut:REcorder<output>:LIMit:UPPer[:POWer].....	144
OUTPut:REcorder<output>:LIMit:LOWer:CCDF.....	145
OUTPut:REcorder<output>:LIMit:LOWer:RATio:RCoefficient.....	145
OUTPut:REcorder<output>:LIMit:LOWer:RATio:RFRatio.....	145
OUTPut:REcorder<output>:LIMit:LOWer:RATio:RLOSs.....	145
OUTPut:REcorder<output>:LIMit:LOWer:RATio:SWR.....	146
OUTPut:REcorder<output>:LIMit:UPPer:CCDF.....	146
OUTPut:REcorder<output>:LIMit:UPPer:RATio:RCoefficient.....	146
OUTPut:REcorder<output>:LIMit:UPPer:RATio:RFRatio.....	147
OUTPut:REcorder<output>:LIMit:UPPer:RATio:RLOSs.....	147
OUTPut:REcorder<output>:LIMit:UPPer:RATio:SWR.....	147

OUTPut:LIMit:FAIL <mode>

Specifies the value which should be applied to output 1 if the measured value causes a limit violation and the output is in TTL mode (OUTPut:MODE<output> on page 142).

Parameters:

<mode> LOW | HIGH
HIGH
Corresponds to an output voltage of 2.5 V, if a limit is violated.
*RST: LOW

Manual operation: See "Fail Voltage" on page 70

OUTPut:MODE<output> <mode>

Switches the operating mode of the I/O connector.

Connector 1 can be configured as analog output. Analog output may be a DA conversion of a measurement result or a signaling of a limit violation (0 V or 2.5 V).

Connector 2 can be configured as analog output or as trigger input.

Suffix:

<output> 1...2

Setting parameters:

<mode> OFF | REcorder | FREcorder | RREcorder | LIMit | FLIMit | RLIMit | TOUT | TIN

OFF

The connector is disabled.

FREcorder

The output voltage of the connector follows the forward power of the measurement.

RREcorder

The output voltage of the connector follows the reflection power of the measurement.

FLIMit

TTL mode of connector 1. Output is either 0 V or 2.5 V depending on the measured forward power and the setting of [OUTPut:LIMit:FAIL](#) on page 142 (connector 1 only).

RLIMit

TTL mode of connector 1. Output is either 0 V or 2.5 V depending on the measured reflection power and the setting of [OUTPut:LIMit:FAIL](#) on page 142 (connector 1 only).

TIN

Connector is configured as trigger input (connector 2 only).

*RST: OFF

Usage: Setting only

Manual operation: See "[Mode](#)" on page 69

OUTPut:REcorder<output>:LIMit:LOWer:RATio[:VALue] <value>

Specifies the lower power limit of the characteristic for one of the two analog outputs if the associated calculate block returns a power ratio (unit DB, DPCT or O) as the measured value.

Unit:DB | DPCT | O

Suffix:

<output> 1...2

Parameters:

<value> Range: 1e-18 to 1e18
*RST: 1.0
Default unit: -

Manual operation: See "[0 V Equivalent](#)" on page 69

OUTPut:RECOder<output>:LIMit:LOWer[:POWER] <lower_limit>

Specifies the lower power limit of the characteristic for one of the two analog outputs if the associated calculate block returns a power (unit DBM, W or DBUV) as measured value.

Units: DBM | W | DBUV

Suffix:

<output> 1...2

Parameters:

<value> Range: 1e-15 to 1e12
*RST: 1e-6
Default unit: W

Manual operation: See "[0 V Equivalent](#)" on page 69

OUTPut:RECOder<output>:LIMit:UPPer:RATio[:VALue] <value>

Specifies the upper power limit of the characteristic for one of the two analog outputs if the associated calculate block returns a power ratio (unit DB, DPCT or O) as the measured value.

Unit:DB | DPCT | O

Suffix:

<output> 1...2

Parameters:

<value> Range: 1e-18 to 1e18
*RST: 10.0
Default unit: -

Manual operation: See "[2.5 V Equivalent](#)" on page 70

OUTPut:RECOder<output>:LIMit:UPPer[:POWER] <value>

Specifies the upper power limit of the characteristic for one of the two analog outputs if the associated calculate block returns a power (unit DBM, W or DBUV) as the measured value.

Unit:DBM | W | DBUV

Suffix:

<output> 1...2

Parameters:

<value> Range: 1e-15 to 1e12
*RST: 1.0
Default unit: W

Manual operation: See "[2.5 V Equivalent](#)" on page 70

OUTPut:RECOder<output>:LIMit:LOWer:CCDF <value>

Specifies the lower limit of the characteristic for one of the two analog outputs. Below this limit, the output is set to 0 V.

Suffix:

<output> 1...2

Parameters:

<value> Range: -1e18 to 1e18
*RST: 0.0
Default unit: pct

Manual operation: See "[0 V Equivalent](#)" on page 69

OUTPut:RECOder<output>:LIMit:LOWer:RATio:RCOefficient <value>

Specifies the lower limit of the characteristic for one of the two analog outputs. Below this limit, the output is set to 0 V.

Suffix:

<output> 1...2

Parameters:

<value> Range: -1e18 to 1e18
*RST: 0.0
Default unit: -

Manual operation: See "[0 V Equivalent](#)" on page 69

OUTPut:RECOder<output>:LIMit:LOWer:RATio:RFRatio <value>

Specifies the lower limit of the characteristic for one of the two analog outputs. Below this limit, the output is set to 0 V.

Suffix:

<output> 1...2

Parameters:

<value> Range: -1e18 to 1e18
*RST: 0.0
Default unit: pct

Manual operation: See "[0 V Equivalent](#)" on page 69

OUTPut:RECOder<output>:LIMit:LOWer:RATio:RLOSs <value>

Specifies the lower limit of the characteristic for one of the two analog outputs. Below this limit, the output is set to 0 V.

Suffix:

<output> 1...2

Parameters:

<value> Range: -180.0 to 180.0
 *RST: 0.0
 Default unit: dB

Manual operation: See "[0 V Equivalent](#)" on page 69

OUTPut:RECOorder<output>:LIMit:LOWer:RATio:SWR <value>

Specifies the lower limit of the characteristic for one of the two analog outputs. Below this limit, the output is set to 0 V.

Suffix:

<output> 1...2

Parameters:

<value> Range: -1e18 to 1e18
 *RST: 1.0
 Default unit: -

Manual operation: See "[0 V Equivalent](#)" on page 69

OUTPut:RECOorder<output>:LIMit:UPPer:CCDF <value>

Specifies the upper limit of the characteristic for one of the two analog outputs. Above this limit, the output is set to 2.5 V.

Suffix:

<output> 1...2

Parameters:

<value> Range: -1e18 to 1e18
 *RST: 1.0
 Default unit: pct

Manual operation: See "[2.5 V Equivalent](#)" on page 70

OUTPut:RECOorder<output>:LIMit:UPPer:RATio:RCOefficient <value>

Specifies the upper limit of the characteristic for one of the two analog outputs. Above this limit, the output is set to 2.5 V.

Suffix:

<output> 1...2

Parameters:

<value> Range: -1e18 to 1e18
 *RST: 1.0
 Default unit: -

Manual operation: See "[2.5 V Equivalent](#)" on page 70

OUTPut:RECOOrder<output>:LIMit:UPPer:RATio:RFRatio <value>

Specifies the upper limit of the characteristic for one of the two analog outputs. Above this limit, the output is set to 2.5 V.

Suffix:

<output> 1...2

Parameters:

<value> Range: -1e18 to 1e18
*RST: 100.0
Default unit: pct

Manual operation: See "[2.5 V Equivalent](#)" on page 70

OUTPut:RECOOrder<output>:LIMit:UPPer:RATio:RLOSs <value>

Specifies the upper limit of the characteristic for one of the two analog outputs. Above this limit, the output is set to 2.5 V.

Suffix:

<output> 1...2

Parameters:

<value> Range: -180.0 to 180.0
*RST: 10.0
Default unit: dB

Manual operation: See "[2.5 V Equivalent](#)" on page 70

OUTPut:RECOOrder<output>:LIMit:UPPer:RATio:SWR <value>

Specifies the upper limit of the characteristic for one of the two analog outputs. Above this limit, the output is set to 2.5 V.

Suffix:

<output> 1...2

Parameters:

<value> Range: -1e18 to 1e18
*RST: 10.0
Default unit: -

Manual operation: See "[2.5 V Equivalent](#)" on page 70

11.12 SENSe

[SENSe<Sensor>:]AVERAge:COUNT:AUTo[:STATe].....	148
[SENSe<Sensor>:]AVERAge:COUNT[:VALue].....	148
[SENSe<Sensor>:]BWIDth:VIDeo:FNUMber.....	149
[SENSe<Sensor>:]BANDwidth:VIDeo:FNUMber.....	149
[SENSe<Sensor>:]FUNCTion[:ON].....	149

[SENSe<Sensor>:]POWer:]AVG:]APERture[:VALue].....	150
[SENSe<Sensor>:]FREQUency[:CW].....	151
[SENSe<Sensor>:]FREQUency:FIXed.....	151
SENSe<Sensor>:BURSt:MODE.....	151
SENSe<Sensor>:BURSt:PERiod.....	152
SENSe<Sensor>:BURSt:WIDTh.....	152
[SENSe<Sensor>:]DM:STANdard.....	152
[SENSe<Sensor>:]DM:STATe.....	153
[SENSe<Sensor>:]DM:WCDMa:CRATe.....	153
[SENSe<Sensor>:]DATA?.....	153
[SENSe<Sensor>:]FUNCTion:CONCurrenT.....	154
[SENSe<Sensor>:]FUNCTion:OFF:ALL<Channel>.....	154
[SENSe<Sensor>:]FUNCTion:OFF[:FUNC].....	154
[SENSe<Sensor>:]FUNCTion:STATe?.....	155
[SENSe<Sensor>:]INFormaTion?.....	155
[SENSe<Sensor>:]NAME.....	155
[SENSe<Sensor>:]POWer:CCDFunctioN:REFereNce.....	155
[SENSe<Sensor>:]POWer:REFLection:RANGe:AUTO.....	156
[SENSe<Sensor>:]POWer:REFLection:RANGe:LIMit:DETeCt.....	156
[SENSe<Sensor>:]POWer:REFLection:RANGe:LIMit[:STATe].....	157
[SENSe<Sensor>:]POWer:REFLection:RANGe:LOWer.....	157
[SENSe<Sensor>:]POWer:REFLection:RANGe[:UPPer].....	157
[SENSe<Sensor>:]POWer:PEP:HOLD.....	158
[SENSe<Sensor>:]POWer[:POWer]:RANGe:AUTO.....	158
[SENSe<Sensor>:]POWer[:POWer]:RANGe:LIMit:DETeCt.....	158
[SENSe<Sensor>:]POWer[:POWer]:RANGe:LIMit[:STATe].....	159
[SENSe<Sensor>:]POWer[:POWer]:RANGe:LOWer.....	159
[SENSe<Sensor>:]POWer[:POWer]:RANGe[:UPPer].....	160
[SENSe<Sensor>:]POWer:REFereNce.....	160
[SENSe<Sensor>:]RRESolutioN.....	160
[SENSe<Sensor>:]SWR:LIMit.....	160
[SENSe<Sensor>:]SWR:SIGNal[:TTLSignal]:LEVel.....	161

[SENSe<Sensor>:]AVERAge:COUNT:AUTO[:STATe] <state>

Enables auto averaging mode.

Parameters:

<state> *RST: ON

[SENSe<Sensor>:]AVERAge:COUNT[:VALue] <count>

Sets the filter length, i.e. the number of readings that are averaged for one measured value. The higher the count, the lower the noise, and the longer it takes to obtain a measured value.

Parameters:

<count> Range: 1 to 1048576
 *RST: 4

[SENSe<Sensor>:]BWIDth:VIDeo:FNUMber <fnum>

[SENSe<Sensor>:]BANDwidth:VIDeo:FNUMber <fnum>

Sets the video bandwidth for the rectified RF. The setting mainly influences the measurement of the peak envelope power (PEP), determination of the crest factor (CF), the measurement of the average burst power and the complementary cumulative distribution function (CCDF).

Parameters:

<numeric_value> **0**
 4 kHz

1
 200 kHz

2
 The full bandwidth depends on the power sensor:
 R&S NRT-Z14: 600 kHz
 R&S NRT-Z43, R&S NRT-Z44: 4 MHz

Range: 0 to 2
 *RST: 0

Manual operation: See "[Video Bandwidth](#)" on page 55

[SENSe<Sensor>:]FUNctIon[:ON] <function>

Sets the sensor to the selected measurement mode.

Error messages:

24	" Sensor mode not supported ": A sensor does not support a measurement mode.
28	" Sensor not idle ": The sensor is not in the IDLE state.
-151	" Invalid string data ": An invalid parameter was transmitted for <string>.

Parameters:

<function>

POWER:CFACTOR

Crest Factor

The crest factor indicates the level difference between the PEP value and the average power in dB. It allows thus to recognize larger modulation distortions.

POWER:FORWARD:AVERAGE

Average

Indicates the average power

POWer:FORWard:AVERAge:BURST**Average Burst Power**

This term is used for pulsed RF signal to define the average carrier power within the burst. The average burst is equal to the PEP (Peak Envelope Power) value if the burst is unmodulated and has no overshoots. The NRT2 measures the average burst power by multiplying the average power with the ratio of burst period to burst width. The two burst parameters must either be user-defined or the ratio is automatically determined by the NRT2. Manual entry of the parameters is possible any time and the sensors NRT-Z43/44 also allow automatic measurement.

POWer:FORWard:PEP**Peak Envelope Power**

This is the periodically recurring peak value of the carrier power at maximum modulation. The PEP is an important parameter for describing the modulation characteristics of transmitter output stages. The level difference between PEP and AVG may be between 0 dB (CW signal) and some 10 dB (radar bursts).

POWer:FORWard:CCDFunction**CCDF**

This function provides information about the probability of the peak envelope power exceeding a preset threshold. It is suitable e.g. for assessing the power distribution of spread-spectrum signals (CDMA or similar). The sensors NRT-Z43/44 provide this function. The video bandwidth can be selected.

POWer:ABSorbtion:AVERAge**Average Absorbed Power**

This function Indicates the difference between forward and reverse power.

POWer:ABSorbtion:AVERAge:BURSt**Average Absorbed Burst Power**

This function Indicates the difference between forward and reverse power (burst).

POWer:ABSorbtion:PEP**Absorbed Peak Envelope Power**

This function Indicates the difference between forward and reverse power (PEP).

POWer:REVerse**Reverse Power**

Reverse power (in W or dBm, according to power indication).

*RST: POWer:AVG

[SENSe<Sensor>:][POWer:][AVG:][APERture[:VALue] <integration_time>

Determines the integration time for a single measurement in the ContAv mode. To increase the measurement accuracy, this integration is followed by a second averaging procedure in a window with a selectable number of values. The filter window is configured with the [SENSe<[1]..4>]:AVERAge commands.

Parameters:

<integration_time> Range: 8.3e-9 to 30.0
 *RST: 0.005
 Default unit: s

[SENSe<Sensor>:]FREQUENCY[:CW] <frequency>

This command informs the NRT of the carrier frequency of the specified sensor.

The entered frequency value is required to correct the frequency-dependent response of the sensor. For this purpose NRT sensors contain a ROM with all sensor-specific data. For NAP sensors frequency-dependent calibration factors can be entered via the CALibration system.

Parameters:

<frequency> Range: 0.0 to 110.0e9
 *RST: 1.0e9
 Default unit: Hz

Example: SENS1:FREQ 10 MHz

Manual operation: See "[Freq]" on page 24
 See "<Sensor name>" on page 54

[SENSe<Sensor>:]FREQUENCY:FIXed <frequency>

This command informs the NRT of the carrier frequency of the specified sensor.

The entered frequency value is required to correct the frequency-dependent response of the sensor. For this purpose NRT sensors contain a ROM with all sensor-specific data. For NAP sensors frequency-dependent calibration factors can be entered via the CALibration system.

Parameters:

<frequency> Range: 0.0 to 110.0e9
 *RST: 1.0e9
 Default unit: Hz

Example: SENS1:FREQ 10 MHz

SENSe<Sensor>:BURSt:MODE <mode>

This command instructs the NRT how to measure the average burst power.

Parameters:

<mode> AUTO | USER

AUTO

The sensor automatically recognizes the duty cycle of the burst series and calculates the average burst power from this duty cycle and the average power. An appropriate video bandwidth has to be set. For NAP-sensors, AUTO cannot be selected.

USER

The duty cycle is defined by the burst width and burst period, see [SENSe<Sensor>:BURSt:PERiod](#) on page 152 and [SENSe<Sensor>:BURSt:WIDTh](#) on page 152. The NRT calculates the average burst power from this duty cycle and the average power.

*RST: AUTO

Example: SENS1:BURS:MODE AUTO

SENSe<Sensor>:BURSt:PERiod <value>

This command defines the burst period. It is only valid in the "USER" mode, see [SENSe<Sensor>:BURSt:MODE](#) on page 151.

Parameters:

<value> Range: 0.0 to 1.0
 *RST: 0.1
 Default unit: s

Example: SENS1:BURS:PER 1ms

SENSe<Sensor>:BURSt:WIDTh <width>

This command defines the width of a burst. It is only valid in the "USER" mode, see [SENSe<Sensor>:BURSt:MODE](#) on page 151.

Parameters:

<width> Range: 0.0 to 1.0
 *RST: 0.01
 Default unit: s

Example: SENS1:BURS:WIDT 10ms

[SENSe<Sensor>:]DM:STANdard <standard>

This command selects the communication standard. Which settings are available depends on the sensor used. The settings are valid only if the modulation correction is switched on via the `INPut<n>:DM:STATe ON` command.

Parameters:

<standard> IS95 | WCDMa | DVBT | DAB
 *RST: IS95

Example: SENS1:DM:STAN IS95

Manual operation: See "[Modulation](#)" on page 53

[SENSe<Sensor>:]DM:STATe <state>

This command switches the correction of the measurement value for modulated signals on or off. Selection of a communication standard, see [SENSe<Sensor>:]DM:STANdard on page 152, is enabled only if the correction is switched on.

Parameters:

<state> Range: "ON", "OFF"
 *RST: 0

Example: SENS1:DM:STAT ON

Manual operation: See "Modulation" on page 53

[SENSe<Sensor>:]DM:WCDMa:CRATe <value>

This command defines the chip rate for the communication standard WCDMA. The allowed range is sensor-dependent; the value is always entered without the unit (s^{-1}).

Parameters:

<value> Range: 0.0 to 8.2e6
 *RST: 1.0e6
 Default unit: Hz

Example: SENS1:DM:WCDM:CRAT 4.096E6

[SENSe<Sensor>:]DATA? [<function>]

This command provides access to the results of the current measurement(s). It is possible to request the result of a certain measurement function or to query the results of all measurement functions switched on. The measurement functions are configured with the SENS<n>:FUNC... commands.

The responses are output in the unit selected for the corresponding function. For some functions, the unit can be selected.

By defining the measurement function, the result of a special measurement function is requested. Without this specification the results of all active functions are queried. The responses are given in the sequence of the measurement functions listed under [SENS<n>:]FUNC:ON.

The command is a query and therefore has no *RST value.

Query parameters:

<function>

Example: SENS2:DATA? "POW:FORW:AVER"
 Returns the measured result for the average forward power.

Usage: Query only

[SENSe<Sensor>:]FUNCTION:CONCurent <concurrent>

This command defines whether several measurement functions may be simultaneously activated.

Parameters:

<concurrent>

ON

Two measurement functions may be simultaneously active. If two measurement functions are mutually exclusive, the error message. -221 "Settings conflict" is generated and the first setting retained. All POW:FORW and POW:ABS functions are mutually exclusive. This applies also to the POW:REV and POW:S11 functions.

OFF

Only a single function can be active. If a new measurement function is switched on, the previously active function is switched off automatically.

*RST: ON

Example:

SENS2:FUNC:CONC ON

[SENSe<Sensor>:]FUNCTION:OFF:ALL<Channel>

This command switches off all measurement functions referring to a specific channel no. <m>, i.e. SENSe<Sensor>:Function:OFF:ALL1 switches off all forward measurement functions, SENSe<Sensor>:Function:OFF:ALL2 switches off all measurement functions in the reverse channel.

The command is a function call and therefore has no *RST-value.

Suffix:

<Channel> 1...2

Example:

SENS1:FUNC:OFF:ALL1

Usage:

Event

[SENSe<Sensor>:]FUNCTION:OFF[:FUNC] <function>

This command switches off a specified measurement function. If the command is in the form of a query, the headers of all switched-off measurement functions will be returned in the sequence defined under [SENS<n>]:FUNC:ON.

The command is a function call or query and therefore has no *RST value.

Setting parameters:

<function>

Example: SENS2:FUNC:OFF "POW:REV"
 SENS2: FUNC:OFF?
 The following response would be possible:
 "POW:CFAC","POW:FORW:AVER:BURS", "POW:FORW:PEP",
 "POW:FORW:CCDF", "POW:ABS:AVER",
 "POW:ABS:AVER:BURS", "POW:ABS:PEP", "POW:REV"

Usage: Setting only

[SENSe<Sensor>:]FUNCTION:STATe? <function>

This command returns the status of the measurement function:

- Response 0: measurement function switched off
- Response 1: measurement function switched on

All functions defined under SENS<n>:FUNC:ON are available as measurement functions.

The command is a query and therefore has no *RST value.

Query parameters:

<function>

Example: SENS2:FUNC:STAT? "POW:REV"

Usage: Query only

[SENSe<Sensor>:]INFormation?

This command returns the condensed data of the sensor in form of an ASCII string.

Example: SENS2:INF?

Usage: Query only

Manual operation: See "[Sensor Info](#)" on page 71

[SENSe<Sensor>:]NAME <name>

Set a user selectable name for the sensor. This has no further influence on other functions. It exists for naming a sensor according to user requirements.

Parameters:

<name>

[SENSe<Sensor>:]POWER:CCDFunction:REference <ref>

This command defines the threshold for the cumulative distribution function (CCDF). The distribution function states the probability (in %) of the envelope power lying above the threshold. Units W or dB or dBm.

Parameters:

<ref> Range: 0.0 to 100.0e6
 *RST: 1.0e-3
 Default unit: W

Example: SENS2:POW:CCDF:REF 10W

[SENSe<Sensor>:]POWer:REFLection:RANGe:AUTO <state>

This command switches the automatic adaptation of the bargraph scaling for the reflection indication on or off.

Parameters:

<state> **ON**
 If auto-ranging is switched on, the scale limits of the bargraphs are automatically adapted to the current measured value.

OFF
 If it is switched off, the scale limits remain fixed.

*RST: 1

Example: SENS1:POW:REFL:RANG:AUTO OFF

Manual operation: See "[Autoscale](#)" on page 42
 See "[Fail Voltage](#)" on page 70

[SENSe<Sensor>:]POWer:REFLection:RANGe:LIMit:DETECT <value>

This command defines the conditions for a logic high level (> 2.7 V) being output at the AUX TTL connector if this connector has been defined as a monitoring output for the power indication (e.g. with the command `SENSe<n>:POWer:RANGe:LIMit ON`).

Parameters:

<value> INBound | OUTBound | HIGH

INBound
 A high level is output if the measured power is within the range specified by the scale limits of the lefthand bargraph.

OUTBound
 A high level is output if the measured power is out of the range defined by the scale limits of the lefthand bargraph.

HIGH
 A high level is output if the measured power exceeds the upper scale limit of the lefthand bargraph.

*RST: HIGH

Example: SENS1:POW:RANG:LIM:DET INB

Manual operation: See "[Fail Voltage](#)" on page 70

[SENSe<Sensor>:]POWer:REFLection:RANGe:LIMit[:STATe] <state>

This command can be used to define the AUX TTL connector as a monitoring output for the reflection (ON state). In the OFF state, the connector may be defined either as a monitoring output for the power indication or as a trigger input. If the AUX TTL connector is assigned more than one function, the error message –221 "Settings conflict" is generated and the first setting retained.

Parameters:

<state> Range: "ON", "OFF"
 *RST: OFF

Example:

```
TRIG:SOUR INT
SENS1:POW:RANG:LIM OFF
SENS1:POW:REFL:RANG:LIM ON
```

Manual operation: See "[Mode](#)" on page 69

[SENSe<Sensor>:]POWer:REFLection:RANGe:LOWer <lower>

This command defines the lower scale limit for the righthand bargraph (power indication).

Since the entry is made without unit, the following should be observed:

- The meaning of the entered numeric value depends on the display mode selected. The value 1.0 may mean matching (SWR indication) or total mismatch (indication of reflection coefficient).
- The entered numeric value remains the same when another display mode is selected (SWR, return loss, reflection coefficient or reverse power) so that a change of the display mode also changes the meaning of the scale limit.
- For the entered scale limit to become effective, the automatic scaling of the bargraph has to be switched off.

Parameters:

<lower> Range: -1999.0 to 1999.0
 *RST: 0.0

Example:

The following commands set the lower scale limit to an SWR of 1.0:

```
SENS1:POW:REFL:RANG:AUTO OFF
SENS1:POW:REFL:RANG:LOW 1.0
SENS1:FUNC "POW:REFL"
UNIT1:POW:REFL SWR
```

[SENSe<Sensor>:]POWer:REFLection:RANGe[:UPPer] <upper>

This command defines the upper scale limit for the righthand bargraph (reflection indication). The entry is made without unit. For further details, see [\[SENSe<Sensor>:\]POWer:REFLection:RANGe:LOWer](#) on page 157.

Parameters:

<upper> Range: -1999.0 to 1999.0
 *RST: 1.0

Example:

The following commands set the upper scale limit to a reverse power of 100 W:

```
SENS1:POW:REFL:RANG:AUTO OFF
SENS1:POW:REFL:RANG 100
SENS1:FUNC "POW:REV"
UNIT1:POW W
```

[SENSe<Sensor>:]POWer:PEP:HOLD <time>

Sets the hold time of the peak hold circuit of the sensor.

Parameters:

<time> Range: 1.0e-3 to 1.0e-1
 *RST: 6.0e-2
 Default unit: s

[SENSe<Sensor>:]POWer[:POWer]:RANGe:AUTO <state>

This command switches the automatic adaptation of the bargraph scaling to the measured power value on or off.

Parameters:

<state> **ON**
 If auto-ranging has been selected, the scale limits of the bargraphs are automatically adapted to the current measured value.

OFF
 If auto-ranging is switched off, the limits and hence the scale remain fixed.

 *RST: 1

Example:

```
SENS1:POW:RANG:AUTO OFF
```

Manual operation: See "[Autoscale](#)" on page 42

[SENSe<Sensor>:]POWer[:POWer]:RANGe:LIMit:DETECT <value>

This command defines the conditions for a logic high level (> 2.7 V) being output at the AUX TTL connector if this connector has been defined as a monitoring output for the power indication (eg with the command `SENSe<n>:POWer:RANGe:LIMit ON`).

Parameters:

<value> INBound | OUTBound | HIGH

INBound

A high level is output if the measured power is within the range specified by the scale limits of the lefthand bargraph.

OUTBound

A high level is output if the measured power is out of the range specified by the scale limits of the lefthand bargraph.

HIGH

A high level is output if the measured power exceeds the upper scale limit of the lefthand bargraph.

*RST: HIGH

Example: SENS1:POW:RANG:LIM:DET INB

[SENSe<Sensor>:]POWer[:POWer]:RANGe:LIMit[:STATe] <state>

This command can be used to define the AUX TTL connector as a monitoring output for the power indication (ON state). In OFF state, the connector may be defined either as a monitoring output for the matching or as a trigger input.

If the AUX TTL connector is assigned more than one function, the error message –221 "Settings conflict" is generated and the first setting retained.

Parameters:

<state> Range: "ON", "OFF"
*RST: OFF

Example: TRIG:SOUR INT
SENS1:POW:REFL:RANG:LIM OFF
SENS1:POW:RANG:LIM ON

Manual operation: See "[Mode](#)" on page 69

[SENSe<Sensor>:]POWer[:POWer]:RANGe:LOWer <lower>

This command defines the lower scale limit for the lefthand bargraph (power indication).

Since the entry is made without unit, the following should be observed:

- The selected unit is decisive for the absolute value of the scale limit.
- The entered numeric value remains the same when another unit is selected (W, dBm, %, dB) so that a change of the unit also causes a change of the scale limit.
- For the entered scale limit to become effective, the automatic scaling of the bargraph has to be switched off.

Parameters:

<lower> Range: -1999.0 to 1999.0
*RST: 0.0

Example: A lower scale limit of 150 mW is set with the following commands:
SENS1:POW:RANG:AUTO OFF
SENS1:POW:RANG:LOW 0.15
UNIT1:POW W

[SENSe<Sensor>:]POWer[:POWer]:RANGe[:UPPer] <upper>

This command defines the upper scale limit for the lefthand bargraph (power indication). The entry is made without unit. For details, see
SENSe<Sensor>:POWer[:POWer]:RANGe:LOWer.

Parameters:

<upper> Range: -1999.0 to 1999.0
 *RST: 1.0

Example:

An upper scale limit of 35.7 dBm is set with the following commands:

```
SENS1:POW:RANG:AUTO OFF
SENS1:POW:RANG 35.7
UNIT1:POW DBM
```

[SENSe<Sensor>:]POWer:REFerence <ref>

Enters the reference values (in W or dBm) for the relative power indication (in %, dB, or dBm). Units: Watt or dBm.

Parameters:

<ref> Range: 0.0 to 100.0e6
 *RST: 1.0
 Default unit: W

Manual operation: See "[Forward Reference Value, Reflection Reference Value](#)" on page 41

[SENSe<Sensor>:]RRESolution <rres>

This command changes the measurement resolution. This has an effect on the accuracy of the measurement, its duration, and on the number of digits indicated in the display.

Parameters:

<rres> LOW | HIGH
 *RST: LOW

Example:

```
SENS1:RRES LOW
```

Manual operation: See "[Resolution](#)" on page 47

[SENSe<Sensor>:]SWR:LIMit <limit>

This command sets the limit value for the SWR at which an alarm is triggered. For an alarm signal to be output, the forward power must also exceed a preset threshold THReshold.

Parameters:

<limit> Range: 1.0 to 100.0
 *RST: 3.0

Example: SENS1:SWR:LIM 1.5

[SENSe<Sensor>:]SWR:SIGNal[:TTLSignal]:LEVel <level>

This command is used to define the logic level of the SWR alarm at the AUX TTL connector.

Parameters:

<level> LOW | HIGH
 *RST: HIGH

Example: SENS1:SWR:SIGN:LEV HIGH

11.13 SERVICE

[SERVice:UNLock](#)..... 161

SERVice:UNLock <password>

Before other SERVice system commands are accepted, they must be enabled with SERV:UNL 1234.

Setting parameters:

<password> *RST: 0

Usage: Setting only

11.14 STATus

[STATus:OPERation:CONDition?](#)..... 162
[STATus:OPERation:ENABLE](#)..... 162
[STATus:OPERation:NTRansition](#)..... 162
[STATus:OPERation:PTRansition](#)..... 162
[STATus:OPERation\[:EVENT\]?](#)..... 162
[STATus:OPERation:BIT<bitno>:CONDition?](#)..... 162
[STATus:OPERation:BIT<bitno>:ENABLE](#)..... 162
[STATus:OPERation:BIT<bitno>:NTRansition](#)..... 163
[STATus:OPERation:BIT<bitno>:PTRansition](#)..... 163
[STATus:OPERation:BIT<bitno>\[:EVENT\]?](#)..... 163
[STATus:PRESet](#)..... 163
[STATus:QUEStionable:CONDition?](#)..... 163
[STATus:QUEStionable:ENABLE](#)..... 163
[STATus:QUEStionable:NTRansition](#)..... 164
[STATus:QUEStionable:PTRansition](#)..... 164
[STATus:QUEStionable\[:EVENT\]?](#)..... 164
[STATus:QUEStionable:BIT<bitno>:CONDition?](#)..... 164
[STATus:QUEStionable:BIT<bitno>:ENABLE](#)..... 164

STATus:QUEStionable:BIT<bitno>:NTRansition.....	164
STATus:QUEStionable:BIT<bitno>:PTRansition.....	164
STATus:QUEStionable:BIT<bitno>[:EVENT]?.....	165
STATus:QUEue[:NEXT]?.....	165

STATus:OPERation:CONDition?

Return values:

<RegisterValue>

Usage: Query only

STATus:OPERation:ENABLE <RegisterValue>

Parameters:

<RegisterValue>

STATus:OPERation:NTRansition <RegisterValue>

Parameters:

<RegisterValue>

STATus:OPERation:PTRansition <RegisterValue>

Parameters:

<RegisterValue>

STATus:OPERation[:EVENT]?

Return values:

<RegisterValue>

Usage: Query only

STATus:OPERation:BIT<bitno>:CONDition?

Suffix:

<bitno> 8..12

Return values:

<RegisterBit>

Usage: Query only

STATus:OPERation:BIT<bitno>:ENABLE <RegisterBit>

Suffix:

<bitno> 8..12

Parameters:

<RegisterBit>

STATus:OPERation:BIT<bitno>:NTRansition <RegisterBit>**Suffix:**

<bitno> 8..12

Parameters:

<RegisterBit>

STATus:OPERation:BIT<bitno>:PTRansition <RegisterBit>**Suffix:**

<bitno> 8..12

Parameters:

<RegisterBit>

STATus:OPERation:BIT<bitno>[:EVENT]?**Suffix:**

<bitno> 8..12

Return values:

<RegisterBit>

Usage: Query only

STATus:PRESetResets the edge detectors and `ENABLe` parts of all registers to a defined value.**Usage:** Event

STATus:QUEStionable:CONDition?**Return values:**

<RegisterValue>

Usage: Query only

STATus:QUEStionable:ENABle <RegisterValue>**Parameters:**

<RegisterValue>

STATus:QUESTIONable:NTRansition <RegisterValue>

Parameters:

<RegisterValue>

STATus:QUESTIONable:PTRansition <RegisterValue>

Parameters:

<RegisterValue>

STATus:QUESTIONable[:EVENT]?

Return values:

<RegisterValue>

Usage: Query only

STATus:QUESTIONable:BIT<bitno>:CONDition?

Suffix:

<bitno> 9..12

Return values:

<RegisterBit>

Usage: Query only

STATus:QUESTIONable:BIT<bitno>:ENABLE <RegisterBit>

Suffix:

<bitno> 9..12

Parameters:

<RegisterBit>

STATus:QUESTIONable:BIT<bitno>:NTRansition <RegisterBit>

Suffix:

<bitno> 9..12

Parameters:

<RegisterBit>

STATus:QUESTIONable:BIT<bitno>:PTRansition <RegisterBit>

Suffix:

<bitno> 9..12

Parameters:

<RegisterBit>

STATus:QUESTIONable:BIT<bitno>[:EVENT]?**Suffix:**

<bitno> 9..12

Return values:

<RegisterBit>

Usage:

Query only

STATus:QUEue[:NEXT]?

Queries the most recent error queue entry and deletes it.

Positive error numbers indicate sensor specific errors, negative error numbers are error messages defined by SCPI. If the error queue is empty, the error number 0, "No error", is returned.

Return values:

<ErrorCode>

<ErrorDescription>

Usage:

Query only

11.15 SYSTem

SYSTem:COMMunicate:GPIB[:SELF]:ADDRess.....	167
SYSTem:COMMunicate:INET[:SELF]:MODE.....	167
SYSTem:COMMunicate:NETWork[:IPADdress]:MODE.....	167
SYSTem:COMMunicate:INET[:SELF]:ADDRess.....	167
SYSTem:COMMunicate:NETWork[:IPADdress]:ADDRess.....	167
SYSTem:COMMunicate:INET[:SELF]:GATeway:ADDRess.....	168
SYSTem:COMMunicate:NETWork[:IPADdress]:GATeway.....	168
SYSTem:COMMunicate:INET[:SELF]:SUBNetmask:ADDRess.....	168
SYSTem:COMMunicate:NETWork[:IPADdress]:SUBNet:MASK.....	168
SYSTem:COMMunicate:INET[:SELF]:DNS:ADDRess.....	168
SYSTem:COMMunicate:NETWork[:IPADdress]:DNS.....	168
SYSTem:COMMunicate:INET[:SELF]:DNS:SUFFix.....	169
SYSTem:COMMunicate:NETWork[:COMMOn]:DOMain.....	169
SYSTem:COMMunicate:NETWork[:COMMOn]:HOSTname.....	169
SYSTem:COMMunicate:NETWork[:COMMOn]:WORKgroup.....	169
SYSTem:COMMunicate:NETWork:REStart.....	170
SYSTem:COMMunicate:NETWork:STATus?.....	170
SYSTem:COMMunicate:NETWork:MACaddress?.....	170
SYSTem:DATE.....	170
SYSTem:DEVIce:ID?.....	170
SYSTem:DFPPrint.....	171
SYSTem:DFPPrint:HISTory:COUNT?.....	171
SYSTem:DFPPrint:HISTory:ENTRy?.....	171

SYSTem:DID?	171
SYSTem:DISPlay:UPDate	171
SYSTem:INFO[:INFO]?	172
SYSTem:IDN:MODE	172
SYSTem:IDN:ANSWer	172
SYSTem:IDN:AUTO	173
SYSTem:OPT:MODE	173
SYSTem:OPT:ANSWer	173
SYSTem:OPT:AUTO	174
SYSTem:SPEed	174
SYSTem:PRESet	174
SYSTem:REBoot	174
SYSTem:ERRor:ALL?	174
SYSTem:ERRor:CODE:ALL?	174
SYSTem:ERRor:CODE[:NEXT]?	175
SYSTem:ERRor:COUNT?	175
SYSTem:ERRor[:NEXT]?	175
SYSTem:HCOPy	175
SYSTem:INFO:TERMchar	176
SYSTem:VERSion?	176
SYSTem:FWUPdate	176
SYSTem:FWUPdate:STATus?	177
SYSTem:HELP:HEADers?	177
SYSTem:HELP:SYNTax?	178
SYSTem:HELP:SYNTax:ALL?	178
SYSTem:KLOCK	178
SYSTem:LOCK:NAME?	178
SYSTem:LOCK:NAME:DETAiled?	178
SYSTem:LOCK:OWNer?	178
SYSTem:LOCK:OWNer:DETAiled?	179
SYSTem:LOCK:RELease	179
SYSTem:LOCK:RELease:ALL	179
SYSTem:LOCK:REQuest:SHARed?	179
SYSTem:LOCK:REQuest[:EXCLusive]?	179
SYSTem:LOCK:SHARed:STRing?	180
SYSTem:LOCK:TImeout	180
SYSTem:SERRor?	180
SYSTem:SERRor[:ALL]?	180
SYSTem:SERRor:REMove	180
SYSTem:SERRor:LIST:ALL?	181
SYSTem:SHUTdown	181
SYSTem:TIME:DSTime:MODE	181
SYSTem:TIME:DSTime:RULE	181
SYSTem:TIME:DSTime:RULE:CATalog?	181
SYSTem:TIME:HRTimer:ABSolute	181
SYSTem:TIME:HRTimer:ABSolute:SET	182
SYSTem:TIME:HRTimer:RELative	182
SYSTem:TZONE	182
SYSTem:VERSion?	182

SYSTem:COMMunicate:GPIB[:SELF]:ADDRess <address>

Sets the address with which the R&S NRT2 can be addressed via the IEC/IEEE bus. The address is factory-set to 12 and is not changed by a reset.

Parameters:

<address> int_value
 Range: 1 to 30
 *RST: 12

Manual operation: See "[GPIB Address](#)" on page 67

SYSTem:COMMunicate:INET[:SELF]:MODE <state>**SYSTem:COMMunicate:NETWork[:IPADdress]:MODE** <mode>

Selects if the IP address is assigned automatically or manually.

Parameters:

<mode> AUTO | STATic
AUTO
 Assigns the IP address automatically, provided the network supports DHCP.
STATic
 Enables assigning the IP address manually.
 *RST: AUTO

Example: :SYST:COMM:NETW:IPAD:MODE AUTO
 The IP address is assigned automatically.

Manual operation: See "[Address Mode](#)" on page 64

SYSTem:COMMunicate:INET[:SELF]:ADDRess <IPaddress>**SYSTem:COMMunicate:NETWork[:IPADdress][:ADDRess]** <IPaddress>

Sets the IP address of the R&S NRT2 if the address mode is set to *STATic*.

Note: Choosing an invalid IP-Address may disturb the traffic on your LAN. If you are not sure how to configure these settings, please ask your network administrator.

Parameters:

<IPaddress> The four parameter form the IP address x.y.z.a.
 Range: 0...255 for each part of the IP address
 *RST: This setting is not changed by *RST.

Example: SYSTem:COMMunicate:NETWork:IPADdress:ADDRess
 108.0.0.255
 Sets the IP address to 104.0.0.255

Manual operation: See "[IPv4 Address](#)" on page 65

SYSTem:COMMunicate:INET[:SELF]:GATeway:ADDResS <Gateway>

SYSTem:COMMunicate:NETWork[:IPADdress]:GATeway <Gateway>

Sets the IP address of the default gateway, if the address mode is set to *STATIC*.

Note: Choosing an invalid IP-Address may disturb the traffic on your LAN. If you are not sure how to configure these settings, please ask your network administrator.

Parameters:

<Gateway> The four parameter form the IP address x.y.z.a.
 Range: 0 to 255
 *RST: This setting is not changed by *RST.

Example: SYSTem:COMMunicate:NETWork:IPADdress:GATeway
 '192.168.10.254'
 Sets the IP address of the default gateway to
 192.168.10.254.

Manual operation: See "[Default Gateway](#)" on page 65

SYSTem:COMMunicate:INET[:SELF]:SUBNetmask:ADDResS <Mask>

SYSTem:COMMunicate:NETWork[:IPADdress]:SUBNet:MASK <Mask>

Sets the subnet mask, if the address mode is set to *STATIC*.

Note: Choosing an invalid IP-Address may disturb the traffic on your LAN. If you are not sure how to configure these settings, please ask your network administrator.

Parameters:

<Mask> The four parameter form the IP address x.y.z.a.
 Range: 0 to 255
 *RST: This setting is not changed by *RST.

Example: SYSTem:COMMunicate:NETWork:IPADdress:SUBNet:
 MASK '255.255.255.0'
 Sets the subnet mask IP address to 255.255.255.0.

Manual operation: See "[Subnet Mask](#)" on page 65

SYSTem:COMMunicate:INET[:SELF]:DNS:ADDResS <server>

SYSTem:COMMunicate:NETWork[:IPADdress]:DNS <server>

Sets the IP address of the network DNS server if the address mode is set to *STATIC*.

Parameters:

<server> The four parameter form the IP address x.y.z.a.
 Range: 0 to 255
 *RST: This setting is not changed by *RST.

Example: SYST:COMM:NETW:IPAD:DNS 123.456.0.1
 Sets the IP address of the DNS server to 123.456.0.1.

Manual operation: See "[DNS Server](#)" on page 65

SYSTem:COMMunicate:INET[:SELF]:DNS:SUFFix <Domain>

Stores a DNS suffix which can be used in name resolution queries.

Parameters:

<suffix>

Manual operation: See ["DNS Suffix"](#) on page 64

SYSTem:COMMunicate:NETWork[:COMMON]:DOMain <domain>

Sets the domain of the network.

Parameters:

<domain>

Example: :SYSTem:COMMunicate:NETWork:COMMON:DOMain
 ABC.DE

Sets the domain of the network to ABC.DE.

Manual operation: See ["DNS Suffix"](#) on page 64

SYSTem:COMMunicate:NETWork[:COMMON]:HOSTname <hostname>

Sets the individual host name of the power sensor.

In a LAN that uses a DNS server (Domain Name System server), each instrument connected in the LAN can be accessed via an unambiguous host name, instead of the IP address. The DNS server translates the host name to the IP address. This is especially useful when a DHCP server is used, as a new IP address may be assigned each time the instrument is restarted.

The sensor performs the change of the hostname immediately after the command is sent. For this purpose the sensor restarts its connection to the network. During this time that may take several seconds the sensor cannot be addressed. After the restart the sensor can be addressed only through the newly set hostname.

Note: It is recommended that you do not change the default host name in order to avoid problems with the network connection. However, if you change the host name be sure to use a unique name.

Parameters:

<hostname>

Example: SYSTem:COMMunicate:NETWork:COMMON:HOST
 'powersensor-2nd-floor'

Sets the hostname to powersensor-2nd-floor.

Manual operation: See ["Host Name"](#) on page 63

SYSTem:COMMunicate:NETWork[:COMMON]:WORKgroup <Workgroup>

Sets an individual workgroup name for the instrument.

Parameters:

<Workgroup>

SYSTem:COMMunicate:NETWork:REStart

Restarts the network connection to the instrument, i.e. terminates the connection and sets it up again.

Usage: Event

SYSTem:COMMunicate:NETWork:STATus?

Queries the network configuration state.

Example: SYSTem:COMMunicate:NETWork:STATus?
Response: UP
The network is active.**Usage:** Query only

SYSTem:COMMunicate:NETWork:MACaddress?

Queries the MAC address of the network adapter.

Parameters:

<MacAddress> string

Usage: Query only

SYSTem:DATE <year>, <month>, <day>

Queries or sets the date for the instrument-internal calendar.

This parameter is protected, in order to prevent accidental changes.

Parameters:

<year> <year>,<month>,<day>

<month> Range: 1 to 12

<day> Range: 1 to 31

Manual operation: See ["Date"](#) on page 75

SYSTem:DEvice:ID?

Queries the Rohde & Schwarz device ID.

Return values:

<DeviceID>

Usage: Query only**Manual operation:** See ["System Info"](#) on page 74

SYSTem:DFPRint [<Path>]

Generate device footprint.

Setting parameters:

<Path>

Return values:

<XMLDeviceFootprint><dblock>

SYSTem:DFPRint:HISTory:COUNT?

Request the number of device footprints in history.

Return values:

<Count>

Usage: Query only

SYSTem:DFPRint:HISTory:ENTRY? <index>

Return a device footprint from the history. Index "0" returns the most recent one.

Query parameters:

<index>

Return values:

<XmlDeviceFootprint><dblock>

Usage: Query only

SYSTem:DID?

Get R&S device ID.

Return values:

<DeviceID>

Usage: Query only

Manual operation: See "[System Info](#)" on page 74

SYSTem:DISPlay:UPDate <displayupdate>

Switches the update of the display on/off. A switchover from remote control to manual control always sets the status of the update of the display to ON.

Parameters:

<displayupdate> 0 | 1 | OFF | ON
*RST: ON

Example: SYST:DISP:UPD OFF
switches update of displayed parameter values off.

SYSTem:INFO[:INFO]? [<argument>]

Returns information about the system.

If queried without parameters, the command returns all available information in the form of a list of strings separated by commas.

If you want to query specific information, add the query parameter:

```
SYST:INFO? "<string>"
```

Query parameters:

<argument> 'Manufacturer', 'Type', 'Stock Number', 'Serial', 'SW Build', 'MAC Address', 'Hostname', 'IP Address', 'Domain', 'Subnetmask', 'Gateway', 'Mode', 'Status', 'Sensor Name', 'Technology', 'Function', 'MinPower', 'MaxPower', 'MinFreq', 'MaxFreq', 'Impedance', 'Coupling', 'Uptime', 'Cal. Misc.', 'Cal. Abs.', 'Cal. Refl.', 'Cal. Temp.', 'Cal. Lin.', 'Cal. S-Para.', 'Cal. S-Para. (User)', 'SPD Mnemonic', 'Cal. Due Date', 'Certificate No', 'Limit', 'TestLimit', 'TestLimit pd'

Usage: Query only

Manual operation: See "[System Info](#)" on page 74

SYSTem:IDN:MODE <mode>

Selects if the automatically created instrument identification string is used or a user-defined option string can be created and used.

Parameters:

<mode> AUTO | USER

AUTO

The automatically instrument identification string is used.

USER

The user-defined instrument identification string is used. The user-defined instrument identification string is defined with command [SYSTem:IDN:ANSWer](#) on page 172.

*RST: AUTO

Manual operation: See "[Customization of *IDN?](#)" on page 67

SYSTem:IDN:ANSWer <string>

Defines the return value for the *IDN query. The maximum string length is 128 characters.

Parameters:

<string> The string entered is returned with query *IDN?.

Example:

```

SYST:IDN:MODE USER
Selects user-defined identification
SYST:IDN:ANSW "Test Device"
Defines the identification string 'Test Device'
*IDN?
Response: 'Test Device'
```

Manual operation: See ["Custom IDN String"](#) on page 68

SYSTem:IDN:AUTO <state>

Activates/deactivates the return of a user-defined string for the *IDN query.

Parameters:

```

<status>          ON | OFF
*RST:             1
```

Manual operation: See ["Customization of *IDN?"](#) on page 67

SYSTem:OPT:MODE <mode>

Selects if the automatically created option identification string is used or a user-defined option string can be created and used.

Parameters:

```

<mode>           AUTO | USER

AUTO
The automatically option identification string is used.

USER
The user-defined option string is used. The user-defined option
string is defined with command SYSTem:OPT:ANSWer
on page 173.

*RST:            AUTO
```

Manual operation: See ["Customization of *OPT?"](#) on page 67

SYSTem:OPT:ANSWer <string>

Defines the return value for the *OPT query. The maximum string length is 128 characters.

Parameters:

```

<string>         The string entered is returned with query *OPT?.
```

Example:

```

SYST:OPT:MODE USER
Selects user-defined identification
SYST:OPT:ANSW "Test Option"
Defines the option string 'Test Option'
*OPT?
Response: 'Test Option'
```

Manual operation: See ["Custom OPT String"](#) on page 68

SYSTem:OPT:AUTO <state>

Activates/deactivates the return of a user-defined string for the *OPT query.

Parameters:

<status> ON | OFF
 *RST: 1

Manual operation: See ["Customization of *OPT?"](#) on page 67

SYSTem:SPEed <mode>

The data processing speed of the R&S NRT2 can be increased when `FAST` is selected. The display is switched off and the measured values are no longer displayed since the continuous update of the screen content requires computation time.

Parameters:

<mode> NORMal | FAST
 *RST: NORMal

SYSTem:PRESet

Triggers a sensor reset.

Usage: Event

SYSTem:REBoot

Reboots the power sensor.

Usage: Event

SYSTem:ERRor:ALL?

Queries all unread entries in the error/event queue and removes them from the queue. The response is a comma-separated list of error numbers and a short description of the error in the first in first out order.

Positive error numbers are instrument-dependent. Negative error numbers are reserved by the SCPI standard.

Usage: Query only

SYSTem:ERRor:CODE:ALL?

Queries all unread entries in the error/event queue and removes them from the queue. Only the error numbers are returned and not the entire error text.

Example: SYSTem:ERRor:CODE:ALL?
 Queries all entries in the error queue.
 Response: 0
 No errors have occurred since the error queue was last read out.

Usage: Query only

SYSTem:ERRor:CODE[:NEXT]?

Queries the oldest entry in the error queue and then deletes it. Only the error number is returned and not the entire error text.

Example: SYSTem:ERRor:CODE
 Queries the oldest entry in the error queue.
 Response: 0
 No errors have occurred since the error queue was last read out.

Usage: Query only

SYSTem:ERRor:COUnT?

Queries the number of entries in the error queue.

Example: SYSTem:ERRor:COUnT
 Queries the number of entries in the error queue.
 Response: 1
 One error has occurred since the error queue was last read out.

Usage: Query only

SYSTem:ERRor[:NEXT]?

Queries the error/event queue for the oldest item and removes it from the queue. The response consists of an error number and a short description of the error.

Positive error numbers are instrument-dependent. Negative error numbers are reserved by the SCPI standard.

Example: SYSTem:ERRor?
 Queries the oldest entry in the error queue.
 Response: 0, 'no error'
 No errors have occurred since the error queue was last read out.

Usage: Query only

SYSTem:HCOPy [<filename>]

Triggers a screenshot (hardcopy) of the current display. If a filename is given, this is used as a target file. Otherwise an internal name is generated which can be read by the query function.

Parameters:
 <filename>

Manual operation: See "Screenshot" on page 23

SYSTem:INFO:TERMchar <termination>

Selects the termination character(s) for returned information.

Parameters:

<termination> CR | LF | CRLF | STRS
 *RST: STRS

SYSTem:VERSion?

Queries the SCPI version the sensor's command set complies with.

Example: SYSTem:VERSion?
 Queries the SCPI version.
 Response: 1999.0
 The sensor complies with the SCPI version from 1999.

Usage: Query only

SYSTem:FWUPdate <fwudata>

This command is used to load new operating firmware into the device.

Rohde & Schwarz provides new firmware in form of *.rsu files. An *.rsu file often can be downloaded from the Rohde & Schwarz web sites or can be supplied by the customer support or the product marketing. The *.rsu file is usually packed in a *zip archive that must be extracted before.

If you want to integrate a firmware update function in their own application, use the SYSTem:FWUPdate command. The parameter of this command is a "Definite Length Arbitrary Block Data" containing the direct copy of the binary *.rsu file.

A "Definite Length Datablock" has a well-defined format. It consists of:

- A '#' sign.
- A single digit indicating the length of the number which represents the size of the binary file.
- The binary data.
- An appended delimiter (LF, 0x0a).

Example:

Lets assume that this file has a size of 10242884 bytes.

To send the file to the sensor for updating the firmware, your application has to assemble a memory block containing:

- The command.
- The "Definite Length Block" header.
- The contents of the *.rsu file.
- A trailing delimiter (0x0a = Linefeed).

First, have a look at the size of the binary data; it is 10242884 in this case. This number has 8 digits. Now you have all the information to assemble everything:

- The `SYST:FWUP` command
- A blank as a separator
- The '#' sign
- The '8' for the length of the file size
- The '10242884' specifying the size of the file
- (the contents of the *.rsu file).....
- 0x0a as a delimiter

In this example, you would write exactly 10242905 bytes to the sensor (for example via a 'viWrite()' function).

The result sums up from the values of the above list to:

$$9 + 1 + 1 + 1 + 1 + 8 + 10242884 + 1 = 10242905$$

In a (pseudo) string notation, it is:

```
SYST:FWUP #810242884.....(file content)..... <LF> ,
```

Where <LF> is a single 0x0a character and(file content)..... is the direct byte-by-byte contents of the *.rsu file.

Setting parameters:

<fwudata> <block_data>

Usage: Setting only

SYSTem:FWUPdate:STATus?

While a firmware update is in progress, the LED of the sensors flashes in bright white color. As soon as the firmware update is over you can read the result of the update with the `SYST:FWUP:STAT?` command.

The result of the query is a readable string.

Example: `SYSTem:FWUPdate:STATus?`
 Response: "Success"

Usage: Query only

SYSTem:HELP:HEADers? [<Parser>]

Query parameters:

<Parser>

Return values:

<Headers> <dblock>

Usage: Query only

SYSTem:HELP:SYNTax? <Header>**Query parameters:**

<Header>

Return values:

<Syntax> <dblock>

Usage: Query only

SYSTem:HELP:SYNTax:ALL?

Queries the implemented SCPI commands and their parameters. Returns the result as a block data.

Return values:

<Syntax> <dblock>

Usage: Query only

SYSTem:KLOCK <klock>**Parameters:**

<klock>

SYSTem:LOCK:NAME?

Returns the name of the interface over which the query was made.

Return values:

<name>

Usage: Query only

SYSTem:LOCK:NAME:DETAiled?

Returns the detailed name of the interface over which the query was made.

Return values:

<name>

Usage: Query only

SYSTem:LOCK:OWNer?

Returns the current owner(s) of the locking. In case of shared locking, each interface is listed only once. If there is additionally an exclusive lock, only the owner of this exclusive lock is returned.

Return values:

<owner>

Usage: Query only

SYSTem:LOCK:OWNer:DETAiled?

Returns the current owner(s) of the locking, including all locking details. In case of shared locking, each interface is listed only once. If there is additionally an exclusive lock, only the owner of the exclusive lock is returned.

Return values:

<owner>

Usage: Query only

SYSTem:LOCK:RELease

Releases a locking if the calling client is the owner of the locking. If no locking is active or the calling client is not the owner of the locking, nothing happens.

In case of an active shared locking, the device is locked until all members of the shared locking group have released the locking.

Usage: Event

SYSTem:LOCK:RELease:ALL

Releases all locking of the calling client.

Usage: Event

SYSTem:LOCK:REQuest:SHARed? <lock_string>[, <timeout>]

This query tries to initiate a shared locking. A lock string must be specified. If successful, the actual lock string of this locking group is returned, otherwise 0.

Query parameters:

<lock_string>

<timeout>

Return values:

<result>

Usage: Query only

SYSTem:LOCK:REQuest[:EXCLusive]? [<timeout>]

This query attempts to initiate an exclusive locking. If successful, 1 is returned, otherwise 0.

Optionally, a timeout in milliseconds can be specified, specifying the maximum time to wait for the device to become free if a locking is already active.

The owner of an exclusive locking can call `SYST:LOCK:REQ?` even if an exclusive lock already exists. However, `SYST:LOCK:REL` must be called just as often until the device is released again.

Query parameters:

<timeout>

Return values:

<result>

Usage: Query only

SYSTem:LOCK:SHARed:STRing?

Returns the lock string assigned to the locking group when shared locking is active. If no shared locking was previously initiated, an error is written to the error queue.

Return values:

<result>

Usage: Query only

SYSTem:LOCK:TIMEout <timeout>

Sets the maximum time in milliseconds to wait when processing a command if the device is locked and the sender of the command is not the owner of the lock before the command is discarded and an error is written to the error queue.

Setting parameters:

<timeout>

Return values:

<result>

SYSTem:SERRor?

Returns the next static error (if any). Static errors are generally more severe than normal error conditions, which can be queried with `SYSTem:ERRor[:NEXT]?`. While normal errors result from, for example, unknown commands or syntax errors and generally affect a single parameter or setting, the static errors, as a rule, prevent the execution of normal measurements.

Usage: Query only

SYSTem:SERRor[:ALL]?

Queries the (next) error from the list of static errors.

Usage: Query only

SYSTem:SERRor:REMOve <num>

Removes an entry from the list of static errors. The entry is identified by a unique sequence number <num>.

Setting parameters:

<num> *RST: 0

Usage: Setting only

SYSTem:SERRor:LIST:ALL?

Queries the list of all static errors that have occurred so far. The list is persistent. Entries can be removed by `SYSTem:SERRor:REMove <n>`.

Usage: Query only

SYSTem:SHUTdown

Shuts down the instrument.

Usage: Event

SYSTem:TIME:DSTime:MODE <dst>**Parameters:**

<dst>

SYSTem:TIME:DSTime:RULE <rule>

Sets the timezone. You can query the list of the available timezones with `SYSTem:TIME:DSTime:RULE:CATalog?` on page 181.

Parameters:

<rule>

Manual operation: See "Time Zone Region" on page 75
See "Time Zone" on page 75

SYSTem:TIME:DSTime:RULE:CATalog?

Queries the list of available time zones.

Return values:

<cat>

Usage: Query only

Manual operation: See "Time Zone Region" on page 75
See "Time Zone" on page 75

SYSTem:TIME:HRTimer:ABSolute <duration>

Start a timer relative to an absolutely set start time.

Setting parameters:

<duration>

Usage:

Setting only

Asynchronous command

SYSTem:TIME:HRTimer:ABSolute:SET

Define the start time for an absolute timer.

Return values:

<year>

<month>

<day>

<hour>

<min>

<sec>

<msec>

SYSTem:TIME:HRTimer:RELative <duration>

Start a timer expiring after a given duration from the command's execution time.

Setting parameters:

<duration>

Usage:

Setting only

Asynchronous command

SYSTem:TZONE <hour>, <minute>

Specifies the offset of the local time to the UTC time, due to the time zone. There can be an additional offset due to daylight saving time (DST).

Changing the time zone (offset) does not affect an eventual DST offset and the time zone configured via [SYSTem:TIME:DSTime:RULE](#) on page 181.The local time is calculated as: *local time = UTC + time zone offset + DST offset*.**Parameters:**

<hour> Range: -12 to 15

<minute> Range: -59 to 59

SYSTem:VERSion?**Return values:**

<version>

Usage: Query only

11.16 TEST

TEST:SENSor<Sensor>?	183
TEST:ALL?	183
TEST:DIRect	183
TEST:FRAM?	184
TEST:RAM?	184
TEST:ROM?	184

TEST:SENSor<Sensor>?

This command returns the status of the active sensor.

Example: TEST:SENS ?
 The response is sensor-dependent and could read as follows:
 "NRT-Z44 V1.40", "TEMPERATURE ERR", "CAL VALUES CHECKSUM ERR"

The response always contains an identification string for the sensor with the type name and the FW version number. In case of an error, error messages in plain text are appended. The content of the response string is identical with the status query in manual control.

Usage: Query only

Manual operation: See "[Sensor Test](#)" on page 72

TEST:ALL?

The command tests all memories of the instrument. This command is a query and therefore has no *RST value.

Parameters:
 <sensor_command> *RST: -

Example: TEST?

Usage: Query only

TEST:DIRect <sensor_command>

This command is used for transferring direct setting commands to the active sensor. The setting commands are contained in the sensor manual. With a ? appended, the command returns the response of the sensor to the transferred command.

This command has no *RST value.

Parameters:
 <sensor_command> *RST: -

Example: TEST:DIR "sensor command"

TEST:FRAM?

The command tests the parameter memory. This command is a query and therefore has no *RST value.

Parameters:

<sensor_command> *RST: -

Example: TEST:FRAM?

Usage: Query only

TEST:RAM?

The command tests the RAM. This command is a query and therefore has no *RST value.

Parameters:

<sensor_command> *RST: -

Example: TEST:RAM?

Usage: Query only

TEST:ROM?

The command tests the program ROM. This command is a query and therefore has no *RST value.

Parameters:

<sensor_command> *RST: -

Example: TEST:ROM?

Usage: Query only

11.17 TRIGGER

TRIGger<Measurement>[:IMMediate].....	184
TRIGger<Measurement>:MODE.....	185
TRIGger<Measurement>:SOURce.....	185

TRIGger<Measurement>[:IMMediate]

This command triggers a measurement.

Suffix:

<Measurement> 1...100

Usage: Event

TRIGger<Measurement>:MODE <mode>

The trigger mode determines the behavior of the instrument if no trigger occurs, and also the number of acquired waveforms when a trigger occurs.

Suffix:

<Measurement> 1...100

Parameters:

<mode> NORMal | FREerun | SINGle

NORMal

Continuous triggering with regular trigger events.

FREerun

This setting automatically starts a measurement if no trigger event has occurred after 300 ms.

SINGle

This setting disables continuous triggering so that only one trigger event at a time is executed.

*RST: NORMal

Manual operation: See "[Trigger Mode](#)" on page 46

TRIGger<Measurement>:SOURce <mode>

This command sets the trigger source for all the following measurements.

Suffix:

<Measurement> 1...100

Parameters:

<mode> INTernal | EXTernal

INTernal

The internal timer is used as a trigger source. As a result, the measurement is performed in the freerun mode. This implies that the sensor carries out measurements permanently but that they are not related to the test signal.

EXTernal

This mode allows to trigger measurements via the two remote control interfaces (commands :TRIG and *TRG) or the AUX TTL connector at the rear panel of the device. The event which arrives first is used for triggering. The measurement is triggered immediately after the trigger event arrives. The measured quantity may change before triggering starts but should then remain unchanged until the end of the measurement.

*RST: INTernal

Manual operation: See "[Trigger Source](#)" on page 46

11.18 UNIT

UNIT<Measurement>:POWer:RATio.....	186
UNIT<Measurement>:POWer[:VALue].....	186
UNIT<Measurement>:POWer:REFlection.....	187
UNIT<Measurement>:POWer:RELative:STATE.....	187
UNIT<Measurement>:POWer:RELative[:VALue].....	188

UNIT<Measurement>:POWer:RATio <unit>

Selects the output unit for the measured power ratio values.

This setting also determines the unit for the parameters of the following commands:

- CALC:REL
- CALC:LIM:UPP
- CALC:LIM:LOW
- DISP:MET:UPP
- DISP:MET:LOW
- OUTP:REC:LIM:LOW
- OUTP:REC:LIM:UPP

Error messages:

If the compute function of the associated calculate block is :SWR, :RLOSS or :REFlection, then the unit cannot be changed and error message **26,"State not supported"**, is output.

Suffix:

<Measurement> 1...100

Parameters:

<unit> DB | DPCT | O
*RST: DB

Manual operation: See "[Fwd Unit](#)" on page 40

UNIT<Measurement>:POWer[:VALue] <unit>

Selects the output unit for the measured power values.

This setting also determines the unit for the parameters of the following commands:

- CALC:REL
- CALC:LIM:UPP
- CALC:LIM:LOW
- DISP:MET:UPP
- DISP:MET:LOW
- OUTP:REC:LIM:LOW
- OUTP:REC:LIM:UPP

Suffix:

<Measurement> 1...100

Parameters:

<unit> DBM | DBUV | W
 *RST: DBM

Manual operation: See ["Fwd Unit"](#) on page 40**UNIT<Measurement>:POWer:REFlection <unit>**

This command defines the matching of the load being measured as standing wave ratio, return loss, reflection coefficient, or power ratio R/F (in percent).

NOTE: The command is only effective if the measurement function POW:S11 or POW:REFL has been activated, see SENS<n>:FUNC subsystem

Suffix:

<Measurement> 1...100

Parameters:

<unit> RCO | RL | SWR | RFR

RCO

Reflection coefficient (0 to 1, without unit)

RL

Return loss (in dB)

SWR

Standing wave ratio (1 to ∞, without unit)

RFR

Ratio between forward and reverse power (0% to 100%)

*RST: SWR

Example:

```
SENSe1:FUNC "POW:REFL"
UNIT1:POW:REFL RCO
```

Manual operation: See ["Standing Wave Ratio \(SWR\)"](#) on page 40
 See ["Return Loss"](#) on page 40
 See ["Reflection Coefficient"](#) on page 40
 See ["Reflection Ratio"](#) on page 40

UNIT<Measurement>:POWer:RELative:STATe <state>

This command defines the indication of the forward power (FWD), reverse power (REV) and absorbed power (F-R) in absolute units (W, dBm) or in relative display mode (% , dB).

Suffix:

<Measurement> 1...100

Parameters:

<state>

ON

Switches the relative display mode on and the absolute display off.

OFF

OFF has the opposite effect.

*RST: 0

Example:

UNIT1:POW:REL:STAT ON

UNIT<Measurement>:POWER:RELative[:VALue] <unit>

This command allows the forward power (FWD) and the absorbed power (F-R) to be indicated in relative display mode. For the setting to become effective, the relative display mode must be switched on, see [UNIT<Measurement>:POWER:RELative:STATe](#) on page 187 and the `UNIT<n>:POWER:RELative:STATe ON` command.

Suffix:

<Measurement> 1...100

Parameters:

<unit> PCT | DB

PCT

Deviation from reference value in percent.

DB

Deviation from reference value in dB.

*RST: PCT

Example:

UNIT2:POW:REL:STAT ON

UNIT2:POW:REL DB

12 Troubleshooting

- [Displaying Information](#)..... 189
- [Notifications](#)..... 189
- [Performing Tests](#)..... 191
- [Collecting Information for Technical Support](#)..... 192
- [Contacting Customer Support](#)..... 192

12.1 Displaying Information

Status information

Status information is displayed in the title bar of the graphical user interface. See [Chapter 4, "Operating Concepts"](#), on page 28.

In remote control, the status reporting system stores all information on the current operating state and occurred errors. See:

- [Chapter 11.2, "Status Reporting System"](#), on page 93
- [Chapter 11.2, "Status Reporting System"](#), on page 93

Instrument information

Instrument information, including the installed hardware and software options, is available under [Chapter 9.2, "Instrument Info"](#), on page 73.

The hardware configuration is provided separately under [Chapter 9.3, "Hardware Configuration"](#), on page 81.

Sensor information

You can display information about one of the connected power sensors. See ["Sensor Info"](#) on page 71.

12.2 Notifications

The graphical user interface has a notification center where all information, warning and error messages are collected. See [Chapter 4.1.3, "Notification Center"](#), on page 31.

12.2.1 Interpreting Notifications and Their Number

In the following, important notifications and their meaning are explained. For all other notifications, perform tests to find out whether it is a hardware or software problem, and report the problem to the R&S customer support. See [Chapter 12.3, "Performing Tests"](#), on page 191.

In remote control, notifications and errors are associated with a unique number. Positive numbers are instrument-dependent. Negative numbers are reserved by the SCPI standard.

The notification types are grouped in number ranges. In the following description, both the number used in remote control and the description is given to help identify the problem.

12.2.1.1 System Notifications

Number range: 1000 to 1999. Described notifications:

1004 - firmware update error.....	190
1005 - settings conflict.....	190
1007 - target descriptor error.....	190
1008 - temperature alert.....	190
1009 - fan failure alert.....	191

1004 - firmware update error

Firmware update failed.

Possible reasons:

- You have used an *.rsu file that is not designated for the R&S NRT2. The name of a suitable *.rsu file starts with "NRT2".
- The firmware update was interrupted or otherwise faulty.

Solution: Perform the firmware update again. See [Chapter 10, "Firmware Update"](#), on page 85.

1005 - settings conflict

Settings conflict of the R&S NRT2 occurred.

Reason: Contradictory settings are allowed so that you are not hampered in your workflow.

Solution: Solve the settings conflict before starting a measurement.

1007 - target descriptor error

Servicing required. You cannot resolve the problem yourself.

Solution: Contact customer support. See [Chapter 12.5, "Contacting Customer Support"](#), on page 192.

1008 - temperature alert

R&S NRT2 is overheated. Overheating can damage the R&S NRT2.

Possible reasons:

- Insufficient airflow. Follow the instructions in [Chapter 3.1.4, "Setting Up the Product"](#), on page 16.
- The environmental temperature exceeds the suitable temperature range given in the data sheet under environmental conditions.
- The fan does not work properly. See [Chapter 12.5, "Contacting Customer Support"](#), on page 192.

1009 - fan failure alert

The fan does not work. Overheating can damage the R&S NRT2.

Solution: Switch off the R&S NRT2, and contact customer support. See [Chapter 12.5, "Contacting Customer Support"](#), on page 192.

12.2.1.2 Power Sensor Notifications

Number range: 2000 to 2999.

The power sensors report their error states to the R&S NRT2. The error states depend on the power sensor type.

2007 - sensor overload

The RF input power exceeds the measurement range by far.

Solution: Immediately disconnect the power sensor from the RF source to avoid damage. Use an attenuator or another power sensor that is suitable for the input level.

12.2.1.3 License Key Notifications

Number range: 4000 to 4999.

For all notifications not described here, collect information for technical support. See [Chapter 12.4, "Collecting Information for Technical Support"](#), on page 192. Described notifications:

[4001 - license key management warning](#).....191

4001 - license key management warning

Usually caused by:

- Problems with the system time. See ["Date and Time Settings"](#) on page 75.
- Wrong license key for a software option.

12.2.1.4 Queue Handling Notifications

Number range starts from 9000.

9001 - static error queue overflow

The queue of events has reached its maximum number of 1000 notices, warnings and errors. No more entries are created.

Solution: Solve the errors before continuing.

12.3 Performing Tests

Using the graphical user interface, you can test the following:

- User interface of the R&S NRT2, see [Chapter 9.4, "Test"](#), on page 82.
- Connected power sensors, see ["Sensor Test"](#) on page 72.

12.4 Collecting Information for Technical Support

If you encounter problems that you cannot solve yourself, contact your Rohde & Schwarz support center, see [Chapter 12.5, "Contacting Customer Support"](#), on page 192. Our support center staff is optimally trained to assist you in solving problems.

The support center finds solutions more quickly and efficiently if you provide them with information on the instrument and an error description.

Obtaining information from the R&S NRT2 firmware

1. Select [System] > "Test".
2. Create and save the information for troubleshooting. See ["Creating information for troubleshooting"](#) on page 83.

Attach the archive file to an email in which you describe the problem.

If you need to transport or ship the product, see [Chapter 13, "Transporting"](#), on page 193.

12.5 Contacting Customer Support

Technical support – where and when you need it

For quick, expert help with any Rohde & Schwarz product, contact our customer support center. A team of highly qualified engineers provides support and works with you to find a solution to your query on any aspect of the operation, programming or applications of Rohde & Schwarz products.

Contact information

Contact our customer support center at www.rohde-schwarz.com/support, or follow this QR code:



Figure 12-1: QR code to the Rohde & Schwarz support page

13 Transporting

Lifting and carrying

See:

- ["Lifting and carrying the product"](#) on page 10
- [Chapter 3.1.1, "Lifting and Carrying"](#), on page 15

Packing

Use the original packaging material. It consists of antistatic wrap for electrostatic protection and packing material designed for the product.

If you do not have the original packaging, use similar materials that provide the same level of protection.

Securing

When moving the product in a vehicle or using transporting equipment, make sure that the product is properly secured. Only use items intended for securing objects.

Transport altitude

Unless otherwise specified in the data sheet, the maximum transport altitude without pressure compensation is 4500 m above sea level.

14 Maintenance, Storage and Disposal

The product does not require regular maintenance. It only requires occasional cleaning. It is however advisable to check the nominal data from time to time.

14.1 Cleaning

How to clean the product is described in "[Cleaning the product](#)" on page 11.

Do not use any liquids for cleaning. Cleaning agents, solvents (thinners, acetone), acids and bases can damage the front panel labeling, plastic parts and display.

14.2 Storage

Protect the product against dust. Ensure that the environmental conditions, e.g. temperature range and climatic load, meet the values specified in the data sheet.

14.3 Disposal

Rohde & Schwarz is committed to making careful, ecologically sound use of natural resources and minimizing the environmental footprint of our products. Help us by disposing of waste in a way that causes minimum environmental impact.

Disposing electrical and electronic equipment

A product that is labeled as follows cannot be disposed of in normal household waste after it has come to the end of its service life. Even disposal via the municipal collection points for waste electrical and electronic equipment is not permitted.



Figure 14-1: Labeling in line with EU directive WEEE

Rohde & Schwarz has developed a disposal concept for the eco-friendly disposal or recycling of waste material. As a manufacturer, Rohde & Schwarz completely fulfills its obligation to take back and dispose of electrical and electronic waste. Contact your local service representative to dispose of the product.

Glossary: List of Abbreviations

A

AVG: Average

C

CCDF: Complementary cumulative distribution function

CDMA: Code division multiple access

D

DHCP: Dynamic host control protocol

DNS: Domain name system

E

EMC: Electromagnetic compatibility

EMI: Electromagnetic interference

G

GPIB: General purpose interface bus

H

HiSLIP: High-speed LAN instrument protocol

I

IDN: Instrument identification string

IP: Internet protocol

L

LAN: Local area network

O

OPT: Option identification string

OSA: Open source acknowledgement

P

PEP: Peak envelope power

S

SCPI: Standard commands for programmable instruments

SSH: Secure shell

SWR: Standing wave ratio

U

USB: Universal serial bus

V

VISA: Virtual instrument software architecture

VNC: Virtual network computing

W

WCDMA: Wideband code division multiple access

List of commands

[SENSe<Sensor>:] [POWer:] [AVG:] APERture[:VALue].....	150
[SENSe<Sensor>:] AVERAge:COUNT:AUTO[:STATe].....	148
[SENSe<Sensor>:] AVERAge:COUNT[:VALue].....	148
[SENSe<Sensor>:] BANDwidth:VIDeo:FNUMber.....	149
[SENSe<Sensor>:] BWIDth:VIDeo:FNUMber.....	149
[SENSe<Sensor>:] DATA?.....	153
[SENSe<Sensor>:] DM:STANdard.....	152
[SENSe<Sensor>:] DM:STATe.....	153
[SENSe<Sensor>:] DM:WCDMa:CRATe.....	153
[SENSe<Sensor>:] FREQUency:FIXed.....	151
[SENSe<Sensor>:] FREQUency[:CW].....	151
[SENSe<Sensor>:] FUNCTion:CONCurent.....	154
[SENSe<Sensor>:] FUNCTion:OFF:ALL<Channel>.....	154
[SENSe<Sensor>:] FUNCTion:OFF[:FUNC].....	154
[SENSe<Sensor>:] FUNCTion:STATe?.....	155
[SENSe<Sensor>:] FUNCTion[:ON].....	149
[SENSe<Sensor>:] INFormation?.....	155
[SENSe<Sensor>:] NAME.....	155
[SENSe<Sensor>:] POWer:CCDFunction:REFerence.....	155
[SENSe<Sensor>:] POWer:PEP:HOLD.....	158
[SENSe<Sensor>:] POWer:REFerence.....	160
[SENSe<Sensor>:] POWer:REFLection:RANGe:AUTO.....	156
[SENSe<Sensor>:] POWer:REFLection:RANGe:LIMit:DETeCt.....	156
[SENSe<Sensor>:] POWer:REFLection:RANGe:LIMit[:STATe].....	157
[SENSe<Sensor>:] POWer:REFLection:RANGe:LOWer.....	157
[SENSe<Sensor>:] POWer:REFLection:RANGe[:UPPer].....	157
[SENSe<Sensor>:] POWer[:POWer]:RANGe:AUTO.....	158
[SENSe<Sensor>:] POWer[:POWer]:RANGe:LIMit:DETeCt.....	158
[SENSe<Sensor>:] POWer[:POWer]:RANGe:LIMit[:STATe].....	159
[SENSe<Sensor>:] POWer[:POWer]:RANGe:LOWer.....	159
[SENSe<Sensor>:] POWer[:POWer]:RANGe[:UPPer].....	160
[SENSe<Sensor>:] RRRESolution.....	160
[SENSe<Sensor>:] SWR:LIMit.....	160
[SENSe<Sensor>:] SWR:SIGNal[:TTLSignal]:LEVel.....	161
*CLS.....	102
*DEV.....	103
*DMC.....	103
*EMC.....	103
*ESE.....	103
*ESR?.....	103
*GCLS.....	103
*GMC?.....	104
*GOPC?.....	104
*GWAi.....	104
*IDN?.....	104
*IST?.....	104
*LMC?.....	104

*OPC.....	105
*OPT?.....	105
*PMC.....	105
*PRE.....	105
*PSC.....	106
*RCL.....	106
*RMC.....	106
*RST.....	106
*SAV.....	106
*SRE.....	107
*SRQ?.....	107
*STB?.....	107
*TRG.....	107
*TST?.....	107
*WAI.....	108
*XESE.....	108
*XESR?.....	108
*XPRES.....	108
*XSRE.....	109
*XSTB?.....	109
&ABO.....	101
&DFC.....	101
&GET.....	101
>L.....	102
>M.....	102
>R.....	102
&HFC.....	102
&LLO.....	102
&NREN.....	102
CALCulate<Measurement>:DMODE.....	110
CALCulate<Measurement>:HOLD:FUNCTION.....	110
CALCulate<Measurement>:HOLD[:STATE].....	111
CALCulate<Measurement>:LIMIT:TYPE.....	130
CALCulate<Measurement>:LIMIT[:STATE].....	129
CALCulate<Measurement>:LIMIT<DirectionalChannel>:LOWER:STATE.....	111
CALCulate<Measurement>:LIMIT<DirectionalChannel>:LOWER[:DATA]:CCDF.....	111
CALCulate<Measurement>:LIMIT<DirectionalChannel>:LOWER[:DATA]:RATIO:RCoefficient.....	112
CALCulate<Measurement>:LIMIT<DirectionalChannel>:LOWER[:DATA]:RATIO:RFRatio.....	112
CALCulate<Measurement>:LIMIT<DirectionalChannel>:LOWER[:DATA]:RATIO:RLOSSs.....	112
CALCulate<Measurement>:LIMIT<DirectionalChannel>:LOWER[:DATA]:RATIO:SWR.....	113
CALCulate<Measurement>:LIMIT<DirectionalChannel>:LOWER[:DATA]:RATIO[:VALUE].....	113
CALCulate<Measurement>:LIMIT<DirectionalChannel>:LOWER[:DATA][:POWER].....	113
CALCulate<Measurement>:LIMIT<DirectionalChannel>:UPPER:STATE.....	113
CALCulate<Measurement>:LIMIT<DirectionalChannel>:UPPER[:DATA]:CCDF.....	114
CALCulate<Measurement>:LIMIT<DirectionalChannel>:UPPER[:DATA]:RATIO:RCoefficient.....	114
CALCulate<Measurement>:LIMIT<DirectionalChannel>:UPPER[:DATA]:RATIO:RFRatio.....	114
CALCulate<Measurement>:LIMIT<DirectionalChannel>:UPPER[:DATA]:RATIO:RLOSSs.....	115
CALCulate<Measurement>:LIMIT<DirectionalChannel>:UPPER[:DATA]:RATIO:SWR.....	115
CALCulate<Measurement>:LIMIT<DirectionalChannel>:UPPER[:DATA]:RATIO[:VALUE].....	115
CALCulate<Measurement>:LIMIT<DirectionalChannel>:UPPER[:DATA][:POWER].....	116

CALCulate<Measurement>:METer<DirectionalChannel>:LOWer[:DATA]:CCDF.....	116
CALCulate<Measurement>:METer<DirectionalChannel>:LOWer[:DATA]:RATio:RCoefficient.....	116
CALCulate<Measurement>:METer<DirectionalChannel>:LOWer[:DATA]:RATio:RFRatio.....	117
CALCulate<Measurement>:METer<DirectionalChannel>:LOWer[:DATA]:RATio:RLOSs.....	117
CALCulate<Measurement>:METer<DirectionalChannel>:LOWer[:DATA]:RATio:SWR.....	117
CALCulate<Measurement>:METer<DirectionalChannel>:LOWer[:DATA]:RATio[:VALue].....	118
CALCulate<Measurement>:METer<DirectionalChannel>:LOWer[:DATA][:POWER].....	118
CALCulate<Measurement>:METer<DirectionalChannel>:UPPer[:DATA]:CCDF.....	118
CALCulate<Measurement>:METer<DirectionalChannel>:UPPer[:DATA]:RATio:RCoefficient.....	119
CALCulate<Measurement>:METer<DirectionalChannel>:UPPer[:DATA]:RATio:RFRatio.....	119
CALCulate<Measurement>:METer<DirectionalChannel>:UPPer[:DATA]:RATio:RLOSs.....	119
CALCulate<Measurement>:METer<DirectionalChannel>:UPPer[:DATA]:RATio:SWR.....	120
CALCulate<Measurement>:METer<DirectionalChannel>:UPPer[:DATA]:RATio[:VALue].....	120
CALCulate<Measurement>:METer<DirectionalChannel>:UPPer[:DATA][:POWER].....	120
CALCulate<Measurement>:RELative<DirectionalChannel>:CCDF.....	121
CALCulate<Measurement>:RELative<DirectionalChannel>:POWER.....	121
CALCulate<Measurement>:RELative<DirectionalChannel>:RATio:RCoefficient.....	121
CALCulate<Measurement>:RELative<DirectionalChannel>:RATio:RFRatio.....	122
CALCulate<Measurement>:RELative<DirectionalChannel>:RATio:RLOSs.....	122
CALCulate<Measurement>:RELative<DirectionalChannel>:RATio:SWR.....	122
CALCulate<Measurement>:RELative<DirectionalChannel>:RATio[:VALue].....	123
CALCulate<Measurement>:RELative<DirectionalChannel>[:STATE].....	123
CALCulate<Measurement>:RESolution.....	123
CALCulate<Measurement>[:CHANnel<Channel>]:AVERage:COUNT:AUTO[:STATE].....	124
CALCulate<Measurement>[:CHANnel<Channel>]:AVERage:COUNT[:VALue].....	124
CALCulate<Measurement>[:CHANnel<Channel>]:CORRection:OFFSet:RPLane.....	124
CALCulate<Measurement>[:CHANnel<Channel>]:CORRection:OFFSet:STATE.....	125
CALCulate<Measurement>[:CHANnel<Channel>]:CORRection:OFFSet[:MAGNitude].....	125
CALCulate<Measurement>[:CHANnel<Channel>]:FEED.....	125
CALCulate<Measurement>[:CHANnel<Channel>]:NRT:APERture:MODE.....	126
CALCulate<Measurement>[:CHANnel<Channel>]:NRT:APERture[:VALue].....	126
CALCulate<Measurement>[:CHANnel<Channel>]:NRT:BURSt:MODE.....	126
CALCulate<Measurement>[:CHANnel<Channel>]:NRT:BURSt:PERiod.....	127
CALCulate<Measurement>[:CHANnel<Channel>]:NRT:BURSt:WIDTh.....	127
CALCulate<Measurement>[:CHANnel<Channel>]:NRT:CCDF:THReshold.....	127
CALCulate<Measurement>[:CHANnel<Channel>]:NRT:DIRection.....	128
CALCulate<Measurement>[:CHANnel<Channel>]:NRT:DMODulation:WCDMa:CRATe.....	128
CALCulate<Measurement>[:CHANnel<Channel>]:NRT:DMODulation[:VALue].....	128
CALCulate<Measurement>[:CHANnel<Channel>]:NRT:PEP:HOLD:TIME.....	129
CALCulate<Measurement>[:CHANnel<Channel>]:NRT:VBWidTh[:VALue].....	129
CALibration<Sensor>:ZERO.....	130
DIAGnostic:INFO:OTIME?.....	130
FORMat:SREGister.....	131
FORMat[:DATA].....	131
FREQUency<Sensor>.....	131
INPut<Sensor>:PORT:OFFSet.....	132
INPut<Sensor>:PORT:POSition.....	132
INPut<Sensor>:PORT:SOURce:AUTO.....	133
INPut<Sensor>:PORT:SOURce[:VALue].....	132
MMEMory:ALlases?.....	134

MMEMory:ATTRibute.....	134
MMEMory:CATalog:LENGth?.....	135
MMEMory:CATalog?.....	135
MMEMory:CDIRectory.....	136
MMEMory:COpy.....	136
MMEMory:DATA.....	136
MMEMory:DCATalog:LENGth?.....	138
MMEMory:DCATalog?.....	137
MMEMory:DELeTe.....	138
MMEMory:DRIVes?.....	138
MMEMory:LOAD:ITEM.....	138
MMEMory:LOAD:MACRo.....	139
MMEMory:LOAD:STATe.....	139
MMEMory:MDIRectory.....	139
MMEMory:MOVE.....	140
MMEMory:MSIS.....	140
MMEMory:RCL.....	140
MMEMory:RDIRectory.....	141
MMEMory:SAV.....	140
MMEMory:STORe:ITEM.....	141
MMEMory:STORe:MACRo.....	141
MMEMory:STORe:STATe.....	141
OUTPut:LIMit:FAIL.....	142
OUTPut:MODE<output>.....	142
OUTPut:REcorder<output>:LIMit:LOWer:CCDF.....	145
OUTPut:REcorder<output>:LIMit:LOWer:RATio:RCoefficient.....	145
OUTPut:REcorder<output>:LIMit:LOWer:RATio:RFRatio.....	145
OUTPut:REcorder<output>:LIMit:LOWer:RATio:RLOSSs.....	145
OUTPut:REcorder<output>:LIMit:LOWer:RATio:SWR.....	146
OUTPut:REcorder<output>:LIMit:LOWer:RATio[:VALue].....	143
OUTPut:REcorder<output>:LIMit:LOWer[:POWER].....	144
OUTPut:REcorder<output>:LIMit:UPPer:CCDF.....	146
OUTPut:REcorder<output>:LIMit:UPPer:RATio:RCoefficient.....	146
OUTPut:REcorder<output>:LIMit:UPPer:RATio:RFRatio.....	147
OUTPut:REcorder<output>:LIMit:UPPer:RATio:RLOSSs.....	147
OUTPut:REcorder<output>:LIMit:UPPer:RATio:SWR.....	147
OUTPut:REcorder<output>:LIMit:UPPer:RATio[:VALue].....	144
OUTPut:REcorder<output>:LIMit:UPPer[:POWER].....	144
SENSe<Sensor>:BURSt:MODE.....	151
SENSe<Sensor>:BURSt:PERiod.....	152
SENSe<Sensor>:BURSt:WIDTh.....	152
SERVice:UNLock.....	161
STATus:OPERation:BIT<bitno>:CONDition?.....	162
STATus:OPERation:BIT<bitno>:ENABle.....	162
STATus:OPERation:BIT<bitno>:NTRansition.....	163
STATus:OPERation:BIT<bitno>:PTRansition.....	163
STATus:OPERation:BIT<bitno>[:EVENT]?.....	163
STATus:OPERation:CONDition?.....	162
STATus:OPERation:ENABle.....	162
STATus:OPERation:NTRansition.....	162

STATus:OPERation:PTRansition.....	162
STATus:OPERation[:EVENT]?.....	162
STATus:PRESet.....	163
STATus:QUEStionable:BIT<bitno>:CONDition?.....	164
STATus:QUEStionable:BIT<bitno>:ENABle.....	164
STATus:QUEStionable:BIT<bitno>:NTRansition.....	164
STATus:QUEStionable:BIT<bitno>:PTRansition.....	164
STATus:QUEStionable:BIT<bitno>[:EVENT]?.....	165
STATus:QUEStionable:CONDition?.....	163
STATus:QUEStionable:ENABle.....	163
STATus:QUEStionable:NTRansition.....	164
STATus:QUEStionable:PTRansition.....	164
STATus:QUEStionable[:EVENT]?.....	164
STATus:QUEue[:NEXT]?.....	165
SYSTem:COMMunicate:GPIB[:SELF]:ADDResS.....	167
SYSTem:COMMunicate:INET[:SELF]:ADDResS.....	167
SYSTem:COMMunicate:INET[:SELF]:DNS:ADDResS.....	168
SYSTem:COMMunicate:INET[:SELF]:DNS:SUFFix.....	169
SYSTem:COMMunicate:INET[:SELF]:GATeway:ADDResS.....	168
SYSTem:COMMunicate:INET[:SELF]:MODE.....	167
SYSTem:COMMunicate:INET[:SELF]:SUBNetmask:ADDResS.....	168
SYSTem:COMMunicate:NETWork:MACAddress?.....	170
SYSTem:COMMunicate:NETWork:REStart.....	170
SYSTem:COMMunicate:NETWork:STATus?.....	170
SYSTem:COMMunicate:NETWork[:COMMon]:DOMain.....	169
SYSTem:COMMunicate:NETWork[:COMMon]:HOSTname.....	169
SYSTem:COMMunicate:NETWork[:COMMon]:WORKgroup.....	169
SYSTem:COMMunicate:NETWork[:IPADdress]:DNS.....	168
SYSTem:COMMunicate:NETWork[:IPADdress]:GATeway.....	168
SYSTem:COMMunicate:NETWork[:IPADdress]:MODE.....	167
SYSTem:COMMunicate:NETWork[:IPADdress]:SUBNet:MASK.....	168
SYSTem:COMMunicate:NETWork[:IPADdress][:ADDResS].....	167
SYSTem:DATE.....	170
SYSTem:DEVIce:ID?.....	170
SYSTem:DFPPrint.....	171
SYSTem:DFPPrint:HISTory:COUNT?.....	171
SYSTem:DFPPrint:HISTory:ENTRY?.....	171
SYSTem:DID?.....	171
SYSTem:DISPlay:UPDate.....	171
SYSTem:ERRor:ALL?.....	174
SYSTem:ERRor:CODE:ALL?.....	174
SYSTem:ERRor:CODE[:NEXT]?.....	175
SYSTem:ERRor:COUNT?.....	175
SYSTem:ERRor[:NEXT]?.....	175
SYSTem:FWUPdate.....	176
SYSTem:FWUPdate:STATus?.....	177
SYSTem:HCOPY.....	175
SYSTem:HELP:HEADers?.....	177
SYSTem:HELP:SYNTax:ALL?.....	178
SYSTem:HELP:SYNTax?.....	178

SYSTem:IDN:ANSWer.....	172
SYSTem:IDN:AUTO.....	173
SYSTem:IDN:MODE.....	172
SYSTem:INFO:TERMchar.....	176
SYSTem:INFO[:INFO]?.....	172
SYSTem:KLOCK.....	178
SYSTem:LOCK:NAME:DETAiled?.....	178
SYSTem:LOCK:NAME?.....	178
SYSTem:LOCK:OWNer:DETAiled?.....	179
SYSTem:LOCK:OWNer?.....	178
SYSTem:LOCK:RELease.....	179
SYSTem:LOCK:RELease:ALL.....	179
SYSTem:LOCK:REQuest:SHARed?.....	179
SYSTem:LOCK:REQuest[:EXCLusive]?.....	179
SYSTem:LOCK:SHARed:STRing?.....	180
SYSTem:LOCK:TIMEout.....	180
SYSTem:OPT:ANSWer.....	173
SYSTem:OPT:AUTO.....	174
SYSTem:OPT:MODE.....	173
SYSTem:PRESet.....	174
SYSTem:REBoot.....	174
SYSTem:SERRor:LIST:ALL?.....	181
SYSTem:SERRor:REMove.....	180
SYSTem:SERRor?.....	180
SYSTem:SERRor[:ALL]?.....	180
SYSTem:SHUTdown.....	181
SYSTem:SPEEd.....	174
SYSTem:TIME:DSTime:MODE.....	181
SYSTem:TIME:DSTime:RULE.....	181
SYSTem:TIME:DSTime:RULE:CATalog?.....	181
SYSTem:TIME:HRTimer:ABSolute.....	181
SYSTem:TIME:HRTimer:ABSolute:SET.....	182
SYSTem:TIME:HRTimer:RELative.....	182
SYSTem:TZONE.....	182
SYSTem:VERSion?.....	176
SYSTem:VERSion?.....	182
TEST:ALL?.....	183
TEST:DIRect.....	183
TEST:FRAM?.....	184
TEST:RAM?.....	184
TEST:ROM?.....	184
TEST:SENSor<Sensor>?.....	183
TRIGger<Measurement>:MODE.....	185
TRIGger<Measurement>:SOURce.....	185
TRIGger<Measurement>[:IMMediate].....	184
UNIT<Measurement>:POWer:RATio.....	186
UNIT<Measurement>:POWer:REFLection.....	187
UNIT<Measurement>:POWer:RELative:STATe.....	187
UNIT<Measurement>:POWer:RELative[:VALue].....	188
UNIT<Measurement>:POWer[:VALue].....	186

Index

Symbols

1 Trig key 23

A

AC power supply 26
 Connecting to 18
 Available Sensors dialog 70

B

Bench top operation 16
 Brochures 13

C

Carrying 15
 Channel
 Configuration 50
 Correction 52
 Filter 55
 Frequency 54
 Mode 50
 Channel Filter Configuration dialog 55
 Checking 15
 Cleaning 194
 CONDition 95
 Connecting
 External devices 20
 LAN 19
 Power supply 18
 Sensor 19
 Connections tab 61
 Connector
 AC power supply 26
 NRT Sensor 22
 Out 1 / Trig Out 25
 Trig In / Out 2 25
 Control
 Measurement 44
 Cursor keys 24
 Customer support 192
 Collecting information 192

D

Data sheets 13
 Date and Time dialog 75
 Default settings 58
 Delete key 23
 Details tab 80
 Device ID 27
 Diagnostics
 Tests 191
 Dialog
 Main measurement 36
 Measurement Main Configuration 43
 Measurement Overview 42
 Measurement Representation 46
 Display
 Configuration 36
 Display settings 46
 Disposal 194

Documentation overview 13

E

Electromagnetic interference (EMI) 18
 Electrostatic discharge (ESD) 18
 EMI 18
 Emulations tab 67
 ENABle 96
 Enable register 98
 Enter key 23
 Error message
 Number 189
 Errors
 Displaying 32
 Esc key 23
 ESD 18
 ESE 98
 ESR 98
 Ethernet interface 26
 EVENT 96
 External devices 20

F

Favorites key 24
 Firmware
 update 85
 Freq key 24
 Front panel 22
 Front panel keys 23

G

General tab 76
 Getting started 13
 Global Settings tab 83
 Going back to the previous level 28

H

Hardware Config tab 81
 Help 13
 Hierarchy level
 Changing 28
 Hostname 63
 Default 27
 HW Options tab 79

I

I/O dialog 68
 IEC 625/IEEE 488 interface 26
 Initial state
 Preset 58
 Instrument identification string 67
 Instrument info tab 73
 Instrument security procedures 13
 Instrument settings 57
 Instrument test 82
 Intended use 9
 Interface
 Ethernet 26
 IEC 625/IEEE 488 26

- USB device 26
- USB host 26
- K**
- Key 23
 - 1 Trig 23
 - Delete 23
 - Enter 23
 - Esc 23
 - Favorites 24
 - Freq 24
 - Local 23
 - On/standby 25
 - Preset 24
 - Screenshot 23
 - System 24
 - Zero 24
- Keywords
 - optional 92
- L**
- Labels 11
- LAN connection 19
- LAN Settings tab 77
- Lifting 15
- Local key 23
- M**
- Main measurement dialog 28, 36
- Maintenance 194
 - Cleaning 194
- Manual operation 28
 - Returning to 35
- Measurement
 - Configuration 36, 42
 - Control 44
 - Overview 42
 - Representation 46
- Measurement Main Configuration dialog 43
- Measurement Overview dialog 42
- Measurement Representation dialog 46
- Messages
 - Deleting 32
 - Displaying 32
- N**
- Network
 - Overview 63
- Network dialog 62
- Notification 189
 - Number 189
- Notification center 31
 - Symbols 31
- NRT Sensor
 - Connector 22
- NTRansition 95
- O**
- On/standby key 25
- Open source acknowledgment (OSA) 14
- Open source license 81
- Open Source Licenses dialog 81
- Operating concepts
 - Manual operation 28
 - Remote control 34
- Operating conditions 15
- Operating site 15
- Operation status register 99
- Option
 - Details 80
 - Hardware 79
- Option identification string 67
- Options dialog 79
- Out 1 / Trig Out connector 25
- Overview tab 63
- P**
- Parallel poll enable register 97
- Parameters
 - Editing 33
- Password
 - Security 78
- Power supply
 - Connecting to 18
- PPE 97
- Preparing for use 15
- Preset 57, 58
- Preset key 24
- PTRansition 95
- Q**
- Questionable status register 97
- R**
- Rack mounting 17
- Rear panel 25
- Recall
 - Settings 57
- Release notes 14
- Remote control 34
 - Changing to 34
 - Leaving 35
- Remote dialog 65
- Remote settings
 - Emulations 67
 - Settings 66
 - VISA Resource 66
- Representation 36, 46
- S**
- Safety information 9
- Safety instructions 9, 13
- Save
 - Settings 57
- Save and recall 57
- SCPI status register
 - Structure 94
- Screenshot key 23
- Screenshots
 - Creating 33
 - Saving 33
- Security
 - General settings 76
 - LAN settings 77
 - Security password 78

Security dialog	76
Security Password tab	78
Security procedures	13
Selftest	191
Sensor	
Connecting	19
Connector	22
Zeroing	59
Sensor Frequency dialog	54
Sensor Info dialog	71
Sensor settings	57
Sensor Test dialog	72
Sensors	
Available	70
Serial number	27
Service request enable register	96
Setting up	16
Settings	
Input/Output	68
Network	62
Open source licenses	81
Options	79
Remote	65
Security	76
Sensor manager	70
System	61
System info	73
Trigger	46
Settings tab	66
Software update	
see firmware	85
Sources	
Trigger	45
Special characters	
SCPI	93
SRE	96
Standard event status register	98
Status	
Information	189
Status byte register	96
Status information	30
Status register	94
CONDition	95
ENABLE	96
Enable register	98
EVENT	96
Hierarchy	93
IST flag	97
NTRansition	95
Operation status register	99
Parallel poll enable register	97
PTRansition	95
Questionable status register	97
Service request enable register	96
Standard event status register	98
Status byte register	96
Sum bit	96
Status reporting system	93
STB	96
Stock number	27
Storage	194
Suffixes	92
Sum bit	96
Support information	83
Switching on	21
Symbols	
Notification center	31
Status information	30
System Info dialog	73
System key	24
System Overview dialog	61
Connections	61
Global settings	83
Hardware configuration	81
Instrument info	73
Test	82
System settings	61
T	
Tab	
Instrument info	73
Target audience	9
Test setup	18
Test tab	82
Tests	191
Touchscreen	22
Transporting	193
Trig In / Out 2 connector	25
Trigger	
Sources	45
States	45
Trigger settings	46
Troubleshooting	189
Information	83
Notification	189
Status information	189
Tests	191
U	
Unpacking	15
USB	
Device interface	26
Host interface	24, 26
User interface	28
Going back	28
Main measurement dialog	28, 36
Measurement pane	29
Notification center	31
Parameters	33
Screenshots	33
Status information	30
User interface test	82
User manual	13
V	
VISA Resource tab	66
W	
Warning message	12
Number	189
Z	
Zero key	24
Zeroing sensor	59
Zeroing Sensors dialog	59