

E5080B ENA Series Vector Network Analyzer

9 kHz to 53 GHz, 2/4-port

Drive down the cost of test

9 kHz to 4.5/6.5/9/14/18/20 GHz

100 kHz to 26.5/32/44/53 GHz



E5080B ENA Series Vector Network Analyzer

As devices become highly integrated, complete characterization requires a complete RF and microwave measurement solution. The E5080B brings R&D performance up to 53 GHz¹ and flexibility to a midrange platform. Best-in-class dynamic range, trace noise, and temperature stability guarantee reliability and repeatability. Test consistently across your entire workflow with the same UI and SCPI commands as high-end PNAs.

The E5080B enables complete device characterization for passive components, amplifiers, mixers, and frequency converters. You can perform more tests with one box with integrated features such as DC sources, bias tees, pulse generators, pulse modulators, and internal second source². Gain deeper insights with software applications including spectrum analysis, mixer measurements, and noise figure. Choose from a 2- or 4-port option with frequency coverage from 9 kHz up to 20 GHz or for higher frequencies, 100 kHz up to 53 GHz.

The E5080B utilizes the same measurement science as other Keysight vector network analyzers (VNAs) such as the PNA, PXI, and USB VNA. A common software platform makes it easy to choose the right level of performance to match budget and measurement needs. This commonality guarantees measurement consistency, repeatability, and a common remote-programming interface across multiple instruments in R&D and manufacturing.



1. It is settable up to 54 GHz on the 53 GHz options.
2. Only available on 4-port configurations.

Table of Content

E5080B ENA Series Vector Network Analyzer	2
Definitions.....	4
Dynamic Range.....	5
Corrected System Performance.....	6
Uncorrected System Performance.....	15
Test Port Output.....	18
Test Port Input.....	23
Pulsed-RF Measurements (with Option 021/022 and S96025B/A)	41
Enhanced Time Domain Analysis with TDR (with S96011B/A).....	47
Impedance Analysis (with S96041B)	49
General Information	50
Measurement Throughput Summary	61
E5080B Test Set Block Diagrams.....	63
E5092A Configurable Multiport Test Set.....	66
Literature Information.....	71
Web Resources.....	71

Definitions

Specification (spec)¹

Warranted performance. Specifications include guardbands to account for the expected statistical performance distribution, measurement uncertainties, and changes in performance due to environmental conditions. All specifications and characteristics apply over a $25\text{ °C} \pm 5\text{ °C}$ range (unless otherwise stated).

The following conditions must be met:

- Instrument has been turned on for 90 minutes with VNA application running.
- Instrument is within its calibration cycle.
- Instrument remains at a stable surrounding environment temperature (between 0 °C to 40 °C) for 60 minutes prior to turn-on.

Characteristics (char.)

A performance parameter that the product is expected to meet before it leaves the factory, but that is not verified in the field and is not covered by the product warranty. A characteristic includes the same guardbands as a specification.

Typical (typ.)

Expected performance of an average unit at a stable temperature between $25\text{ °C} \pm 5\text{ °C}$ for 60 minutes prior to turn-on and during operation; does not include guardbands. It is not covered by the product warranty. The instrument must be within its calibration cycle.

Nominal (nom.)

A general, descriptive term or design parameter. It is not tested, and not covered by the product warranty.

Supplemental Information

A performance parameter that is tested on sampled product during design validation. It does not include guardbands and is not covered by the product warranty.

Calibration

The process of measuring known standards to characterize an instrument's systematic (repeatable) errors.

Corrected (residual)

Indicates performance after error correction (calibration). It is determined by the quality of calibration standards and how well "known" they are, plus system repeatability, stability, and noise.

Uncorrected (raw)

Indicates instrument performance without error correction. The uncorrected performance affects the stability of a calibration.

1. For all tables in this data sheet, the specified performance at the exact frequency of a break is the better value of the two specifications at that frequency.

Dynamic Range

The specifications in this section apply to measurements made with the Keysight E5080B ENA Series vector network analyzer under the following conditions:

- No averaging applied to data

Table 1. System Dynamic Range at Test Port (dB)¹

Option 240/260/290/2D0/2H0/2K0/440/460/490/4D0/4H0/4K0/442/462/492/4D2/4H2/4K2 (without bias tee options)

Description	Specification	Typical
9 kHz to 100 kHz	101	111
100 kHz to 300 kHz	117	126
300 kHz to 1 MHz	125	136
1 MHz to 10 MHz	130	141
10 MHz to 50 MHz ²	137	147
50 MHz to 3 GHz	140	150
3 GHz to 5 GHz	140	149
5 GHz to 6.5 GHz	140	148
6.5 GHz to 9 GHz	136	146
9 GHz to 14 GHz	133	142
14 GHz to 16 GHz	130	140
16 GHz to 20 GHz	126	137

Option 2L0/2M0/2N0/2P0/4L0/4M0/4N0/4P0/4L2/4M2/4N2/4P2

Description	Specification	Typical
100 kHz to 300 kHz	95	106
300 kHz to 500 kHz	104	120
500 kHz to 1 MHz	117	130
1 MHz to 10 MHz	125	138
10 MHz to 50 MHz ²	137	147
50 MHz to 6.5 GHz	140	150
6.5 GHz to 8 GHz	138	150
8 GHz to 9 GHz	138	147
9 GHz to 16 GHz	137	147
16 GHz to 17 GHz	137	143
17 GHz to 20 GHz	132	143
20 GHz to 24 GHz	130	143
24 GHz to 25 GHz	130	141
25 GHz to 26 GHz	127	141
26 GHz to 30 GHz	127	137
30 GHz to 35 GHz	122	137
35 GHz to 40 GHz	122	134
40 GHz to 45 GHz	122	132
45 GHz to 50 GHz	99	114
50 GHz to 53 GHz	71	100

1. System dynamic range = source maximum output power minus receiver noise floor at 10 Hz IF bandwidth. Does not include crosstalk effects.
2. It may typically be degraded at 25 MHz.

Option 240/260/290/2D0/2H0/2K0/440/460/490/4D0/4H0/4K0/442/462/492/4D2/4H2/4K2 with bias tee options (Option 120 or 140)

Description	Specification	Typical
9 kHz to 100 kHz	99	110
100 kHz to 300 kHz	116	125
300 kHz to 1 MHz	124	135
1 MHz to 10 MHz	129	140
10 MHz to 50 MHz ²	136	146
50 MHz to 2 GHz	138	150
2 GHz to 3 GHz	138	148
3 GHz to 4.5 GHz	138	147
4.5 GHz to 6.5 GHz	136	145
6.5 GHz to 9 GHz	133	144
9 GHz to 14 GHz	130	140
14 GHz to 16 GHz	126	137
16 GHz to 20 GHz	121	133

Corrected System Performance

This section provides specifications for the corrected performance of the E5080B ENA Series VNA using either of the 85032F, 85052D, 85058B Mechanical Calibration Kit or the N4691D, N4694D Electronic Calibration (ECal) Module. To determine transmission and reflection uncertainty curves with other calibration kits, please download Uncertainty Calculator from http://www.keysight.com/find/na_calculator to generate the curves for your specific calibration kit.

Measured with 10 Hz IF bandwidth, no averaging applied to data, environmental temperature = 23 °C (± 3 °C) with < 1 °C deviation from calibration temperature.

Table 2. Option 240/260/290/2D0/2H0/2K0/440/460/490/4D0/4H0/4K0/442/462/492/4D2/4H2/4K2 (without bias tee options) with 85032F Standard Mechanical Calibration Kit

Corrected error terms (dB) – Specifications

Description	9 kHz to 50 MHz	50 MHz to 3 GHz	3 GHz to 6 GHz	6 GHz to 9 GHz
Directivity	49	46	40	38
Source match	41	40	36	35
Load match	47	46	40	38
Reflection tracking	± 0.011	± 0.021	± 0.032	± 0.054
Transmission tracking	± 0.082	± 0.021	± 0.063	± 0.074

Transmission Uncertainty (magnitude and phase)

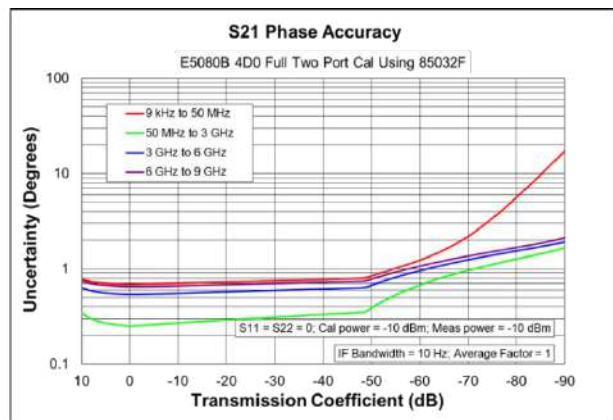
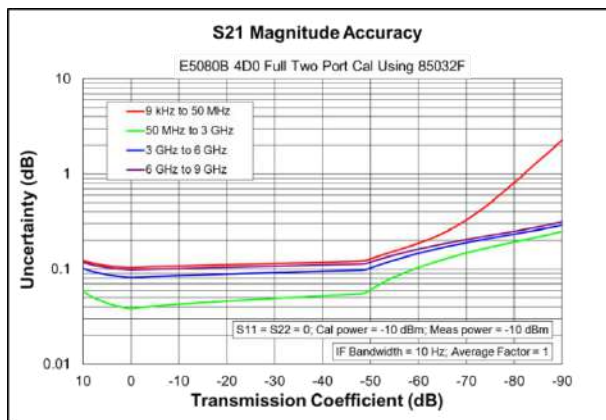

Reflection Uncertainty (magnitude and phase)

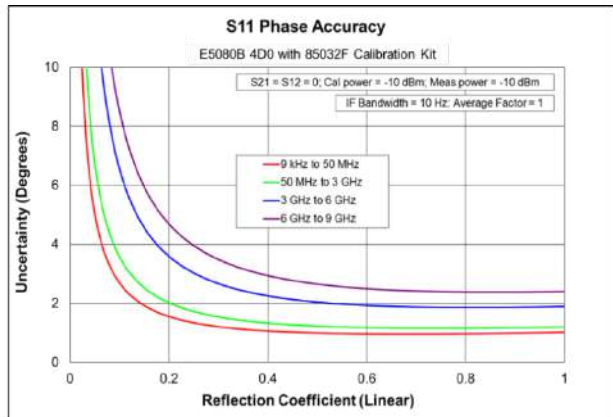
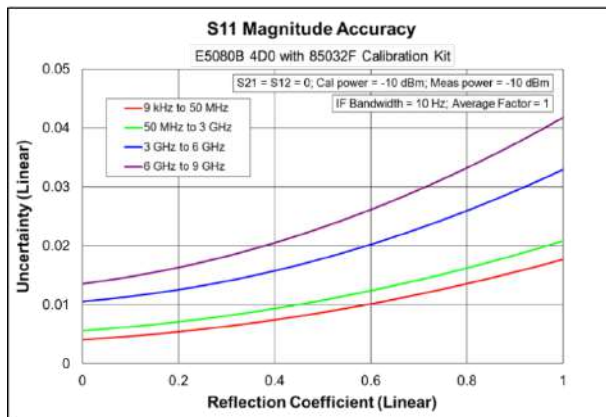
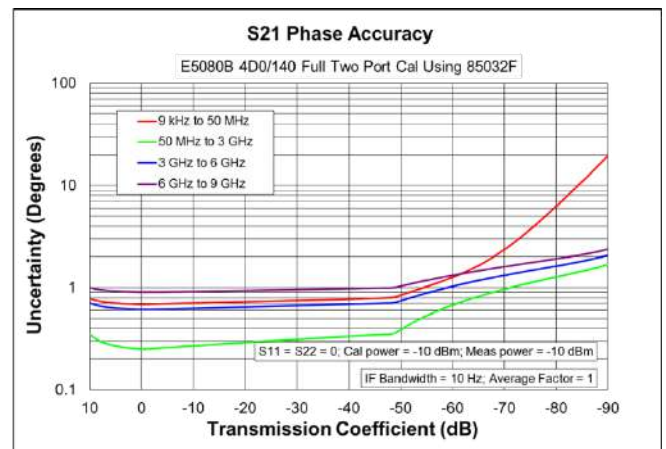
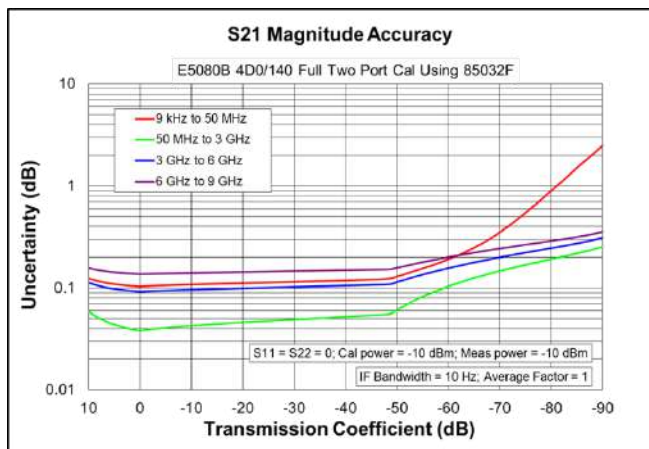

Table 3. Option 240/260/290/2D0/2H0/2K0/440/460/490/4D0/4H0/4K0/442/462/492/4D2/4H2/4K2 with bias tee options (Option 120 or 140) with 85032F Standard Mechanical Calibration Kit

Corrected error terms (dB) – Specifications

Description	9 kHz to 50 MHz	50 MHz to 3 GHz	3 GHz to 6 GHz	6 GHz to 9 GHz
Directivity	49	46	40	38
Source match	41	40	36	35
Load match	47	46	39	36
Reflection tracking	± 0.011	± 0.021	± 0.032	± 0.054
Transmission tracking	± 0.082	± 0.021	± 0.074	± 0.113

Transmission Uncertainty (magnitude and phase)



Reflection Uncertainty (magnitude and phase)

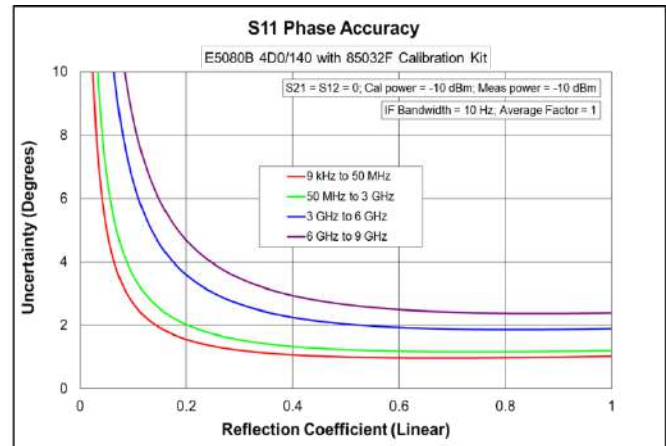
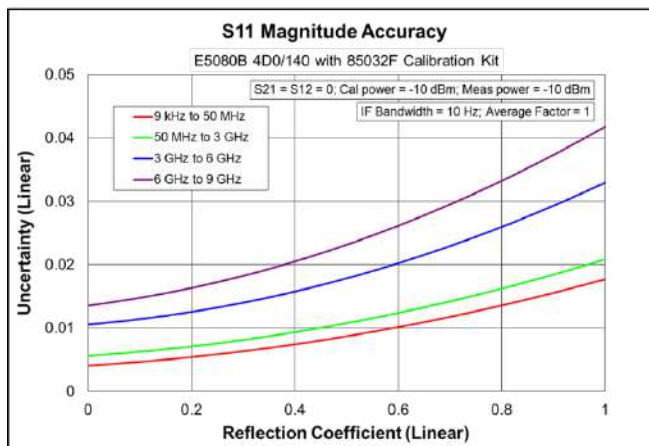
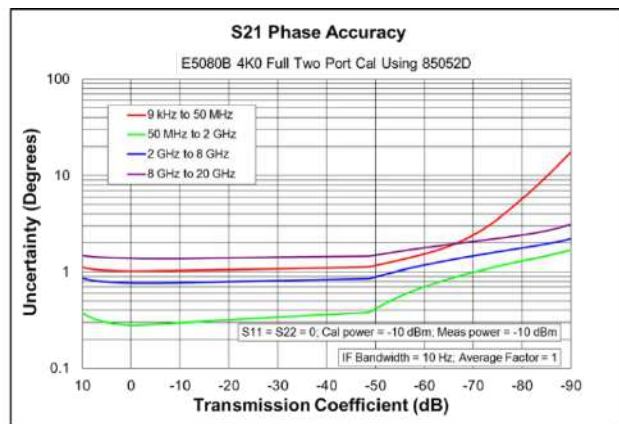
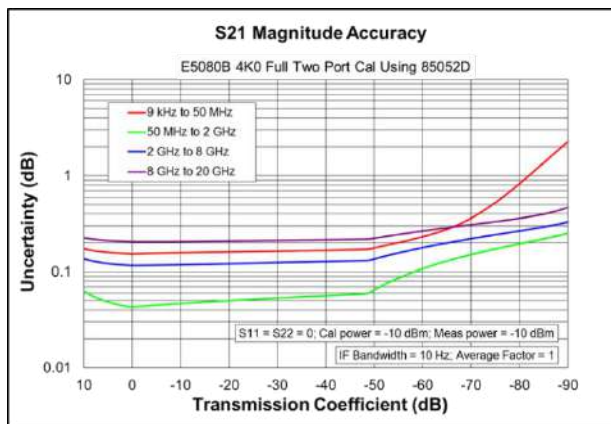

Table 4. Option 240/260/290/2D0/2H0/2K0/440/460/490/4D0/4H0/4K0/442/462/492/4D2/4H2/4K2 (without bias tee options) with 85052D Economy Mechanical Calibration Kit

Corrected error terms (dB) – Specifications

Description	9 kHz to 50 MHz	50 MHz to 2 GHz	2 GHz to 8 GHz	8 GHz to 20 GHz
Directivity	42	42	38	36
Source match	37	37	31	28
Load match	42	42	38	36
Reflection tracking	± 0.003	± 0.003	± 0.004	± 0.008
Transmission tracking	± 0.136	± 0.03	± 0.1	± 0.185

Transmission Uncertainty (magnitude and phase)



Reflection Uncertainty (magnitude and phase)

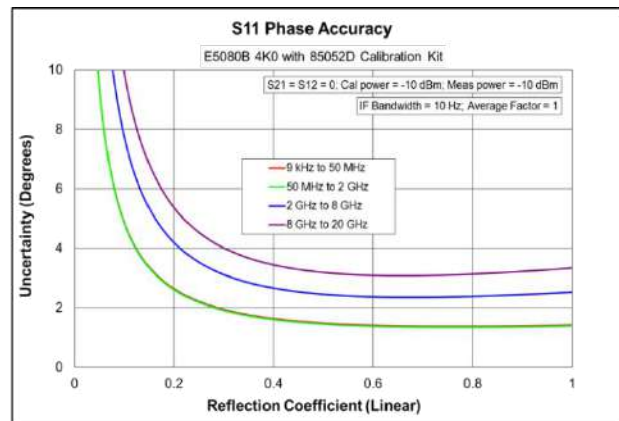
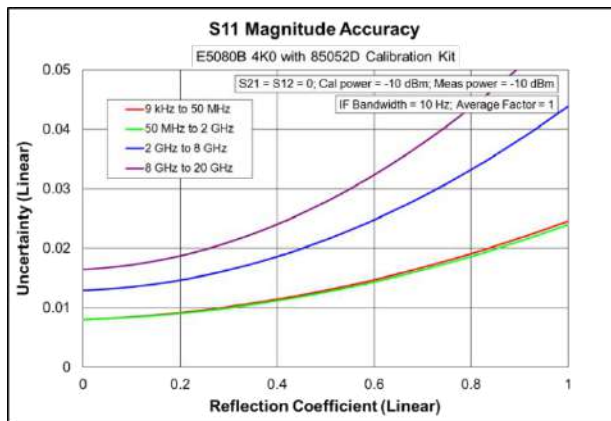
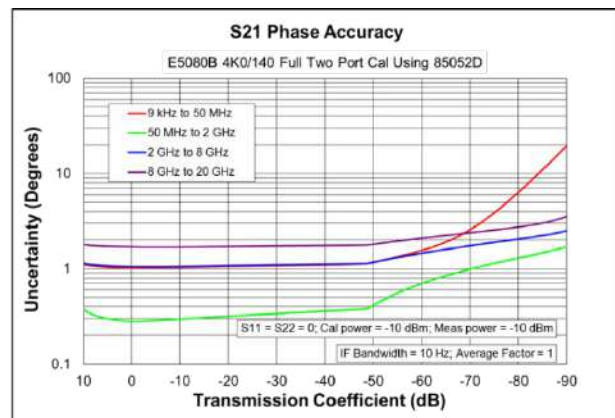
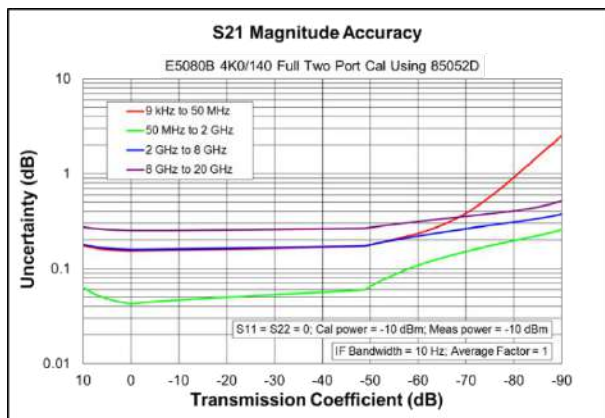

Table 5. Option 240/260/290/2D0/2H0/2K0/440/460/490/4D0/4H0/4K0/442/462/492/4D2/4H2/4K2 with bias tee options (Option 120 or 140) with 85052D Economy Mechanical Calibration Kit

Corrected error terms (dB) – Specifications

Description	9 kHz to 50 MHz	50 MHz to 2 GHz	2 GHz to 8 GHz	8 GHz to 20 GHz
Directivity	42	42	38	36
Source match	37	37	31	28
Load match	42	42	38	36
Reflection tracking	± 0.003	± 0.003	± 0.004	± 0.008
Transmission tracking	± 0.136	± 0.03	± 0.141	± 0.233

Transmission Uncertainty (magnitude and phase)



Reflection Uncertainty (magnitude and phase)

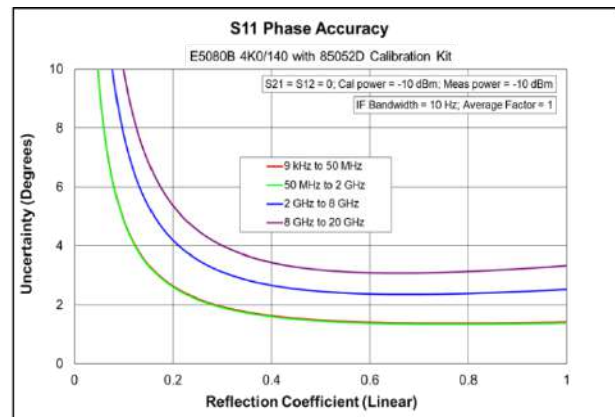
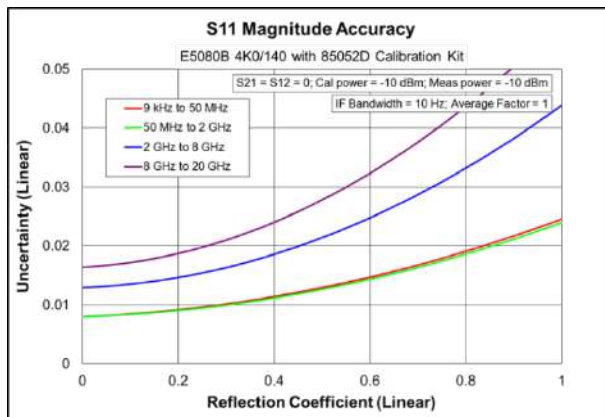
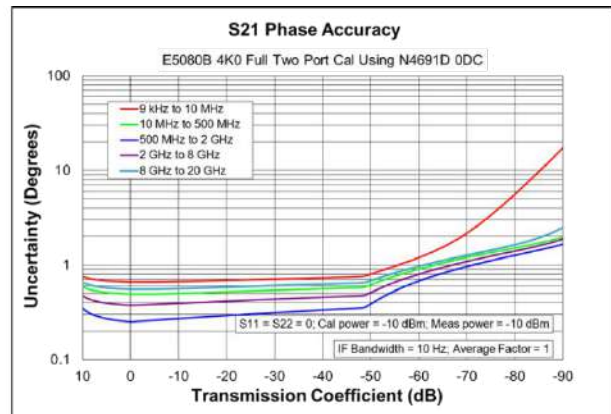
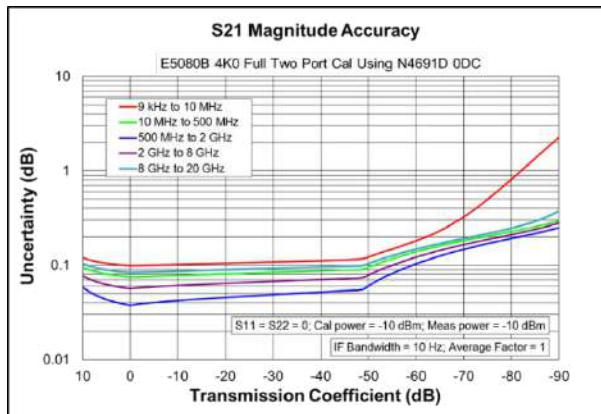

Table 6. Option 240/260/290/2D0/2H0/2K0/440/460/490/4D0/4H0/4K0/442/462/492/4D2/4H2/4K2 (without bias tee options) with N4691D Electronic Calibration (ECal) Module with Option 0DC

Corrected Error Terms (dB) – Specifications

Description	9 kHz to 10 MHz	10 MHz to 500 MHz	500 MHz to 2 GHz	2 GHz to 8 GHz	8 GHz to 20 GHz
Directivity	46	46	47	46	43
Source match	41	41	47	45	42
Load match	38	40	46	44	40
Reflection tracking	± 0.05	± 0.05	± 0.002	± 0.03	± 0.04
Transmission tracking	± 0.081	± 0.056	± 0.026	± 0.042	± 0.064

Transmission Uncertainty (magnitude and phase)



Reflection Uncertainty (magnitude and phase)

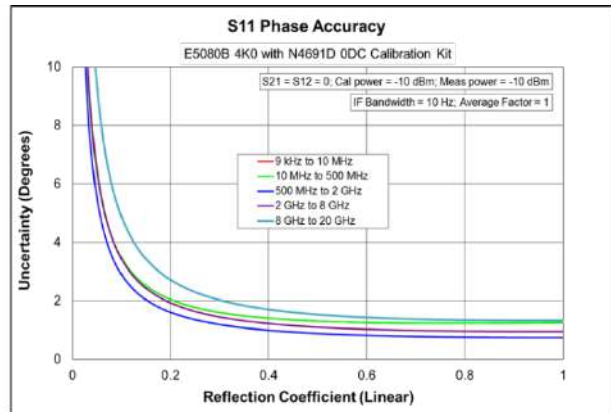
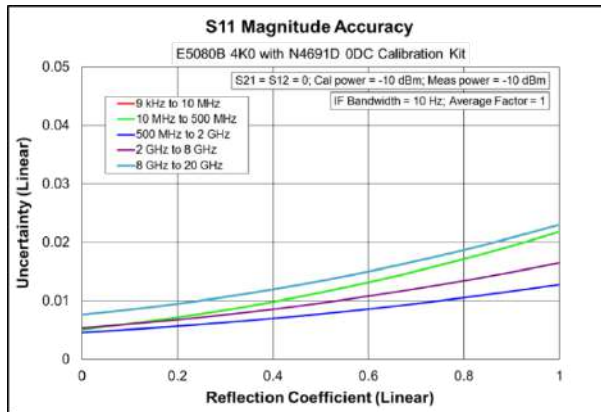
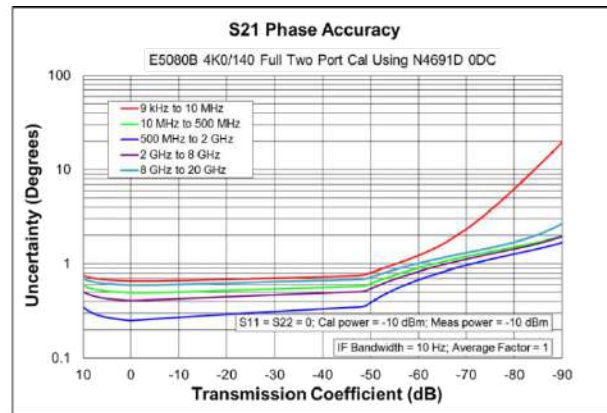
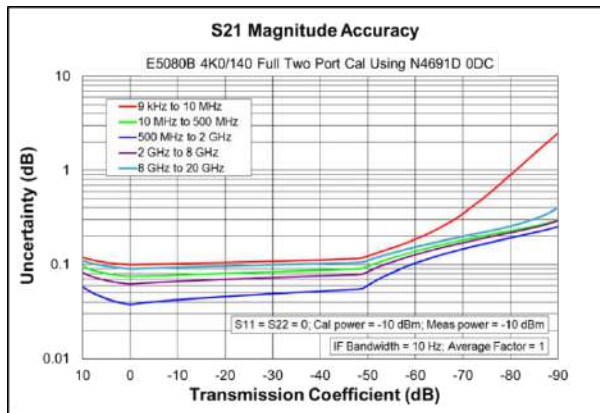

Table 7. Option 240/260/290/2D0/2H0/2K0/440/460/490/4D0/4H0/4K0/442/462/492/4D2/4H2/4K2 with bias tee options (Option 120 or 140) with N4691D Electronic Calibration (ECal) Module with Option 0DC

Corrected Error Terms (dB) – Specifications

Description	9 kHz to 10 MHz	10 MHz to 500 MHz	500 MHz to 2 GHz	2 GHz to 8 GHz	8 GHz to 20 GHz
Directivity	46	46	47	46	43
Source match	41	41	47	45	42
Load match	38	40	46	43	40
Reflection tracking	± 0.05	± 0.05	± 0.002	± 0.03	± 0.04
Transmission tracking	± 0.081	± 0.058	± 0.026	± 0.047	± 0.071

Transmission Uncertainty (magnitude and phase)



Reflection Uncertainty (magnitude and phase)

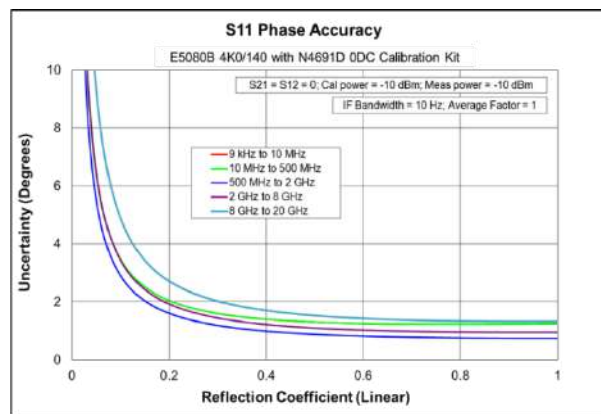
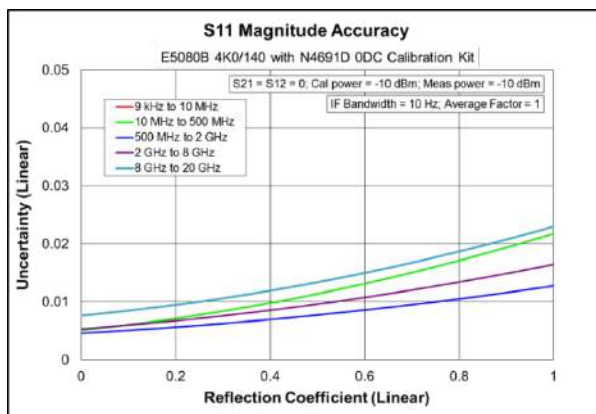
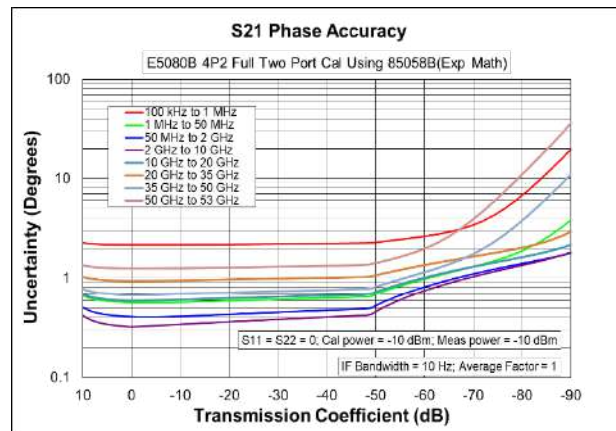
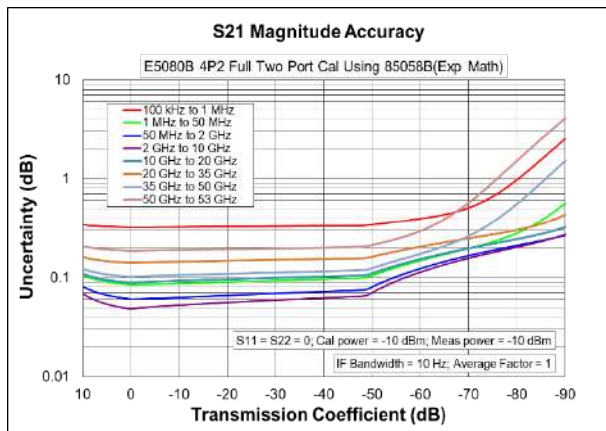

Table 8. Option 2L0/2M0/2N0/2P0/4L0/4M0/4N0/4P0/4L2/4M2/4N2/4P2 with 85058B Standard Mechanical Calibration Kit

Corrected Error Terms (dB) – Specifications

Description	100 kHz to 1 MHz	1 MHz to 50 MHz	50 MHz to 2 GHz	2 GHz to 10 GHz	10 GHz to 20 GHz	20 GHz to 35 GHz	35 GHz to 50 GHz	50 GHz to 53 GHz
Directivity	35	35	35	41	38	37	37	34
Source match	34	34	34	44	40	41	42	40
Load match	34	35	35	41	37	36	36	33
Reflection tracking	± 0.019	± 0.019	± 0.019	± 0.01	± 0.033	± 0.033	± 0.02	± 0.03
Transmission tracking	± 0.302	± 0.065	± 0.046	± 0.033	± 0.073	± 0.122	± 0.079	± 0.154

Transmission Uncertainty (magnitude and phase)



Reflection Uncertainty (magnitude and phase)

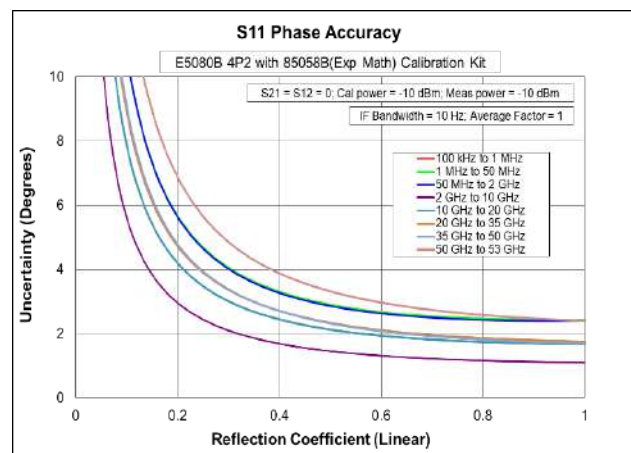
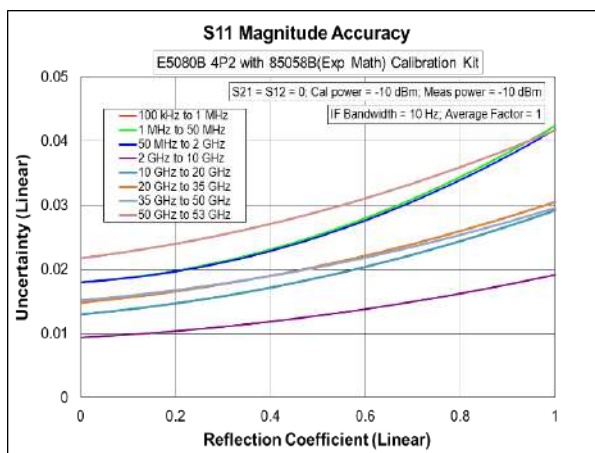
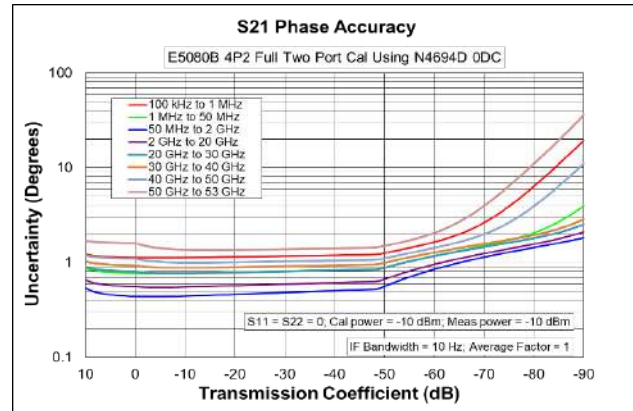
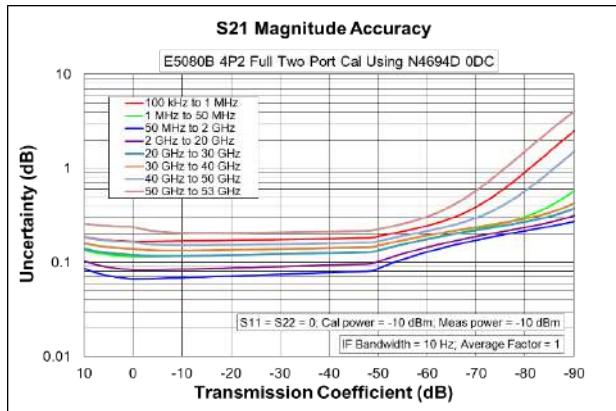

Table 9. Option 2L0/2M0/2N0/2P0/4L0/4M0/4N0/4P0/4L2/4M2/4N2/4P2 with N4694D Electronic Calibration (ECal) Module with Option 0DC

Corrected Error Terms (dB) – Specifications

Description	100 kHz to 1 MHz	1 MHz to 50 MHz	50 MHz to 2 GHz	2 GHz to 20 GHz	20 GHz to 30 GHz	30 GHz to 40 GHz	40 GHz to 50 GHz	50 GHz to 53 GHz
Directivity	41	41	41	42	41	40	38	35
Source match	38	38	38	39	35	34	33	30
Load match	34	37	38	38	34	32	32	29
Reflection tracking	± 0.08	± 0.08	± 0.04	± 0.04	± 0.05	± 0.06	± 0.08	± 0.08
Transmission tracking	± 0.148	± 0.095	± 0.051	± 0.064	± 0.093	± 0.108	± 0.123	± 0.166

Transmission Uncertainty (magnitude and phase)



Reflection Uncertainty (magnitude and phase)

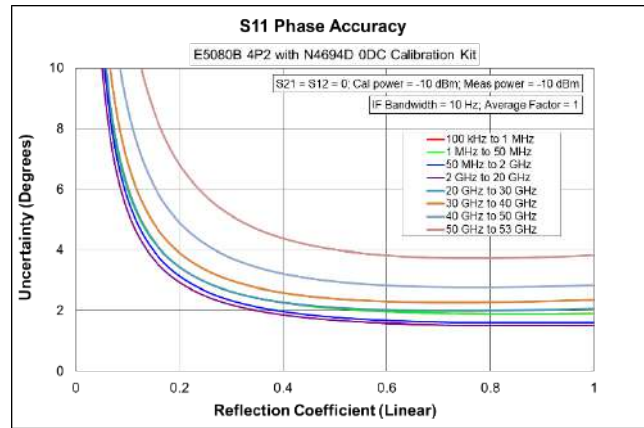
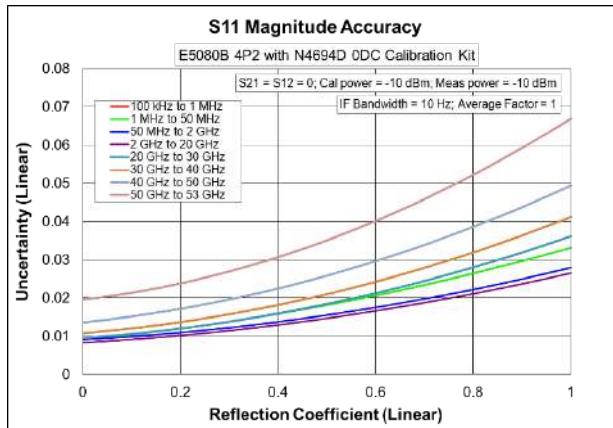

Uncorrected System Performance

Table 10. Uncorrected Error Terms (dB) – Specification¹

Option 240/260/290/2D0/2H0/2K0/440/460/490/4D0/4H0/4K0/442/462/492/4D2/4H2/4K2 (without bias tee options)

Description	Directivity	Source Match	Load Match	Transmission Tracking	Reflection Tracking	Crosstalk
300 kHz to 10 MHz	20	20	15	-	-	-
10 MHz to 1.5 GHz	25	25	17	-	-	-
1.5 GHz to 3 GHz	25	25	16	-	-	-
3 GHz to 6 GHz	25	25	11	-	-	-
6 GHz to 10 GHz	20	20	11	-	-	-
10 GHz to 16 GHz	15	15	11	-	-	-
16 GHz to 20 GHz	15	15	8	-	-	-

Option 2L0/2M0/2N0/2P0/4L0/4M0/4N0/4P0/4L2/4M2/4N2/4P2

Description	Directivity	Source Match	Load Match	Transmission Tracking	Reflection Tracking	Crosstalk
300 kHz to 1 MHz	20	20	1	-	-	-
1 MHz to 3 MHz	20	20	14	-	-	-
3 MHz to 10 MHz	20	20	17	-	-	-
10 MHz to 4 GHz	25	25	17	-	-	-
4 GHz to 6 GHz	25	25	12	-	-	-
6 GHz to 10 GHz	20	20	12	-	-	-
10 GHz to 20 GHz	15	15	9	-	-	-
20 GHz to 27 GHz	15	15	8	-	-	-
27 GHz to 40 GHz	15	15	5	-	-	-
40 GHz to 50 GHz	15	15	8	-	-	-
50 GHz to 53 GHz	10	10	5	-	-	-

Option 240/260/290/2D0/2H0/2K0/440/460/490/4D0/4H0/4K0/442/462/492/4D2/4H2/4K2 with bias tee options (Option 120 or 140)

Description	Directivity	Source Match	Load Match	Transmission Tracking	Reflection Tracking	Crosstalk
300 kHz to 10 MHz	20	20	15	-	-	-
10 MHz to 1.5 GHz	25	25	17	-	-	-
1.5 GHz to 3 GHz	25	25	16	-	-	-
3 GHz to 6 GHz	25	25	10	-	-	-
6 GHz to 10 GHz	20	20	8	-	-	-
10 GHz to 16 GHz	15	15	8	-	-	-
16 GHz to 20 GHz	15	15	6	-	-	-

1. The specifications apply to following conditions: Factory correction is turned on. Cable loss not included in transmission tracking.

Table 11. Uncorrected Error Terms (dB) – Typical

Option 240/260/290/2D0/2H0/2K0/440/460/490/4D0/4H0/4K0/442/462/492/4D2/4H2/4K2 (without bias tee options)

Description	Directivity	Source Match	Load Match	Transmission Tracking	Reflection Tracking	Crosstalk
9 kHz to 30 kHz	40	40	5	± 0.5	± 0.5	-110
30 kHz to 100 kHz	40	40	10	± 0.5	± 0.5	-110
100 kHz to 300 kHz	40	40	18	± 0.2	± 0.2	-120
300 kHz to 3 MHz	40	40	23	± 0.2	± 0.2	-120
3 MHz to 10 MHz	40	40	23	± 0.2	± 0.2	-139
10 MHz to 50 MHz	40	40	23	± 0.2	± 0.2	-147 ¹
50 MHz to 1.5 GHz	40	40	23	± 0.2	± 0.2	-150
1.5 GHz to 3 GHz	40	40	20	± 0.2	± 0.2	-150
3 GHz to 4.5 GHz	40	40	15	± 0.2	± 0.2	-149
4.5 GHz to 6 GHz	40	40	15	± 0.2	± 0.2	-147
6 GHz to 9 GHz	35	35	15	± 0.3	± 0.3	-146
9 GHz to 10 GHz	35	35	15	± 0.3	± 0.3	-142
10 GHz to 13 GHz	35	35	15	± 0.5	± 0.5	-142
13 GHz to 16 GHz	35	35	15	± 0.5	± 0.5	-140
16 GHz to 20 GHz	35	35	12	± 0.5	± 0.5	-137

Option 2L0/2M0/2N0/2P0/4L0/4M0/4N0/4P0/4L2/4M2/4N2/4P2

Description	Directivity	Source Match	Load Match	Transmission Tracking	Reflection Tracking	Crosstalk
100 kHz to 300 kHz	40	40	2	± 0.5	± 0.5	-106
300 kHz to 500 kHz	40	40	2	± 0.5	± 0.5	-120
500 kHz to 1 MHz	40	40	2	± 0.5	± 0.5	-130
1 MHz to 3 MHz	40	40	16	± 0.5	± 0.5	-130
3 MHz to 10 MHz	40	40	20	± 0.5	± 0.5	-138
10 MHz to 50 MHz	40	40	20	± 0.2	± 0.2	-147 ¹
50 MHz to 4 GHz	40	40	20	± 0.2	± 0.2	-150
4 GHz to 6 GHz	40	40	15	± 0.2	± 0.2	-150
6 GHz to 8 GHz	35	35	15	± 0.2	± 0.2	-150
8 GHz to 10 GHz	35	35	15	± 0.2	± 0.2	-147
10 GHz to 16 GHz	35	35	11	± 0.3	± 0.3	-147
16 GHz to 20 GHz	35	35	11	± 0.3	± 0.3	-143
20 GHz to 24 GHz	25	25	10	± 0.3	± 0.3	-143
24 GHz to 26 GHz	25	25	10	± 0.3	± 0.3	-141
26 GHz to 27 GHz	25	25	10	± 0.3	± 0.3	-137
27 GHz to 35 GHz	25	25	7	± 0.3	± 0.3	-137
35 GHz to 40 GHz	25	25	7	± 0.3	± 0.3	-134
40 GHz to 45 GHz	20	20	11	± 0.5	± 0.5	-132
45 GHz to 50 GHz	20	20	11	± 0.5	± 0.5	-115
50 GHz to 53 GHz	15	15	8	± 1	± 1	-101

1. It may typically be degraded at 25 MHz.

Option 240/260/290/2D0/2H0/2K0/440/460/490/4D0/4H0/4K0/442/462/492/4D2/4H2/4K2 with bias tee options (Option 120 or 140)

Description	Directivity	Source Match	Load Match	Transmission Tracking	Reflection Tracking	Crosstalk
9 kHz to 30 kHz	40	40	5	± 0.5	± 0.5	-109
30 kHz to 100 kHz	40	40	10	± 0.5	± 0.5	-109
100 kHz to 3 MHz	40	40	18	± 0.2	± 0.2	-120
3 MHz to 10 MHz	40	40	18	± 0.2	± 0.2	-138
10 MHz to 50 MHz	40	40	23	± 0.2	± 0.2	-146 ¹
50 MHz to 1.5 GHz	40	40	23	± 0.2	± 0.2	-148
1.5 GHz to 3 GHz	40	40	20	± 0.2	± 0.2	-148
3 GHz to 4.5 GHz	40	40	12	± 0.2	± 0.2	-147
4.5 GHz to 6 GHz	40	40	12	± 0.2	± 0.2	-144
6 GHz to 9 GHz	35	35	11	± 0.3	± 0.3	-143
9 GHz to 10 GHz	35	35	11	± 0.3	± 0.3	-139
10 GHz to 13 GHz	35	35	11	± 0.5	± 0.5	-139
13 GHz to 14 GHz	35	35	11	± 0.5	± 0.5	-136
14 GHz to 16 GHz	35	35	11	± 0.5	± 0.5	-136
16 GHz to 20 GHz	35	35	10	± 0.5	± 0.5	-132

1. It may typically be degraded at 25 MHz.

Test Port Output¹

Table 12. Frequency Resolution, Accuracy, Stability

Description	Specification	Typical
Frequency resolution	1 Hz	-
Frequency accuracy	± 7 ppm ± 0.45 ppm (Option 1E5)	-
Frequency stability	-	± 7 ppm ² , ± 0.05 ppm (Option 1E5) ² . ± 3 ppm/year Maximum ³ , ± 0.1 ppm/year Maximum (Option 1E5) ³

1. The specifications do not apply to parallel measurements of multiple devices under test (DUT).
2. 0 to 40 °C. Assumes no variation in time.
3. Assumes no variation in temperature.

Table 13. Maximum Output Port Power (dBm)

Option 240/260/290/2D0/2H0/2K0/440/460/490/4D0/4H0/4K0/442/462/492/4D2/4H2/4K2 (without bias tee options)

Description	Specification	Typical
9 kHz to 100 kHz	0	+2
100 kHz to 10 MHz	+5	+7
10 MHz to 4.5 GHz	+10	+13
4.5 GHz to 6.5 GHz	+10	+12
6.5 GHz to 9 GHz	+9	+12
9 GHz to 16 GHz	+7	+10
16 GHz to 20 GHz	+4	+7

Option 2L0/2M0/2N0/2P0/4L0/4M0/4N0/4P0/4L2/4M2/4N2/4P2

Description	Specification	Typical
100 kHz to 300 kHz	-2	+1
300 kHz to 1 MHz	+7	+10
1 MHz to 17 GHz	+10	+13
17 GHz to 20 GHz	+7	+11
20 GHz to 24 GHz	+5	+11
24 GHz to 30 GHz	+5	+8
30 GHz to 38 GHz	+2	+8
38 GHz to 45 GHz	+2	+5
45 GHz to 50 GHz	-6	-1
50 GHz to 53 GHz	-24	-13

Option 240/260/290/2D0/2H0/2K0/440/460/490/4D0/4H0/4K0/442/462/492/4D2/4H2/4K2 with bias tee options (Option 120 or 140)

Description	Specification	Typical
9 kHz to 100 kHz	-1	+2
100 kHz to 1 MHz	+4.5	+7
1 MHz to 10 MHz	+4.5	+7
10 MHz to 50 MHz	+9.5	+12
50 MHz to 3 GHz	+9	+12
3 GHz to 4.5 GHz	+9	+12
4.5 GHz to 6.5 GHz	+8	+11
6.5 GHz to 9 GHz	+7.5	+11
9 GHz to 14 GHz	+5.5	+9
14 GHz to 16 GHz	+5	+9
16 GHz to 20 GHz	+1.5	+5

Table 14. Power Sweep Range (dBm)¹

Option 240/260/290/2D0/2H0/2K0/440/460/490/4D0/4H0/4K0/442/462/492/4D2/4H2/4K2 (without bias tee options)

Description	Specification	Typical
9 kHz to 100 kHz	-	-60 to +2
100 kHz to 10 MHz	-	-60 to +7
10 MHz to 4.5 GHz	-	-60 to +13
4.5 GHz to 6 GHz	-	-60 to +12
6 GHz to 9 GHz	-	-60 to +12
9 GHz to 16 GHz	-	-60 to +10
16 GHz to 20 GHz	-	-60 to +7

Option 2L0/2M0/2N0/2P0/4L0/4M0/4N0/4P0/4L2/4M2/4N2/4P2

Description	Specification	Typical
100 kHz to 300 kHz	-	-60 to +1
300 kHz to 1 MHz	-	-60 to +10
1 MHz to 17 GHz	-	-60 to +13
17 GHz to 20 GHz	-	-60 to +11
20 GHz to 24 GHz	-	-50 to +11
24 GHz to 38 GHz	-	-50 to +8
38 GHz to 45 GHz	-	-50 to +5
45 GHz to 50 GHz	-	-50 to 0
50 GHz to 53 GHz	-	-50 to -12

1. When set to source power below -50 dBm, spurious related to LO signal may be observed.

Option 240/260/290/2D0/2H0/2K0/440/460/490/4D0/4H0/4K0/442/462/492/4D2/4H2/4K2 with bias tee options (Option 120 or 140)

Description	Specification	Typical
9 kHz to 100 kHz	-	-60 to +2
100 kHz to 10 MHz	-	-60 to +7
10 MHz to 4.5 GHz	-	-60 to +12
4.5 GHz to 9 GHz	-	-60 to +11
9 GHz to 16 GHz	-	-60 to +9
16 GHz to 20 GHz	-	-60 to +5

Table 15. Power Level Accuracy (dB)

Option 240/260/290/2D0/2H0/2K0/440/460/490/4D0/4H0/4K0/442/462/492/4D2/4H2/4K2^{1, 2}

Description	Specification	Typical
9 kHz to 100 kHz	± 4.0	± 1.0
100 kHz to 15 GHz	± 1.5	± 0.2
15 GHz to 20 GHz	± 2.0	± 0.3

1. At nominal power of 0 dBm, stepped sweep mode.
2. At nominal power of -1 dBm, stepped sweep mode with option 120 or 140 for 9 kHz to 100 kHz.

Option 2L0/2M0/2N0/2P0/4L0/4M0/4N0/4P0/4L2/4M2/4N2/4P2¹

Description	Specification	Typical
100 kHz to 10 MHz	± 3.0	± 0.5
10 MHz to 15 GHz	± 1.5	± 0.2
15 GHz to 30 GHz	± 2.0	± 0.2
30 GHz to 40 GHz	± 2.5	± 0.3
40 GHz to 50 GHz	± 2.5	± 0.5
50 GHz to 53 GHz	-	± 1.0

1. At nominal power of -15 dBm, stepped sweep mode.

Table 16. Power Level Linearity (dB)^{1, 2}

Option 240/260/290/2D0/2H0/2K0/440/460/490/4D0/4H0/4K0/442/462/492/4D2/4H2/4K2

Description	Specification ³	Typical ^{3, 4}
9 kHz to 10 GHz	± 0.75	± 1.0
10 GHz to 20 GHz	± 1.0	± 1.0

1. Level linearity given is relative to 0 dBm.
2. Level linearity given is relative to -1 dBm with option 120 or 140 for 9 kHz to 100 kHz.
3. Stepped sweep mode. $-20 \text{ dBm} \leq P \leq \text{maximum specified power}$.
4. Stepped sweep mode. $-60 \text{ dBm} \leq P < -20 \text{ dBm}$.

Option 2L0/2M0/2N0/2P0/4L0/4M0/4N0/4P0/4L2/4M2/4N2/4P2¹

Description	Specification ²	Typical
100 kHz to 10 GHz	± 0.75	± 1.0 ^{3, 5}
10 GHz to 20 GHz	± 1.0	± 1.0 ^{3, 5}
20 GHz to 50 GHz	± 2.0	± 1.0 ^{4, 6}

1. Level linearity given is relative to -15 dBm.
2. Stepped sweep mode. $-20 \text{ dBm} \leq P \leq$ maximum specified power.
3. Swept sweep mode. $-60 \text{ dBm} \leq P \leq$ maximum specified power.
4. Swept sweep mode. $-65 \text{ dBm} \leq P \leq$ maximum specified power.
5. Stepped sweep mode. $-60 \text{ dBm} \leq P < -20 \text{ dBm}$.
6. Stepped sweep mode. $-50 \text{ dBm} \leq P < -20 \text{ dBm}$.

Table 17. 2nd and 3rd Harmonics (dBc)

Option 240/260/290/2D0/2H0/2K0/440/460/490/4D0/4H0/4K0/442/462/492/4D2/4H2/4K2¹

Description	Specification	Typical
30 kHz to 10 MHz	-	-20
10 MHz to 20 GHz	-	-25

Option 2L0/2M0/2N0/2P0/4L0/4M0/4N0/4P0/4L2/4M2/4N2/4P2^{1, 2}

Description	Specification	Typical
300 kHz to 1 MHz	-	-20
1 MHz to 20 GHz	-	-25
20 GHz to 25 GHz	-	-17
25 GHz to 40 GHz	-	-20
40 GHz to 47 GHz	-	-15
47 GHz to 53 GHz	-	-17

1. Listed frequency is harmonic frequency. Tested at power of 0 dBm.
2. Listed frequency is harmonic frequency. Tested at power of -2dBm at 100 kHz to 200 kHz.

Table 18. Sub-harmonic (dBc)

Option 240/260/290/2D0/2H0/2K0/440/460/490/4D0/4H0/4K0/442/462/492/4D2/4H2/4K2¹

Description	Specification	Typical
9 kHz to 10 MHz	-	-50
10 MHz to 20 GHz	-	-35

1. Listed frequency is fundamental frequency. Tested at power of 0 dBm.

Option 2L0/2M0/2N0/2P0/4L0/4M0/4N0/4P0/4L2/4M2/4N2/4P2²

Description	Specification	Typical
100 kHz to 10 GHz	-	-50
10 GHz to 20 GHz	-	-35
20 GHz to 40 GHz	-	-30
40 GHz to 47 GHz	-	-20
47 GHz to 50 GHz	-	-10
50 GHz to 53 GHz	-	-2

2. Listed frequency is fundamental frequency. Tested at power of -15 dBm.

Table 19. Non-harmonic Spurs at Nominal Power (dBc)

Option 240/260/290/2D0/2H0/2K0/440/460/490/4D0/4H0/4K0/442/462/492/4D2/4H2/4K2¹

Description	Specification	Typical
9 kHz to 10 GHz	-	-50
10 GHz to 20 GHz		-45

1. Listed frequency is fundamental frequency. Includes spurious related to LO signal and frac-N.

Option 2L0/2M0/2N0/2P0/4L0/4M0/4N0/4P0/4L2/4M2/4N2/4P2²

Description	Specification	Typical
100 kHz to 10 GHz	-	-50
10 GHz to 20 GHz	-	-45
20 GHz to 53 GHz	-	-35

2. Listed frequency is fundamental frequency. Includes spurious related to LO signal and frac-N.

Table 20. Nominal Power (Preset Power Level)

Description	Specification
Option 240/260/290/2D0/2H0/2K0/ 440/460/490/4D0/4H0/4K0/442/462/492/4D2/4H2/4K2	0 dBm
Option 2L0/2M0/2N0/2P0/4L0/4M0/4N0/4P0/4L2/4M2/4N2/4P2	-15 dBm

Table 21. Power Resolution, Maximum/minimum Settable Power

Description	Specification	Typical
Settable resolution	-	0.01 dB
Maximum settable power	-	+20 dBm
Minimum settable power	-	-100 dBm

Test Port Input

Table 22. Test Port Noise Floor (dBm)¹

Option 240/260/290/2D0/2H0/2K0/440/460/490/4D0/4H0/4K0/442/462/492/4D2/4H2/4K2 (without bias tee options)

Description	Specification	Typical
9 kHz to 100 kHz	-101	-109
100 kHz to 300 kHz	-112	-119
300 kHz to 1 MHz	-120	-127
1 MHz to 10 MHz	-125	-132
10 MHz to 50 MHz ²	-127	-134
50 MHz to 3 GHz	-130	-137
3 GHz to 4.5 GHz	-130	-136
4.5 GHz to 6.5 GHz	-130	-135
6.5 GHz to 9 GHz	-127	-134
9 GHz to 14 GHz	-126	-132
14 GHz to 16 GHz	-123	-130
16 GHz to 20 GHz	-122	-130

Option 2L0/2M0/2N0/2P0/4L0/4M0/4N0/4P0/4L2/4M2/4N2/4P2

Description	Specification	Typical
100 kHz to 300 kHz	-97	-105
300 kHz to 500 kHz	-97	-110
500 kHz to 1 MHz	-110	-120
1 MHz to 10 MHz	-115	-124
10 MHz to 50 MHz ²	-127	-133
50 MHz to 200 MHz	-130	-133
200 MHz to 3 GHz	-130	-137
3 GHz to 6.5 GHz	-130	-135
6.5 GHz to 9 GHz	-128	-134
9 GHz to 17 GHz	-127	-133
17 GHz to 25 GHz	-125	-131
25 GHz to 30 GHz	-122	-129
30 GHz to 45 GHz	-120	-127
45 GHz to 50 GHz	-105	-115
50 GHz to 53 GHz	-95	-113

1. Noise floor in a 10 Hz IF Bandwidth. Measured with 1 kHz IF bandwidth for 9 kHz to < 100 kHz, and 30 kHz IF bandwidth for 100 kHz to 20 GHz. Test port terminated.

Option 240/260/290/2D0/2H0/2K0/440/460/490/4D0/4H0/4K0/442/462/492/4D2/4H2/4K2 with bias tee options (Option 120 or 140)

Description	Specification	Typical
9 kHz to 100 kHz	-100	-108
100 kHz to 300 kHz	-112	-119
300 kHz to 1 MHz	-120	-127
1 MHz to 10 MHz	-125	-132
10 MHz to 50 MHz ²	-127	-134
50 MHz to 2 GHz	-129	-137
2 GHz to 3 GHz	-129	-136
3 GHz to 4.5 GHz	-129	-135
4.5 GHz to 6 GHz	-127	-134
6 GHz to 6.5 GHz	-127	-133
6.5 GHz to 9 GHz	-126	-133
9 GHz to 14 GHz	-125	-131
14 GHz to 16 GHz	-121	-128
16 GHz to 20 GHz	-120	-128

2. It may typically be degraded at 25 MHz.

Table 23. Receiver Compression at Test Port

Option 240/260/290/2D0/2H0/2K0/440/460/490/4D0/4H0/4K0/442/462/492/4D2/4H2/4K2 (without bias tee options)

Description	Input power at test port (dBm)	Specification		Typical	
		Magnitude (dB)	Phase (°)	Magnitude (dB)	Phase (°)
9 kHz to 100 kHz	0	0.5	5	0.10	1.5
100 kHz to 10 MHz	+5	0.2	5	0.05	1.0
10 MHz to 6.5 GHz	+10	0.2	5	0.05	1.0
6.5 GHz to 9 GHz	+9	0.2	5	0.05	1.0
9 GHz to 16 GHz	+7	0.2	5	0.05	1.0
16 GHz to 20 GHz	+4	0.2	5	0.05	1.0

Option 2L0/2M0/2N0/2P0/4L0/4M0/4N0/4P0/4L2/4M2/4N2/4P2

Description	Input power at test port (dBm)	Specification		Typical	
		Magnitude (dB)	Phase (°)	Magnitude (dB)	Phase (°)
100 kHz to 300 kHz	-2	0.2	5	0.10	1.0
300 kHz to 1 MHz	+7	0.2	5	0.10	1.0
1 MHz to 17 GHz	+10	0.2	5	0.05	1.0
17 GHz to 20 GHz	+7	0.2	5	0.05	1.0
20 GHz to 30 GHz	+5	0.2	5	0.05	1.0
30 GHz to 45 GHz	+2	0.2	5	0.05	1.0
45 GHz to 50 GHz	-6	0.2	5	0.05	1.0
50 GHz to 53 GHz	-24	0.2	5	0.05	1.0

Option 240/260/290/2D0/2H0/2K0/440/460/490/4D0/4H0/4K0/442/462/492/4D2/4H2/4K2 with bias tee options (Option 120 or 140)

Description	Input power at test port/ (dBm)	Specification		Typical	
		Magnitude (dB)	Phase (°)	Magnitude (dB)	Phase (°)
9 kHz to 100 kHz	-1	0.5	5	0.10	1.5
100 kHz to 10 MHz	+4.5	0.2	5	0.05	1.0
10 MHz to 50 MHz	+9.5	0.2	5	0.05	1.0
50 MHz to 4.5 GHz	+9	0.2	5	0.05	1.0
4.5 GHz to 6.5 GHz	+8	0.2	5	0.05	1.0
6.5 GHz to 9 GHz	+7.5	0.2	5	0.05	1.0
9 GHz to 14 GHz	+5.5	0.2	5	0.05	1.0
14 GHz to 16 GHz	+5	0.2	5	0.05	1.0
16 GHz to 20 GHz	+1.5	0.2	5	0.05	1.0

Table 24. Trace Noise Magnitude (dB rms)¹

Option 240/260/290/2D0/2H0/2K0/440/460/490/4D0/4H0/4K0/442/462/492/4D2/4H2/4K2 (without bias tee options)

Description	Specification ²	Typical ²
9 kHz to 30 kHz	0.005	0.0025
30 kHz to 100 kHz	0.003	0.001
100 kHz to 6 GHz ⁴	0.0015	0.0005
6 GHz to 10 GHz	0.002	0.0006
10 GHz to 20 GHz	0.003	0.001

Option 2L0/2M0/2N0/2P0/4L0/4M0/4N0/4P0/4L2/4M2/4N2/4P2

Description	Specification	Typical
100 kHz to 300 kHz	0.005	0.002
300 kHz to 1 MHz	0.003	0.001
1 MHz to 4.5 GHz ²	0.0015	0.0005
4.5 GHz to 10 GHz	0.0015	0.0007
10 GHz to 17 GHz	0.002	0.001
17 GHz to 30 GHz	0.003	0.0013
30 GHz to 45 GHz	0.006	0.0022
45 GHz to 50 GHz	0.018	0.006

Option 240/260/290/2D0/2H0/2K0/440/460/490/4D0/4H0/4K0/442/462/492/4D2/4H2/4K2 with bias tee options (Option 120 or 140)

Description	Specification ²	Typical ³
9 kHz to 30 kHz	0.006	0.003
30 kHz to 100 kHz	0.003	0.001
100 kHz to 10 MHz	0.0015	0.0005
10 MHz to 6 GHz ⁴	0.002	0.0005
6 GHz to 10 GHz	0.003	0.0006
10 GHz to 16 GHz	0.0035	0.001
16 GHz to 20 GHz	0.004	0.001

1. Transmission and reflection trace noise in a 1 kHz IF bandwidth for < 10 MHz, 10 kHz IF bandwidth ≥ 10 MHz.
2. At maximum specified power (Table 13).
3. At typical maximum power (Table 13).
4. It may typically be degraded at particular frequencies such as 25 MHz, 54 MHz, 58.5 MHz, 156 MHz, 108 MHz, 120 MHz or 132 MHz.

Table 25. Trace Noise Phase (degree rms)¹

Option 240/260/290/2D0/2H0/2K0/440/460/490/4D0/4H0/4K0/442/462/492/4D2/4H2/4K2 (without bias tee options)

Description	Specification ²	Typical ²
9 kHz to 30 kHz	0.07	0.025
30 kHz to 100 kHz	0.05	0.017
100 kHz to 300 kHz	0.035	0.006
300 kHz to 6 GHz ⁴	0.01	0.003
6 GHz to 10 GHz	0.02	0.006
10 GHz to 13.5 GHz	0.03	0.006
13.5 GHz to 20 GHz	0.03	0.01

Option 2L0/2M0/2N0/2P0/4L0/4M0/4N0/4P0/4L2/4M2/4N2/4P2

Description	Specification	Typical
100 kHz to 300 kHz	0.07	0.015
300 kHz to 1 MHz	0.03	0.01
1 MHz to 6 GHz ²	0.02	0.003
6 GHz to 10 GHz	0.02	0.004
10 GHz to 17 GHz	0.02	0.006
17 GHz to 30 GHz	0.02	0.01
30 GHz to 45 GHz	0.04 (0.046 ⁵)	0.027
45 GHz to 50 GHz	0.18	0.03

Option 240/260/290/2D0/2H0/2K0/440/460/490/4D0/4H0/4K0/442/462/492/4D2/4H2/4K2 with bias tee options (Option 120 or 140)

Description	Specification ²	Typical ³
9 kHz to 30 kHz	0.08	0.03
30 kHz to 100 kHz	0.05	0.017
100 kHz to 300 kHz	0.035	0.006
300 kHz to 10 MHz	0.01	0.003
10 MHz to 6 GHz ⁴	0.015	0.003
6 GHz to 10 GHz	0.025	0.006
10 GHz to 13.5 GHz	0.03	0.006
13.5 GHz to 16 GHz	0.03	0.01
16 GHz to 20 GHz	0.035	0.01

1. Transmission and reflection trace noise in a 1 kHz IF bandwidth for < 10 MHz, 10 kHz IF bandwidth ≥ 10 MHz.
2. At maximum specified power (Table 11).
3. At typical maximum power (Table 11).
4. It may typically be degraded at particular frequencies such as 25 MHz, 54 MHz, 58.5 MHz, 156 MHz, 108 MHz, 120 MHz or 132 MHz.
5. Only in the reflection measurement.

Table 26. Temperature Stability – Typical

Option 240/260/290/2D0/2H0/2K0/440/460/490/4D0/4H0/4K0/442/462/492/4D2/4H2/4K2

Description	Magnitude (dB/°C)	Phase (degree/°C)
9 kHz to 300 kHz	0.03	0.2
300 kHz to 4.5 GHz	0.005	0.1
4.5 GHz to 6 GHz	0.01	0.1
6 GHz to 6.5 GHz	0.01	0.2
6.5 GHz to 10 GHz	0.015	0.2
10 GHz to 14 GHz	0.015	0.3
14 GHz to 20 GHz	0.02	0.4

Option 2L0/2M0/2N0/2P0/4L0/4M0/4N0/4P0/4L2/4M2/4N2/4P2

Description	Magnitude (dB/°C)	Phase (degree/°C)
100 kHz to 1 MHz	0.03	1.0
1 MHz to 10 MHz	0.005	0.2
10 MHz to 4.5 GHz	0.005	0.1
4.5 GHz to 10 GHz	0.01	0.1
10 GHz to 20 GHz	0.01	0.2
20 GHz to 30 GHz	0.01	0.25
30 GHz to 40 GHz	0.01	0.3
40 GHz to 50 GHz	0.03	0.8
50 GHz to 53 GHz	0.06	1.0

Table 27. Damage Input Level

Description	Description
Damage Input Level	+27 dBm or \pm 35 VDC (Warranted)

Dynamic Accuracy

Accuracy of the test port input power relative to the reference input power level. Measured with 10 Hz IF bandwidth.

Dynamic Accuracy¹ – Specification

Option 240/260/290/2D0/2H0/2K0/440/460/490/4D0/4H0/4K0/442/462/492/4D2/4H2/4K2

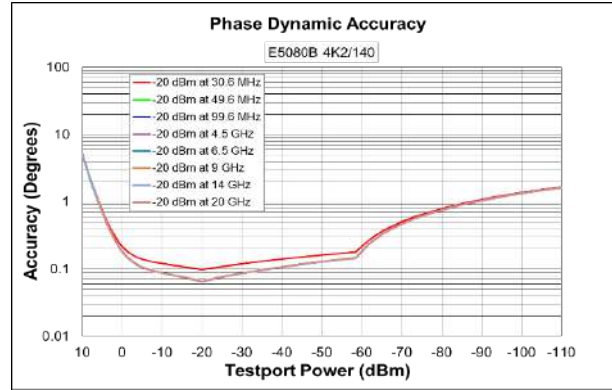
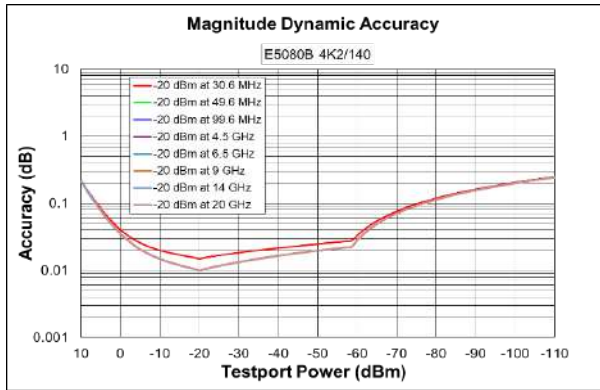

Option 2L0/2M0/2N0/2P0/4L0/4M0/4N0/4P0/4L2/4M2/4N2/4P2

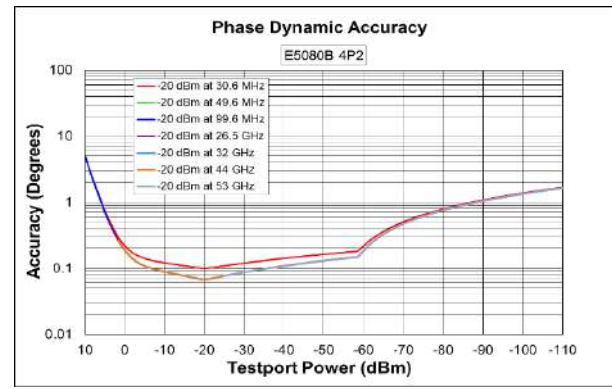
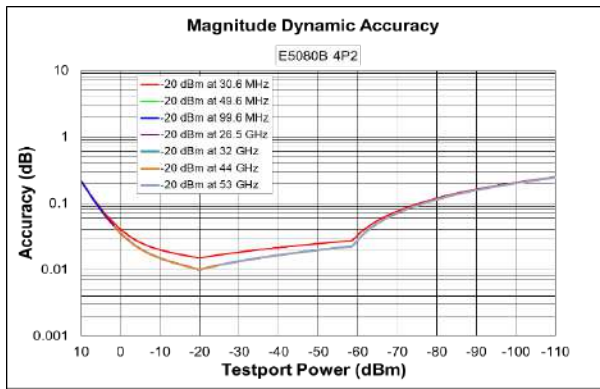

1. Dynamic accuracy is verified with the following measurements:
 - Compression over frequency
 - IF linearity using a reference level of -20 dBm for an input power range of 0 to -60 dBm. Tested at three single frequencies (30.6 MHz, 49.6 MHz and 99.6 MHz) to cover the whole frequency range. The VNA receiver is linear by design when signal levels are below -60 dBm. For more details, refer to [VNA Receiver Dynamic Accuracy Specifications and Uncertainties](#).
2. Download Uncertainty Calculator from http://www.keysight.com/find/na_calculator to generate the curves of dynamic accuracy.

Spectrum Analysis (with Option 09x and S96090B/A)

This section provides specifications for the spectrum analysis hardware (Option 090 to 098) on the E5080B ENA Series VNA. The S96090B/A Software is required to enable spectrum analysis functions.

Table 28. Frequency Specifications

Description	Specification	Supplemental Information
Frequency Reference¹		
Accuracy	-	± [(time since last adjustment x aging rate) + temperature stability + calibration accuracy], typical
Aging Rate	-	± 3 ppm/year maximum, typical ± 0.1 ppm/year maximum, typical (Option 1E5)
Temperature Stability	-	± 7 ppm (0 to 40 °C) ± 0.45 ppm (0 to 40 °C) (Option 1E5)
Achievable Initial Calibration Accuracy	± 7 ppm ± 0.45 ppm (Option 1E5)	-
Frequency Readout Accuracy (Start, Stop, Center, Marker)	-	± [(readout frequency x frequency reference accuracy) + (<1% x RBW)], nominal
Frequency Span		
Minimum/Maximum	Analyzer's full span	-
Resolution	1 Hz	-
Sweep (Trace) Point Range	11 to 100,001	-
Resolution Bandwidth (RBW)		
Range (-3 dB Bandwidth)	10 Hz to 3 MHz in 10% steps	-
Bandwidth Range Accuracy	-	± 1%, all RBW, except below 100 MHz with 3 MHz RBW
Selectivity (-60 dB/-3 dB)	-	Gaussian: 4.5:1, Flat top: 2.47:1, Kaiser: 3.82:1, Blackman: 3.58:1
Video Bandwidth (VBW)		
Range	10 Hz to 3 MHz	-

1. Frequency reference accuracy can be improved by using external frequency reference with better accuracy.

Table 29. Time Specifications

Description	Specification	Supplemental Information
Sweep Time and Triggering (All Options)		
Sweep Time Range	Auto	
Trigger Types	Continuous, Single, Group, Manual, External	
Trigger Delay Range	0 to 3 s	
Trigger Delay Resolution	1 us	
Measuring and Display Update Rate (milliseconds)¹		
20 MHz Span, 3 kHz RBW, 3 kHz VBW	-	61
100 MHz Span, Auto RBW, Auto VBW	-	61
1 GHz Span, 3 kHz RBW, 3 kHz VBW	-	266
1 GHz Span, 300 kHz RBW, 300 kHz VBW	-	61
10 GHz Span, 3 kHz RBW, 3 kHz VBW	-	2462
10 GHz Span, 300 kHz RBW, 300 kHz VBW	-	432
10 MHz to 20 GHz, RBW/VBW = 1 MHz	-	811
10 MHz to 50 GHz, RBW/VBW = 1 MHz	-	1998

1. Measured with a 2-port option with firmware revision A.14.10.03.

Table 30. Amplitude Accuracy and Range Specifications

Description	Specification
Amplitude Range	
Measurement Range	DANL to maximum input level
Input Attenuator Range	High attenuation or Low attenuation
Maximum Safe Input Level	+27 dBm
Display Range	
Log Scale	0.001 to 500 dB/div in 0.001 steps
Linear Scale	10 divisions (default)
Scale Units	dBm, mW
Trace Detectors Types	Average, Sample, Peak, Normal, Negative Peak, Peak sample, Peak average

Table 31. SA Detector Accuracy (dB)¹ – Specifications

Option 240/260/290/2D0/2H0/2K0/440/460/490/4D0/4H0/4K0/442/462/492/4D2/4H2/4K2

Description	Specification
9 kHz to 10 MHz	± 0.15
10 MHz to 20 GHz	± 0.1

1. With high attention. SA detector accuracy is residual error of IF response calibration. IF response is characterized with E5080B's standard measurement class after power and S-parameter calibration. Therefore, the SA total absolute amplitude accuracy includes power meter, S-parameter and SA detector accuracies. Add input attenuation switching uncertainty if receiver attenuator is changed after user calibration.

Option 2L0/2M0/2N0/2P0/4L0/4M0/4N0/4P0/4L2/4M2/4N2/4P2

Description	Specification (dB)
100 kHz to 10 MHz	± 0.15
10 MHz to 20 GHz	± 0.1
20 GHz to 53 GHz	± 0.15

Table 32. Input Attenuation Switching Uncertainty (dB) – Supplemental Information

Option 240/260/290/2D0/2H0/2K0/440/460/490/4D0/4H0/4K0/442/462/492/4D2/4H2/4K2

Description	Supplemental Information
9 kHz to 50 MHz	± 0.5
50 MHz to 20 GHz	± 1.0

Option 2L0/2M0/2N0/2P0/4L0/4M0/4N0/4P0/4L2/4M2/4N2/4P2

Description	Supplemental Information
100 kHz to 50 MHz	± 0.5
50 MHz to 53 GHz	± 1.0

Table 33. Input VSWR¹ – Specifications

Option 240/260/290/2D0/2H0/2K0/440/460/490/4D0/4H0/4K0/442/462/492/4D2/4H2/4K2 (without bias tee options)

Description	Specification
300 kHz to 10 MHz	1.433
10 MHz to 1.5 GHz	1.329
1.5 GHz to 3 GHz	1.377
3 GHz to 10 GHz	1.785
10 GHz to 16 GHz	1.785
16 GHz to 20 GHz	2.323

1. Calculated by load match of uncorrected error terms (Table 10). $VSWR = \frac{1+10^{(-1 \cdot \text{load match}/20)}}{1-10^{(-1 \cdot \text{load match}/20)}}$

Option 2L0/2M0/2N0/2P0/4L0/4M0/4N0/4P0/4L2/4M2/4N2/4P2

Description	Specification
1 MHz to 3 MHz	1.499
3 MHz to 4 GHz	1.329
4 GHz to 10 GHz	1.671
10 GHz to 20 GHz	2.100
20 GHz to 27 GHz	2.323
27 GHz to 40 GHz	3.570
40 GHz to 50 GHz	2.323
50 GHz to 53 GHz	3.570

Option 240/260/290/2D0/2H0/2K0/440/460/490/4D0/4H0/4K0/442/462/492/4D2/4H2/4K2 with bias tee options (Option 120 or 140)

Description	Specification
300 kHz to 10 MHz	1.433
10 MHz to 1.5 GHz	1.329
1.5 GHz to 3 GHz	1.377
3 GHz to 6 GHz	1.925
6 GHz to 16 GHz	2.323
16 GHz to 20 GHz	3.010

Table 34. Other Amplitude Accuracy – Supplemental Information

Description	Supplemental Information
RBW Switching Uncertainty	0.02 dB
Display Scale Fidelity	See dynamic accuracy specification. Specification applied to SA measurement class with user calibration between -10 dBm and -40 dBm input power and measurement between +10 dBm and -120 dBm input power.

Table 35. Spurious Response – Supplemental Information

Description	Supplemental Information
Image Response	Mostly eliminated. Intermittent image response may be seen when making multi-tone or modulated signal measurements.
LO Related Spurious	Eliminated

Table 36. Displayed Average Noise Level (DANL) at Test Ports with Low Attenuation (dBm/Hz)¹ – Specifications

Option 240/260/290/2D0/2H0/2K0/440/460/490/4D0/4H0/4K0/442/462/492/4D2/4H2/4K2 (without bias tee options)

Description	Specification	Typical
9 kHz to 100 kHz	-114	-122
100 kHz to 1 MHz	-125	-132
1 MHz to 10 MHz	-138	-145
10 MHz to 100 MHz	-140	-147
100 MHz to 4.5 GHz	-144	-150
4.5 GHz to 6.5 GHz	-142	-149
6.5 GHz to 9 GHz	-141	-148
9 GHz to 14 GHz	-140	-146
14 GHz to 16 GHz	-137	-144
16 GHz to 20 GHz	-136	-144

Option 2L0/2M0/2N0/2P0/4L0/4M0/4N0/4P0/4L2/4M2/4N2/4P2

Description	Specification	Typical
100 kHz to 300 kHz	-110	-118
300 kHz to 500 kHz	-110	-120
500 kHz to 1 MHz ²	-123	-130
1 MHz to 10 MHz	-128	-134
10 MHz to 100 MHz	-136	-142
100 MHz to 200 MHz	-144	-146
200 MHz to 3 GHz	-144	-150
3 GHz to 6.5 GHz	-144	-148
6.5 GHz to 9 GHz	-142	-147
9 GHz to 17 GHz	-141	-146
17 GHz to 20 GHz	-139	-146
20 GHz to 25 GHz	-139	-143
25 GHz to 30 GHz	-136	-143
30 GHz to 45 GHz	-134	-141
45 GHz to 50 GHz	-119	-129
50 GHz to 53 GHz	-109	-127

1. Tested with 1 kHz RBW up to 50 MHz and 10 kHz RBW for above 50 MHz, test port terminated, average detector, averaging type = Log, IF gain = Auto, image rejection = normal, random LO OFF.
2. A residual spurious response may be observed around 600 kHz.

Option 240/260/290/2D0/2H0/2K0/440/460/490/4D0/4H0/4K0/442/462/492/4D2/4H2/4K2 with bias tee options (Option 120 or 140)

Description	Specification	Typical
9 kHz to 100 kHz	-113	-121
100 kHz to 300 kHz	-125	-132
300 kHz to 1 MHz	-125	-138
1 MHz to 10 MHz	-138	-145
10 MHz to 100 MHz	-140	-147
100 MHz to 4.5 GHz	-144	-149
4.5 GHz to 6.5 GHz	-141	-148
6.5 GHz to 9 GHz	-140	-147
9 GHz to 14 GHz	-139	-145
14 GHz to 16 GHz	-135	-142
16 GHz to 20 GHz	-134	-142

Table 37. Displayed Average Noise Level (DANL) at Test Ports with High Attenuation (dBm/Hz)¹ – Typical

Option 240/260/290/2D0/2H0/2K0/440/460/490/4D0/4H0/4K0/442/462/492/4D2/4H2/4K2 (without bias tee options)

Description	Specification	Typical
9 kHz to 100 kHz	-	-100
100 kHz to 300 kHz	-	-110
300 kHz to 1 MHz		-116
1 MHz to 10 MHz	-	-116
10 MHz to 100 MHz	-	-116
100 MHz to 4.5 GHz	-	-127
4.5 GHz to 6.5 GHz	-	-127
6.5 GHz to 9 GHz	-	-126
9 GHz to 14 GHz	-	-124
14 GHz to 16 GHz	-	-122
16 GHz to 20 GHz	-	-122

1. Tested with 1 kHz RBW up to 50 MHz and 10 kHz RBW for above 50 MHz, test port terminated, average detector, averaging type = Log, IF gain = Auto, image rejection = normal, random LO OFF.

Option 2L0/2M0/2N0/2P0/4L0/4M0/4N0/4P0/4L2/4M2/4N2/4P2

Description	Specification	Typical
100 kHz to 300 kHz	-	-96
300 kHz to 500 kHz	-	-98
500 kHz to 1 MHz ²	-	-108
1 MHz to 10 MHz	-	-112
10 MHz to 100 MHz	-	-112
100 MHz to 200 MHz	-	-124
200 MHz to 3 GHz	-	-128
3 GHz to 6.5 GHz	-	-126
6.5 GHz to 9 GHz	-	-125
9 GHz to 20 GHz	-	-124
20 GHz to 30 GHz	-	-121
30 GHz to 45 GHz	-	-119
45 GHz to 50 GHz	-	-107
50 GHz to 53 GHz	-	-105

Option 240/260/290/2D0/2H0/2K0/440/460/490/4D0/4H0/4K0/442/462/492/4D2/4H2/4K2 with bias tee options (Option 120 or 140)

Description	Specification	Typical
9 kHz to 100 kHz	-	-99
100 kHz to 300 kHz	-	-110
300 kHz to 1 MHz	-	-116
1 MHz to 10 MHz	-	-116
10 MHz to 100 MHz	-	-116
100 MHz to 4.5 GHz	-	-126
4.5 GHz to 6.5 GHz	-	-126
6.5 GHz to 9 GHz	-	-125
9 GHz to 14 GHz	-	-123
14 GHz to 16 GHz	-	-120
16 GHz to 20 GHz	-	-120

2. A residual spurious response may be observed around 600 kHz.

Table 38. Second Harmonic Distortion with High Attenuation¹ – Supplemental Information

Option 240/260/290/2D0/2H0/2K0/440/460/490/4D0/4H0/4K0/442/462/492/4D2/4H2/4K2

Description	SHI (dBm)
50 MHz to 1 GHz	+30
1 GHz to 4 GHz	+38
4 GHz to 10 GHz	+47

Option 2L0/2M0/2N0/2P0/4L0/4M0/4N0/4P0/4L2/4M2/4N2/4P2

Description	SHI (dBm)
50 MHz to 1 GHz	+30
1 GHz to 4 GHz	+38
4 GHz to 10 GHz	+47
10 GHz 15 GHz	+44
15 GHz to 26.5 GHz	+40

1. Tested with 0 dBm for 50 MHz to 10 GHz, and -5 dBm for 10 GHz to 26.5 GHz input at test port, 10 MHz tone separations.

Table 39. Second Harmonic Distortion with Low Attenuation¹ – Supplemental Information

Option 240/260/290/2D0/2H0/2K0/440/460/490/4D0/4H0/4K0/442/462/492/4D2/4H2/4K2

Description	SHI (dBm)
50 MHz to 1 GHz	+10
1 GHz to 4 GHz	+20
4 GHz to 10 GHz	+30

Option 2L0/2M0/2N0/2P0/4L0/4M0/4N0/4P0/4L2/4M2/4N2/4P2

Description	SHI (dBm)
50 MHz to 1 GHz	+10
1 GHz to 4 GHz	+20
4 GHz to 10 GHz	+30
10 GHz 15 GHz	+26
15 GHz to 20 GHz	+21
20 GHz to 26.5 GHz	+16

1. Tested with -25 dBm input at test port, 10 MHz tone separations.

Table 40. Third Order Intermodulation Distortion with High Attenuation¹ – Characteristic

Option 240/260/290/2D0/2H0/2K0/440/460/490/4D0/4H0/4K0/442/462/492/4D2/4H2/4K2

Description	Distortion (dBc)	TOI (dBm)
50 MHz to 200 MHz	-40	+20
200 MHz to 2 GHz	-44	+22
2 GHz to 5 GHz	-46	+23
5 GHz to 10 GHz	-50	+25
10 GHz to 15 GHz	-60	+25
15 GHz to 20 GHz	-54	+22

Option 2L0/2M0/2N0/2P0/4L0/4M0/4N0/4P0/4L2/4M2/4N2/4P2

Description	Distortion (dBc)	TOI (dBm)
50 MHz to 200 MHz	-40	+20
200 MHz to 2 GHz	-44	+22
2 GHz to 5 GHz	-46	+23
5 GHz to 10 GHz	-50	+25
10 GHz to 15 GHz	-56	+23
15 GHz to 20 GHz	-52	+21
20 GHz to 30 GHz	-42	+16
30 GHz to 40 GHz	-48	+14
40 GHz to 53 GHz	-52	+11

1. Tested with 0 dBm for 50 MHz to 10 GHz, -5 dBm for 10 GHz to 30 GHz, -10 dBm for 30 GHz to 40 GHz, and -15 dBm for 40 GHz to 53 GHz input at test port, 10 MHz tone separations.

Table 41. Third Order Intermodulation Distortion with Low Attenuation¹ – Characteristic

Option 240/260/290/2D0/2H0/2K0/440/460/490/4D0/4H0/4K0/442/462/492/4D2/4H2/4K2

Description	Distortion (dBc)	TOI (dBm)
50 MHz to 5 GHz	-56	+3
5 GHz to 10 GHz	-52	+1
10 GHz to 20 GHz	-66	+8

Option 2L0/2M0/2N0/2P0/4L0/4M0/4N0/4P0/4L2/4M2/4N2/4P2

Description	Distortion (dBc)	TOI (dBm)
50 MHz to 5 GHz	-56	+3
5 GHz to 10 GHz	-52	+1
10 GHz to 20 GHz	-66	+7
20 GHz to 30 GHz	-66	+5
30 GHz to 53 GHz	-66	+2

1. Tested with -25 dBm input at test port, 10 MHz tone separations.

DANL and Distortion Relative to Test Port Level (dB)¹ – Nominal

Option 240/260/290/2D0/2H0/2K0/440/460/490/4D0/4H0/4K0/442/462/492/4D2/4H2/4K2

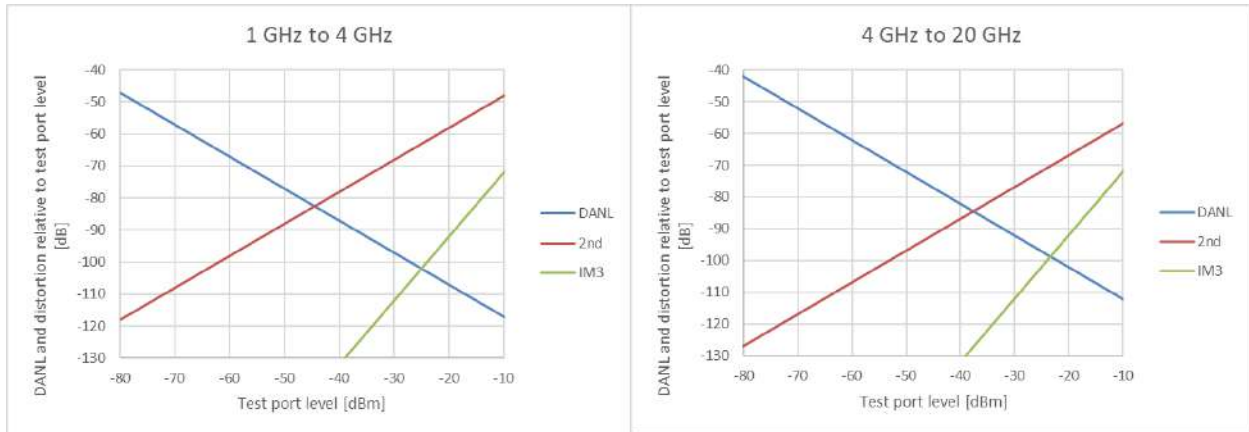

1. With High Attenuation. 2nd harmonic distortion applies up to 10 GHz.

Option 2L0/2M0/2N0/2P0/4L0/4M0/4N0/4P0/4L2/4M2/4N2/4P2²

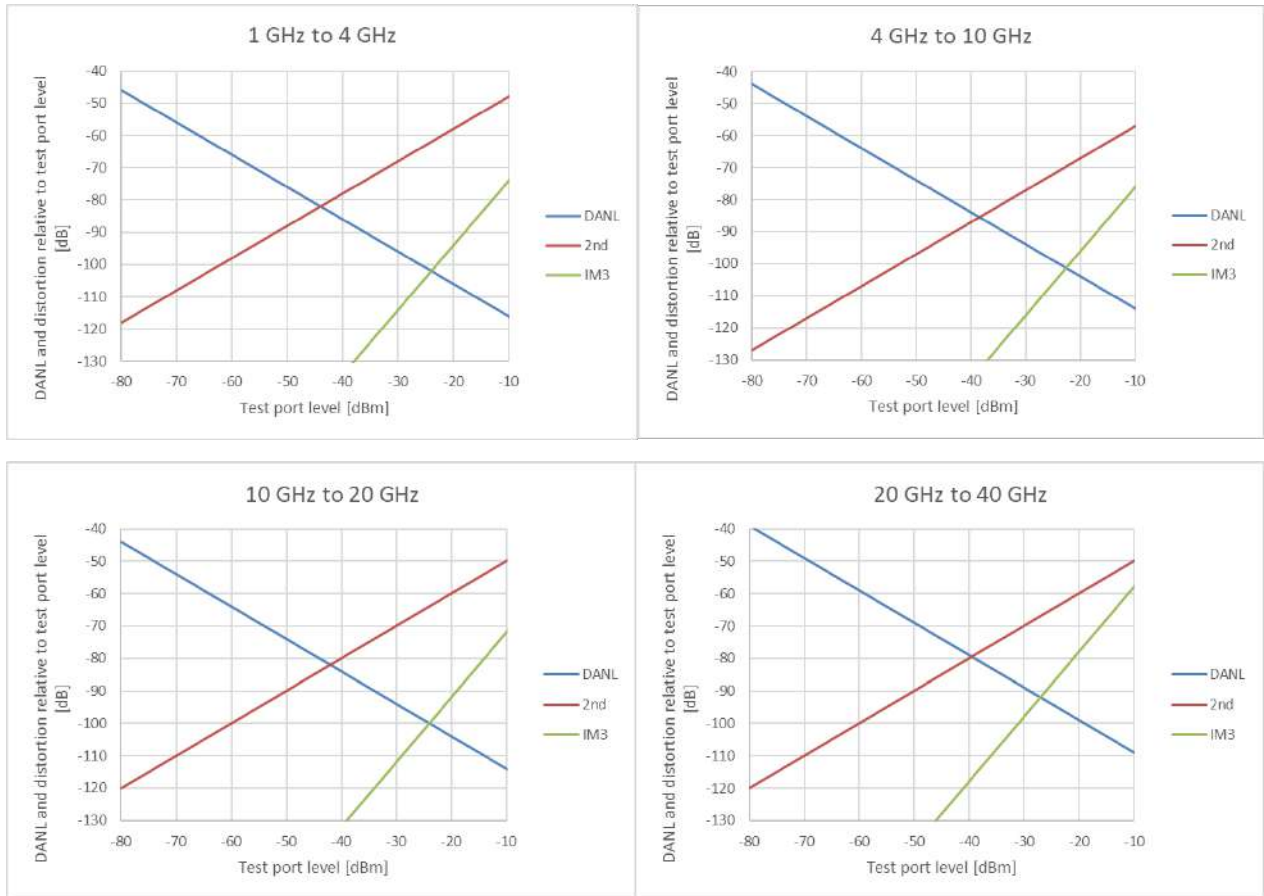

2. With High Attenuation. 2nd harmonic distortion applies up to 26.5 GHz.

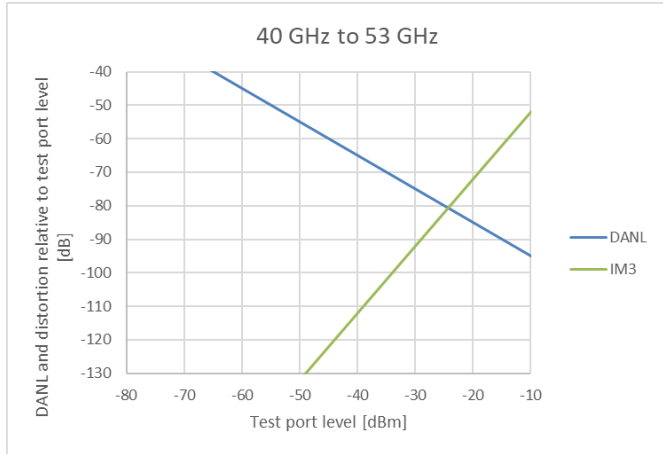

Table 42. Receiver Phase Noise (dBc/Hz)¹ – Typical

Description	1 kHz	10 kHz	100 kHz	1 MHz	10 MHz
CF = 1 GHz	-103	-103	-103	-128	-130
CF = 3 GHz	-96	-96	-96	-120	-130
CF = 10 GHz	-83	-83	-83	-116	-127
CF = 20 GHz ²	-76	-76	-76	-110	-121

1. At maximum specified power. Spurious signals are excluded. With the SA class, the phase noise of VNA's source is equivalent to the receiver phase noise.
2. Tested at 19.99 GHz.

Pulsed-RF Measurements (with Option 021/022 and S96025B/A)

This section provides specifications for the pulse modulation hardware (Option 021/022) on the E5080B ENA Series VNA. The S96025B/A Software is required to enable pulsed-RF measurement functions of the E5080B.

Table 43. Pulse Modulation On/Off Ratio (dB) – Typical

Option 240/260/290/2D0/2H0/2K0/440/460/490/4D0/4H0/4K0/442/462/492/4D2/4H2/4K2

Description	Normal Mode ¹	Fast Mode
9 kHz to 4.5 GHz	80	50
4.5 GHz to 15 GHz	70	40
15 GHz to 20 GHz	70	35

Option 2L0/2M0/2N0/2P0/4L0/4M0/4N0/4P0/4L2/4M2/4N2/4P2

Description	Normal Mode ¹	Fast Mode
100 kHz to 3 GHz	80	50
3 GHz to 8 GHz	80	40
8 GHz to 20 GHz	80	38
20 GHz to 40 GHz	70	30
40 GHz to 50 GHz	70	25

1. At power of > -20 dBm.

Pulse Modulation Shape Examples

Option 240/260/290/2D0/2H0/2K0/440/460/490/4D0/4H0/4K0/442/462/492/4D2/4H2/4K2

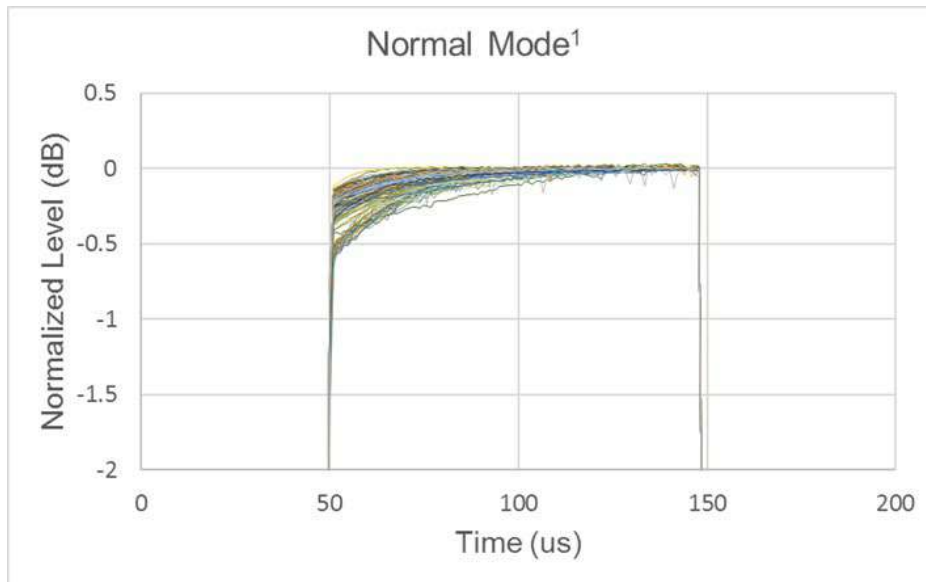

1. Measured with a 500 kHz IF bandwidth, no averaging (Average Type = Point). With 100 μ s pulse width setting. 50 μ s/div.

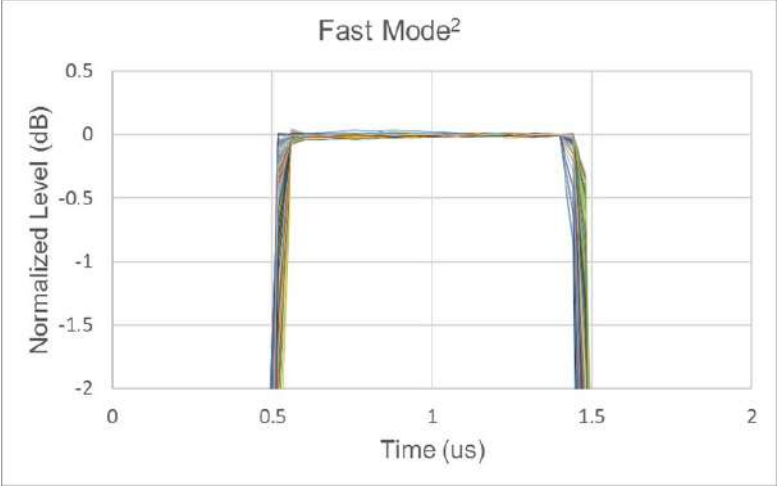

2. Measured with a 15 MHz IF bandwidth, averaging factor of 16 (Average Type = Point). With 1 μ s pulse width setting. 500 ns/div.

Option 2L0/2M0/2N0/2P0/4L0/4M0/4N0/4P0/4L2/4M2/4N2/4P2

1 GHz to 26.5 GHz

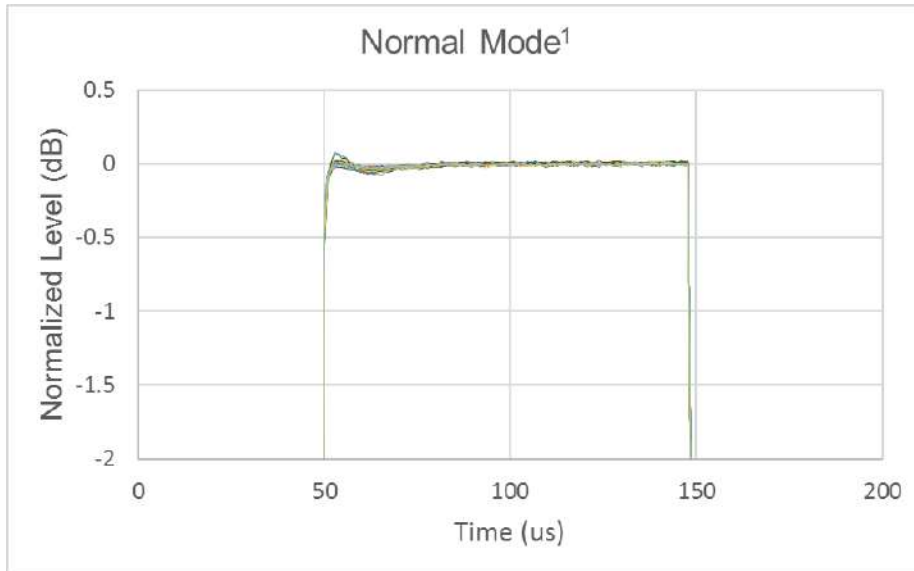

32 GHz

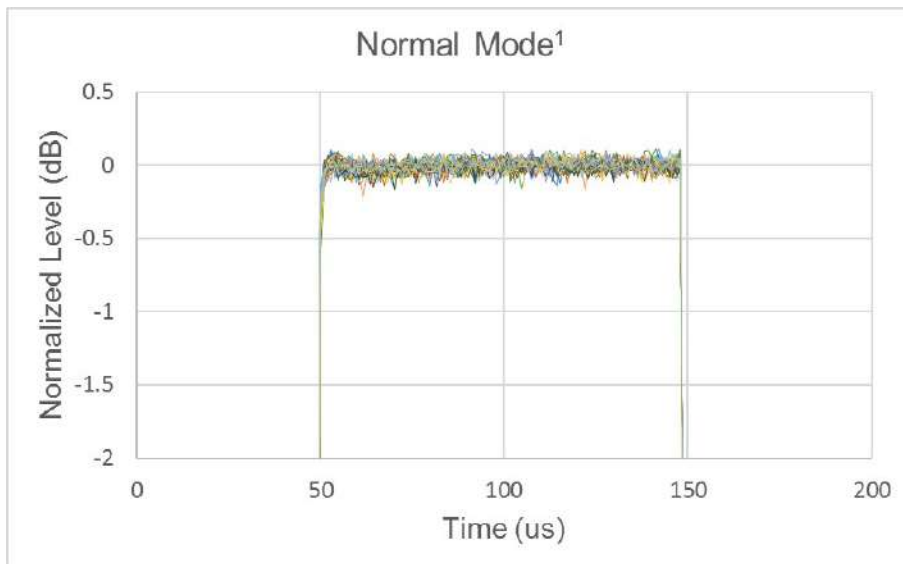

1. Measured with a 500 kHz IF bandwidth, averaging factor of 16 (Average Type = Point). With 100 μ s pulse width setting. 50 ns/div.

44 GHz

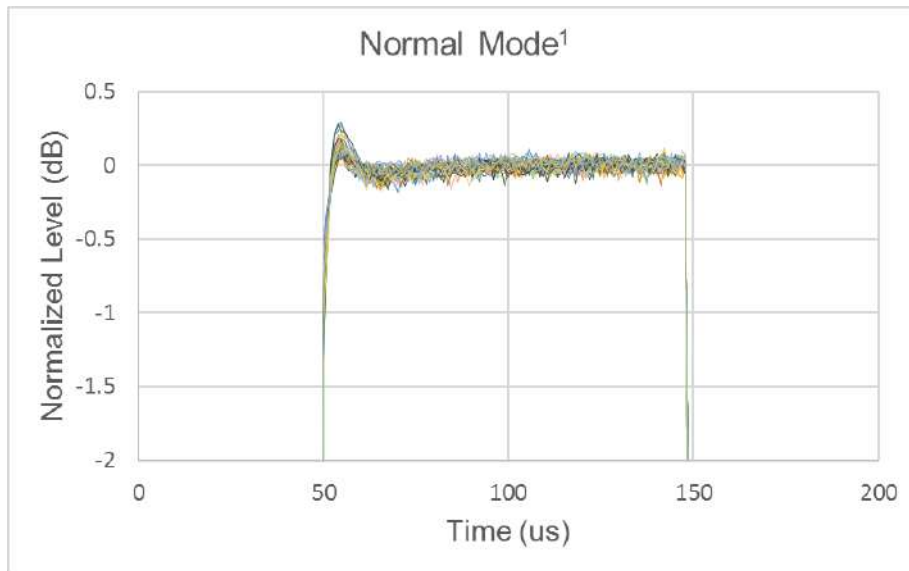

50 GHz

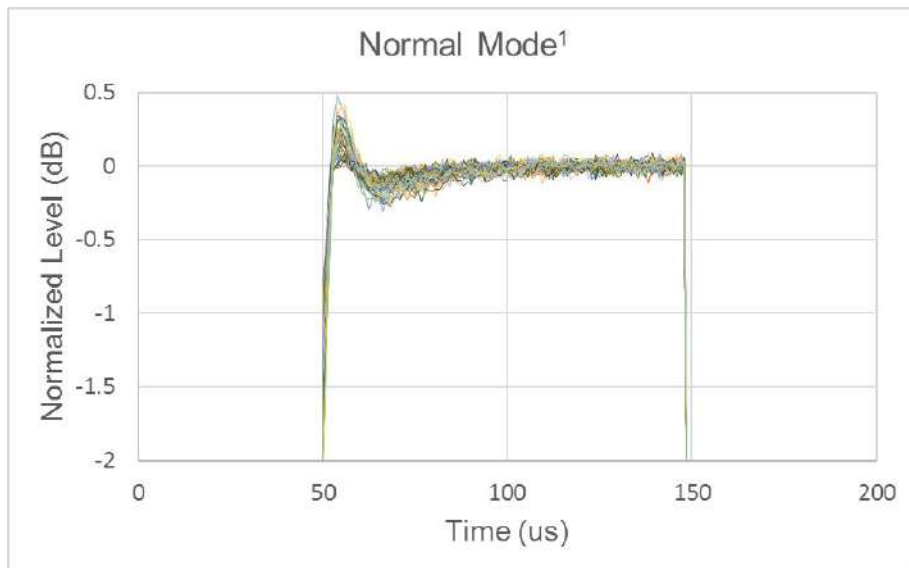

1. Measured with a 500 kHz IF bandwidth, averaging factor of 16 (Average Type = Point). With 100 μ s pulse width setting. 50 ns/div.

1 GHz to 26.5 GHz

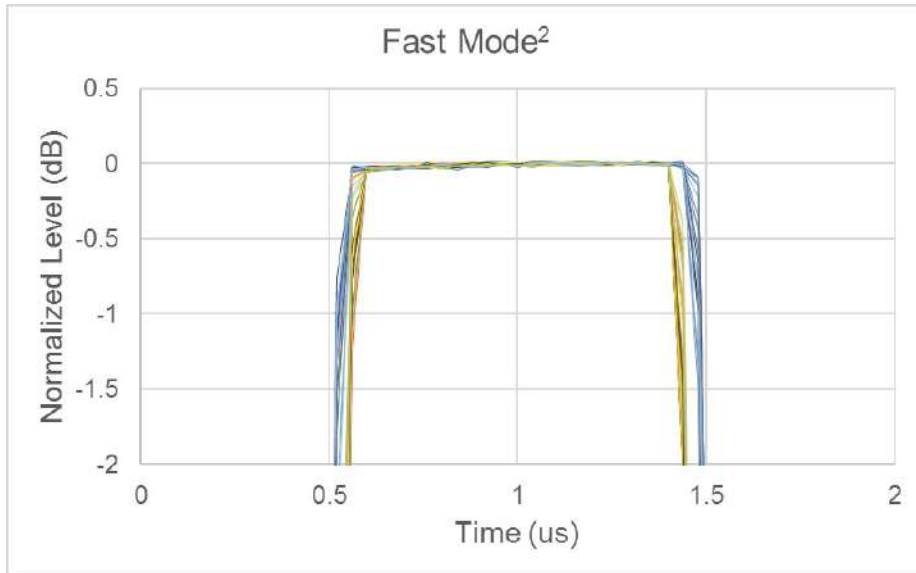

32 GHz

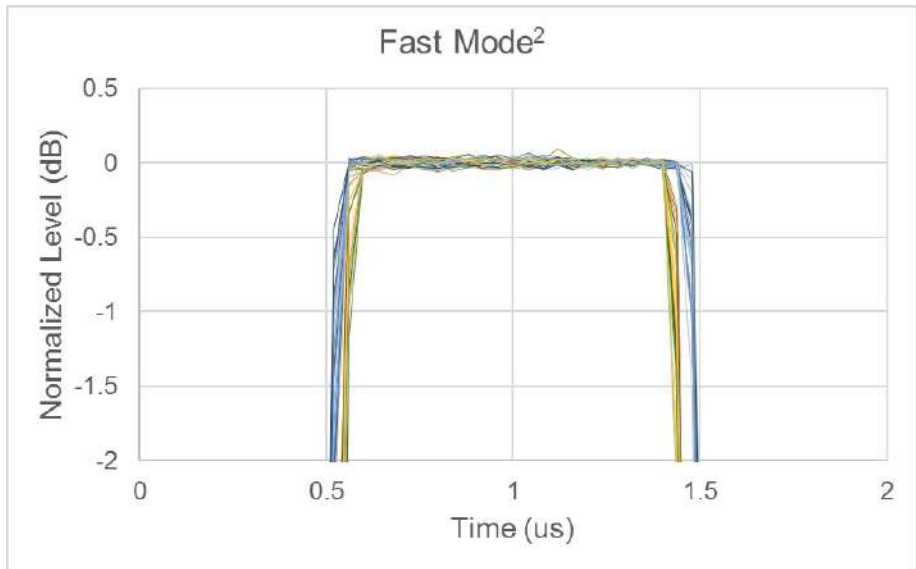

2. Measured with a 15 MHz IF bandwidth, averaging factor of 16 (Average Type = Point). With 1 μ s pulse width setting. 500 ns/div.

44 GHz

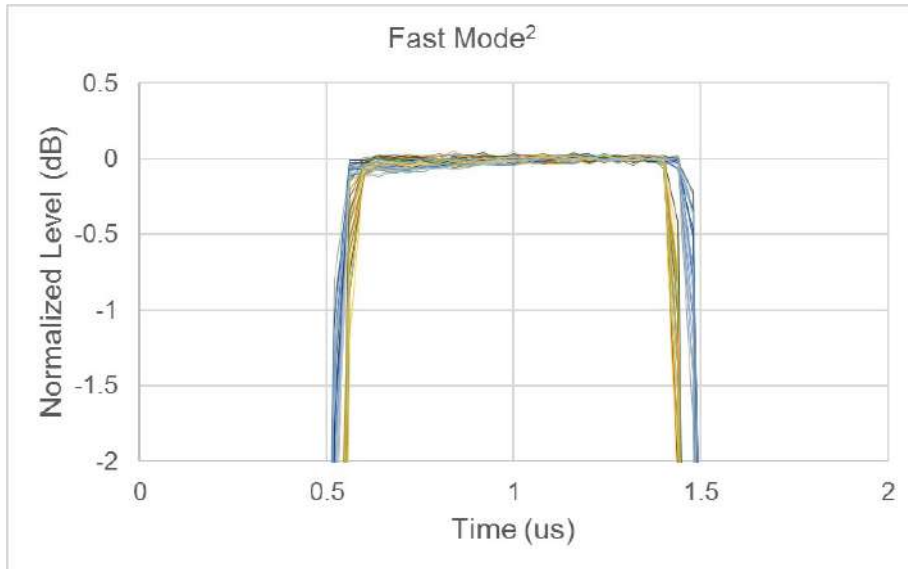

50 GHz

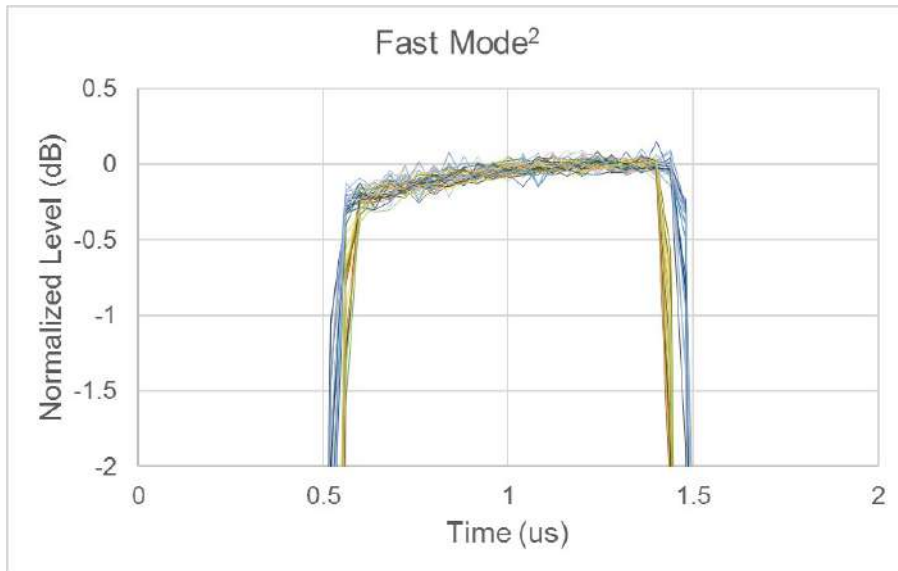

2. Measured with a 15 MHz IF bandwidth, averaging factor of 16 (Average Type = Point). With 1 μ s pulse width setting. 500 ns/div.

Table 44. Pulse Modulation (Source Modulators) – Typical

All options

Description	Typical
Minimum pulse width	200 ns
Minimum pulse period	1 μ s
Maximum pulse period	10 s

Enhanced Time Domain Analysis with TDR (with S96011B/A)

This section provides specifications for the enhanced time domain analysis on the E5080B ENA Series VNA. The S96011B/A Software is required to enable enhanced time domain analysis functions of the E5080B.

Table 45. Key Specifications of Enhanced Time Domain Analysis

Option 240/260/290/2D0/2H0/2K0/440/460/490/4D0/4H0/4K0/442/462/492/4D2/4H2/4K2

Description		Option 2K0/4K0/4K2	Option 2H0/4H0/4H2	Option 2D0/4D0/4D2	Option 290/490/492	Option 260/460/462	Option 240/440/442
Bandwidth	Spec.	20 GHz	18 GHz	14 GHz	9 GHz	6.5 GHz	4.5 GHz
Input impedance	Nom.	50 ohm					
DC damage level at test port	Spec.	35 V					
Maximum test port input voltage (Hot TDR mode)	Typ.	1.5 Vpp					
TDR stimulus ¹	Nom.	Step, Impulse					
TDR step amplitude ²	Nom.	1 mV to 5 V					
TDR step rise time ³ (min) (10% to 90%)	Spec.	22.3 ps	24.8 ps	31.9 ps	49.6 ps	68.6 ps	99.1 ps
TDR step response resolution in free space ⁴ ($\epsilon_r = 1$) (min)	Nom.	3.3 mm	3.7 mm	4.8 mm	7.4 mm	10.3 mm	14.9 mm
TDR impulse width (min) ³	Spec.	30.2 ps	33.6 ps	43.1 ps	67.1 ps	92.9 ps	135 ps
TDR deskew range (max) ⁵ (test cable length)	Typ.	50 ns	50 ns	50 ns	50 ns	50 ns	50 ns
DUT length (max) ⁶	Spec.	13.8 μ s	13.8 μ s	13.8 μ s	13.8 μ s	13.8 μ s	13.8 μ s
TDR stimulus repetition rate (max)	Spec.	19.9 MHz	17.9 MHz	13.9 MHz	8.9 MHz	6.4 MHz	4.4 MHz
RMS noise level ⁷	Typ.	60 μ Vrms	60 μ Vrms	60 μ Vrms	60 μ Vrms	60 μ Vrms	60 μ Vrms
Eye diagram data rate (max) ⁸	Spec.	16 Gb/s	14.4 Gb/s	11.2 Gb/s	7.2 Gb/s	5.2 Gb/s	3.6 Gb/s

1. The time domain function of the S96011B/A is similar to the time domain reflectometry (TDR) measurement on a TDR oscilloscope in that it displays the response in the time domain. In the TDR oscilloscope measurement, a pulse or step stimulus is input to the DUT and the change of the reflected wave over time is measured. In the S96011B/A TDR measurement, a sine wave stimulus is input to the DUT and the change of the reflected wave over frequency is measured. Then, the frequency domain response is transformed to the time domain using the Inverse Fourier Transform.
2. The TDR step amplitude setting does not vary the actual stimulus level input to the device but is used when calculating the Inverse Fourier Transform.
3. Minimum values may be limited by the DUT length setting.
4. To convert from rise time to response resolution, multiply the rise time by c , the speed of light in free space. To calculate the actual physical length, multiply this value in free space by v_f , the relative velocity of propagation in the transmission medium. (Most cables have a relative velocity of 0.66 for a polyethylene dielectric or 0.7 for a PTFE dielectric.)
5. Using high quality cables to connect the DUT is recommended in order to minimize measurement degradation. The cables should have low loss, low reflections, and minimum performance variation when flexed.
6. Maximum DUT length is the sum of the DUT and test cable lengths.
7. RMS noise level with 50 Ω DUT and default setup.
8. Maximum values may be limited by the DUT length setting.

Option 2L0/2M0/2N0/2P0/4L0/4M0/4N0/4P0/4L2/4M2/4N2/4P2

Description		Option 2P0/4P0/4P2	Option 2N0/4N0/4N2	Option 2M0/4M0/4M2	Option 2L0/4L0/4L2
Bandwidth	Spec.	53 GHz	44 GHz	32 GHz	26.5 GHz
Input impedance	Nom.	50 ohm			
DC damage level at test port	Spec.	35 V			
Maximum test port input voltage (Hot TDR mode)	Typ.	1.5 V (100 kHz to 20 GHz) 0.9 V (20 GHz to 30 GHz) 0.7 V (30 GHz to 40 GHz) 0.5 V (40 GHz to 53 GHz)	1.5 V (100 kHz to 20 GHz) 0.9 V (20 GHz to 30 GHz) 0.7 V (30 GHz to 40 GHz) 0.5 V (40 GHz to 44 GHz)	1.5 V (100 kHz to 20 GHz) 0.9 V (20 GHz to 30 GHz) 0.7 V (30 GHz to 32 GHz)	1.5 V (100 kHz to 20 GHz) 0.9 V (20 GHz to 26.5 GHz)
TDR stimulus ¹	Nom.	Step, Impulse			
TDR step amplitude ²	Nom.	1 mV to 5 V			
TDR step rise time ³ (min) (10% to 90%)	Spec.	8.42 ps	10.2 ps	14 ps	16.9 ps
TDR step response resolution in free space ⁴ ($\epsilon_r = 1$) (min)	Nom.	1.3 mm	1.5 mm	2.1 mm	2.5 mm
TDR impulse width (min) ³	Spec.	11.4 ps	13.8 ps	18.9 ps	22.8 ps
TDR deskew range (max) ⁵ (test cable length)	Typ.	50 ns	50 ns	50 ns	50 ns
DUT length (max) ⁶	Spec.	1.25 μ s	1.25 μ s	1.25 μ s	1.25 μ s
TDR stimulus repetition rate (max)	Spec.	52.9 MHz	43.9 MHz	31.9 MHz	26.4 MHz
RMS noise level ⁷	Typ.	120 μ Vrms	80 μ Vrms	80 μ Vrms	80 μ Vrms
Eye diagram data rate (max) ⁸	Spec	42.4 Gb/s	35.2 Gb/s	25.6 Gb/s	21.2 Gb/s

1. The time domain function of the S96011B/A is similar to the time domain reflectometry (TDR) measurement on a TDR oscilloscope in that it displays the response in the time domain. In the TDR oscilloscope measurement, a pulse or step stimulus is input to the DUT and the change of the reflected wave over time is measured. In the S96011B/A TDR measurement, a sine wave stimulus is input to the DUT and the change of the reflected wave over frequency is measured. Then, the frequency domain response is transformed to the time domain using the Inverse Fourier Transform.
2. The TDR step amplitude setting does not vary the actual stimulus level input to the device but is used when calculating the Inverse Fourier Transform.
3. Minimum values may be limited by the DUT length setting.
4. To convert from rise time to response resolution, multiply the rise time by c , the speed of light in free space. To calculate the actual physical length, multiply this value in free space by v_f , the relative velocity of propagation in the transmission medium. (Most cables have a relative velocity of 0.66 for a polyethylene dielectric or 0.7 for a PTFE dielectric.)
5. Using high quality cables to connect the DUT is recommended in order to minimize measurement degradation. The cables should have low loss, low reflections, and minimum performance variation when flexed.
6. Maximum DUT length is the sum of the DUT and test cable lengths.
7. RMS noise level with 50 Ω DUT and default setup.
8. Maximum values may be limited by the DUT length setting.

Impedance Analysis (with S96041B)

This section provides typical measurement accuracy for impedance analysis on the E5080B ENA with 16198A option 010 10 GHz test fixture. The 16198A option 010 is connected with the E5080B's options up to 20 GHz with either Type-N or 3.5-mm connectors. The S96041B Software is required to enable impedance analysis functions of the E5080B.

Impedance Measurement Accuracy – Typical¹

Option 240/260/290/2D0/2H0/2K0/440/460/490/4D0/4H0/4K0/442/462/492/4D2/4H2/4K2 (without bias tee options)

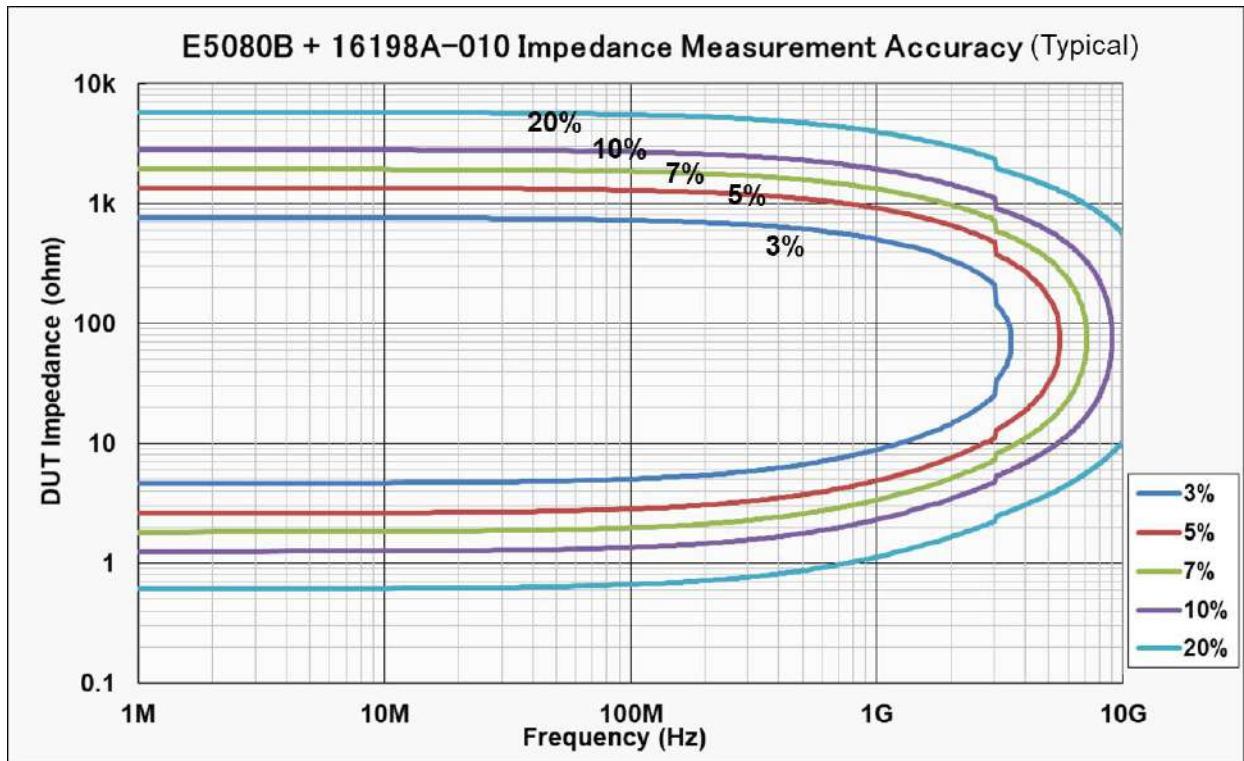

1. At source power of -18 to -16 dBm, ≤ 100 Hz IF bandwidth, without bias-tee options (option 120 or 140). Full 1-port calibration is performed with 85052DH02 cal kit at the 3.5-mm coaxial connector of 16198A-010's adapter, and open/short fixture compensation is performed on the 16198A-010's measurement surface. Typical performance is valid for calibration temperatures of $23^{\circ}\text{C} \pm 5^{\circ}\text{C}$ and $< 1^{\circ}\text{C}$ deviation from the calibration temperature.

General Information

Table 46. Miscellaneous Information

Description	Specification
System IF Bandwidth Range	1 Hz to 15 MHz
Number of points	1 to 100,003
Operating System	Windows 10 (Supports both 32-bit and 64-bit applications)

Table 47. Front Panel Information

Description	Specification
RF connectors	
Connector type	Type-N female (Option 240/260/290/440/460/490/442/462/492, 2D0/2H0/4D0/4H0/4D2/4H2 with option 1NC)
	3.5 mm male (Option 2D0/2H0/2K0/2L0/4D0/4H0/4K0/4L0/4D2/4H2/4K2/4L2)
	2.4 mm male (Option 2M0/2N0/4M0/4N0/4M2/4N2)
	1.85 mm male (Option 2P0/4P0/4P2)
Impedance	50 ohm (nominal)
USB Ports (4-ports)	
Standard	Compatible with USB 2.0
Connector	USB Type-A female
Display	
Size	31 cm (12.1 inch) diagonal color active matrix LCD with multi-touch screen
Resolution	1280 (horizontal) X 800 (vertical) resolution ¹

1. Valid pixels are 99.99% and more. Below 0.02% of fixed points of black, blue, green or red are not regarded as failure.

Table 48. Side Panel Information

Description	Specification
Display Output	DisplayPort and VGA (supports up to two simultaneous displays)
GPIB (Option 172)	24-pin D-Sub (Type D-24), female; compatible with IEEE-488
USB Ports	Four SuperSpeed USB ports, one USB device port ¹ .
LAN	Two Gigabit Ethernet, RJ-45 LAN ports.

1. USB Test and Measurement Class (TMC) interface that communicates over USB, complying with the IEEE 488.1 and IEEE 488.2 standards.

Table 49. Rear Panel Information

Description	Specification
External Trigger Input	
Connector	BNC female
Input level	Low threshold voltage: 0.5 V, High threshold voltage: 2.1 V Input level range: 0 to +5 V
Pulse width	$\geq 2 \mu\text{s}$
Polarity	Positive or negative
External Trigger Output / Meas Trig Ready Output	
Connector	BNC female
Maximum output current	50 mA
Output level	Low level voltage: 0 V, High level voltage: 5 V
Pulse width	1 μs (External Trigger Output only)
Polarity	Positive or negative
External Reference Input – Typical	
Connector	BNC female
Input frequency	10 MHz \pm 10 ppm
Input level	-3 to +10 dBm
Input impedance	50 Ω (nominal)
Internal Reference Output – Typical	
Connector	BNC female
Output frequency	10 MHz \pm 7 ppm
Output level	0 dBm \pm 3 dB into 50 Ω
Output impedance	50 Ω (nominal)
Internal Reference Signal Oven (Option 1E5) – Typical	
Connector	BNC female
Output frequency	10 MHz \pm 0.45 ppm
Output level	0 dBm minimum
Application I/O	
Connector	15-pin D-sub connector (female), Provides access to pulse modulators and generators
Device Test I/O	
Connector	25-pin D-sub connector (female), Provides serial and parallel digital signals for controlling device under test. Two independent 8-bit I/O
Power Supply (VIO1, VIO2)	
Output voltage	+0.9 to +3.5 V, 0.05 V step
Voltage accuracy	\pm 5%
Maximum output current	100 mA/group
Input Signal	
Input voltage range	0 V to VIO (V)
Minimum high-level input voltage	+2.0V (at VIO = +3.3 V), +1.17 V (at VIO = +1.8 V) +0.78 V (at VIO = +1.2 V)
Maximum low-level input voltage	+0.8 V (at VIO = +3.3 V), +0.63 V (at VIO = +1.8 V) +0.42 V (at VIO = +1.2 V)

Output Signal	
Minimum high-level output voltage	VIO – 0.1 V (at I _o = -100 μA)
Maximum low-level output voltage	+0.1 V (at I _o = 100 μA)
Bias Tee Inputs (Option 120 or 140) - Typical	
Connector	BNC female
Damage level	± 35 V, 500 mA DC (with internal resettable fuse)
Maximum bias current ¹	± 300 mA
Maximum bias voltage ¹	± 0 VDC at 9 kHz to 300 kHz
	± 10 VDC at 300 kHz to 1 MHz
	± 15 VDC at 1 MHz to 10 MHz
	± 20 VDC at 10 MHz to 20 GHz
	± 10 VDC at 300 kHz to 1 MHz
Handler I/O Port	
Connector	36-pin Centronics, female; provides connection to handler system
Line Power	
Frequency, voltage	50/60 Hz for 100 to 240 VAC
Maximum power	350 W
Typical power consumption ²	120 W (Option 240/260/290/2D0/2K0)
	145 W (Option 440/460/490/4D0/4K0)
	172 W (Option 442/462/492/4D2/4K2)
	129 W (Option 2L0/2M0/2N0/2P0)
	172 W (Option 4L0/4M0/4N0/4P0/4L2/4M2/4N2/4P2)

1. No degradation in RF specifications.
2. At preset.

Table 50. AUX Input and Output Information (Option 175)





Description	Specification	Typical
AUX Input		
Number of ports		4
Connector type		BNC female
Input voltage range		± 10 V
Damage voltage level		± 15 V
Accuracy ¹	1% ± 10 mV	
AUX Output		
Number of ports		2
Connector type		BNC female
Output voltage range		± 10 V
Output voltage resolution		5.4 mV
Output voltage accuracy ²	1% ± 20 mV	
Maximum output current	± 200 mA	

1. When IF Bandwidth is set to ≥ 300 kHz.
2. The specification does not meet when current overload occurs.

Table 51. Environmental and Physical Specifications



Description	Specification	
Descriptions	Samples of this product have been type tested in accordance with the Keysight Environmental Test Manual and verified to be robust against the environmental stresses of Storage, Transportation and End-use; those stresses include, but are not limited to, temperature, humidity, shock, vibration, altitude, and power line conditions. Test Methods are aligned with IEC 60068-2 and levels are similar to MIL-PRF-28800F Class 3.	
Temperature	Operating	0 to 40 °C ambient
	Non-operating	-10 to 60 °C
Humidity	Operating	Type tested at 20 to 80%, wet bulb temperature < 29 °C (non-condensing)
	Non-operating	Type tested at 20 to 90 %, wet bulb temperature < 40 °C (non-condensing)
Altitude	Operating	Up to 2,000 meters (6,561 feet)
	Non-operating	Up to 4,572 meters (15,000 feet)
Vibration	Operating	0.21 G maximum, 5 Hz to 500 Hz
	Non-operating	0.5 G maximum, 5 Hz to 500 Hz
Instrument protection	IP 30 IEC/EN 60529	
Instrument calibration cycle	1 year	

Table 52. Regulatory and Safety Compliance

EMC ¹	
Complies with the essential requirements of the European EMC Directive as well as current editions of the following standards (dates and editions are cited in the Declaration of Conformity).	
	<p>The CE mark is a registered trademark of the European Community (if accompanied by a year, it is the year when the design was proven). This product complies with all relevant directives.</p> <ul style="list-style-type: none"> • IEC 61326-1 • CISPR 11 Group 1, Class A
	UK conformity mark is a UK government owned mark. When affixed to the product is declaring all applicable Directives and Regulations have been met in full.
CAN ICES/NMB-001(A)	This ISM device complies with Canadian ICES-001. Cet appareil ISM est conforme a la norme NMB du Canada.
	<p>The RCM mark is a registered trademark of the Australian Communications and Media Authority.</p> <ul style="list-style-type: none"> • AS/NZS CISPR 11
	<p>South Korean Certification (KC) mark; includes the marking's identifier code: R-R-Kst-xxxxxxx</p> <p>South Korean Class A EMC declaration: Information to the user: This equipment has been conformity assessed for use in business environments. In a residential environment this equipment may cause radio interference. ※ This EMC statement applies to the equipment only for use in business environment.</p> <div style="border: 1px solid black; padding: 5px; margin-top: 10px;"> <p style="text-align: center; background-color: #d9e1f2;">사 용 자 안 내 문</p> <p style="color: blue;">이 기기는 업무용 환경에서 사용할 목적으로 적합성평가를 받은 기기로서 가정용 환경에서 사용하는 경우 전파간섭의 우려가 있습니다.</p> </div> <p>※ 사용자 안내문은 “업무용 방송통신기자재”에만 적용한다.</p>

Safety¹

Complies with the essential requirements of the European Low Voltage Directive as well as current editions of the following standards (dates and editions are cited in the Declaration of Conformity). This product is designed for use in INSTALLATION CATEGORY II and POLLUTION DEGREE 2 and MEASUREMENT CATEGORY NONE per IEC standards. This product is intended for indoor use.

	<ul style="list-style-type: none"> • IEC/EN 61010-1
	<p>The CSA mark is a registered trademark of the CSA International.</p> <ul style="list-style-type: none"> • Canada: CSA C22.2 No. 610610-1 • USA: UL std no. 61010-1

1. To find a current **Declaration of Conformity** for a specific Keysight product, go to: <http://www.keysight.com/go/conformity>.

Table 53. Physical Size and Weight

Description	Characteristic	Note
Weight	Option 240/260/290/2D0/2H0/2K0/2L0/2M0/2N0/2P0: 14 kg Option 440/460/490/4D0/4H0/4K0/4L0/4M0/4N0/4P0/ 442/462/492/4D2/4H2/4K2/4L2/4M2/4N2/4P2: 15 kg	Without handles

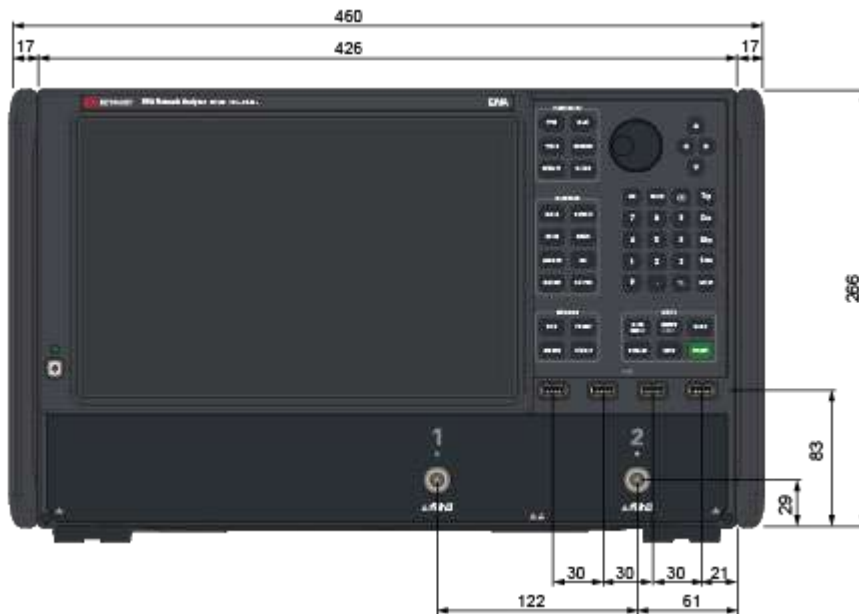

Dimensions (front view, E5080B with option 240/260/290, 2D0/2H0 + option 1NC (Type-N), in millimeters)

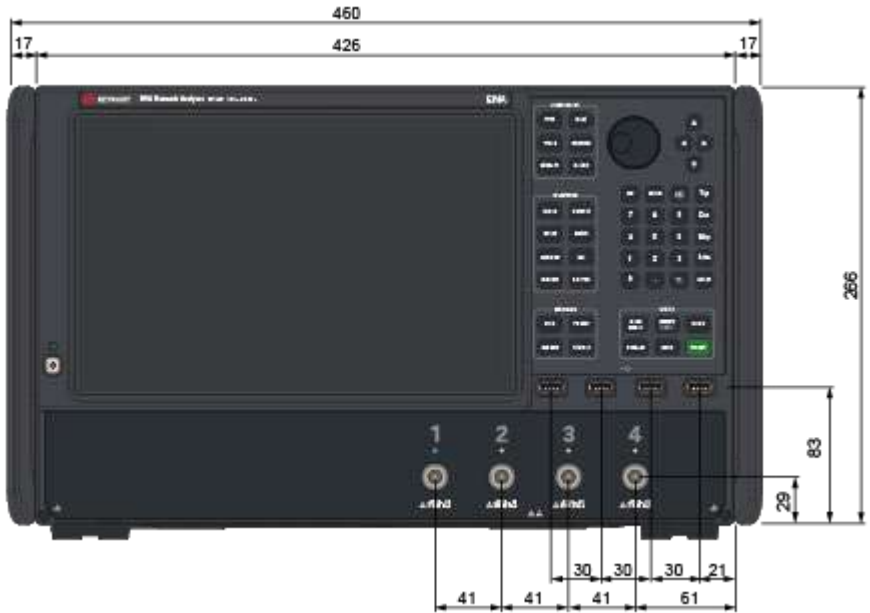

Dimensions (front view, E5080B with option 440/460/490/442/462/492, 4D0/4H0/4D2/4H2 + option 1NC (Type-N), in millimeters)

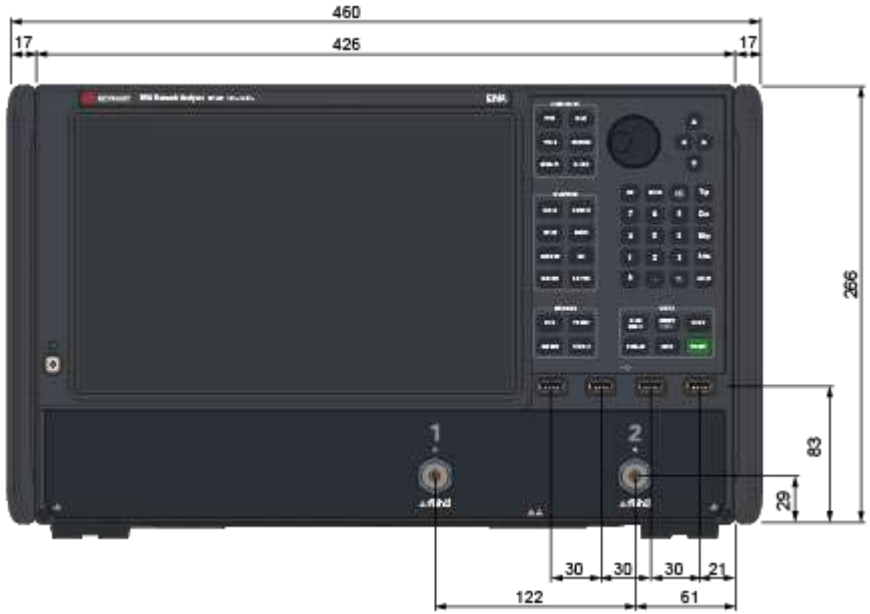

Dimensions (front view, E5080B with option 2D0/2H0/2K0/2L0 (3.5 mm), in millimeters)

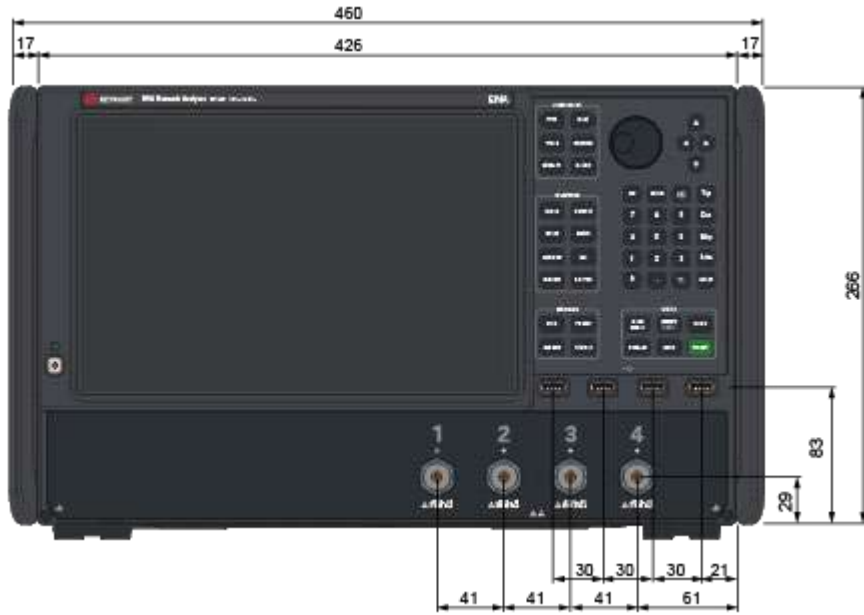

Dimensions (front view, E5080B with option 4D0/4H0/4K0/4L0/4D2/4H2/4K2/4L2 (3.5 mm), in millimeters)

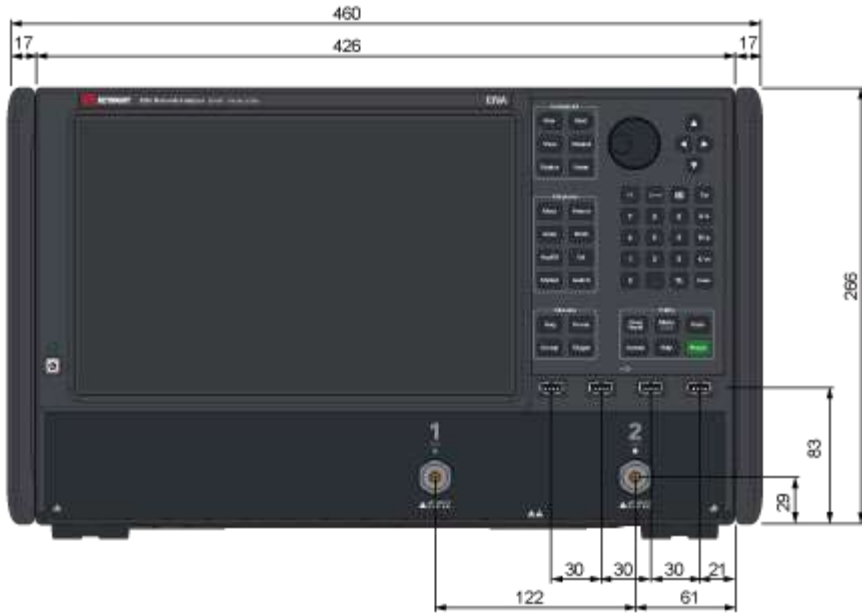

Dimensions (front view, E5080B with option 2M0/2N0 (2.4 mm), in millimeters)

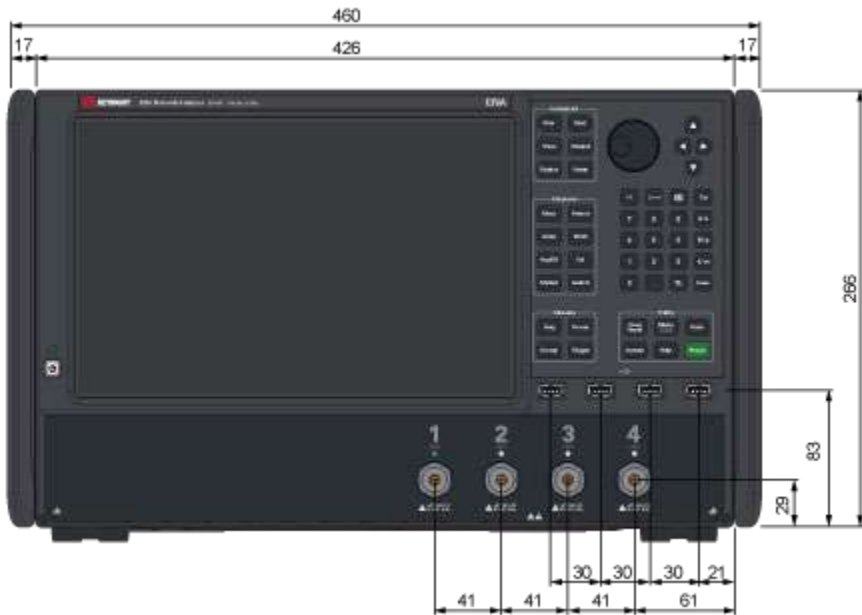

Dimensions (front view, E5080B with option 4M0/4N0/4M2/4N2 (2.4 mm), in millimeters)

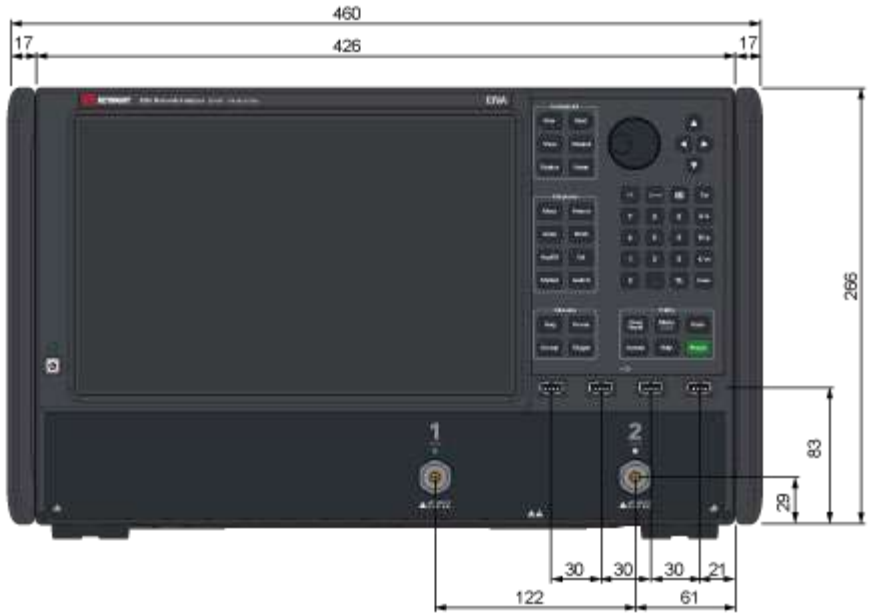

Dimensions (front view, E5080B with option 2P0 (1.85 mm), in millimeters)

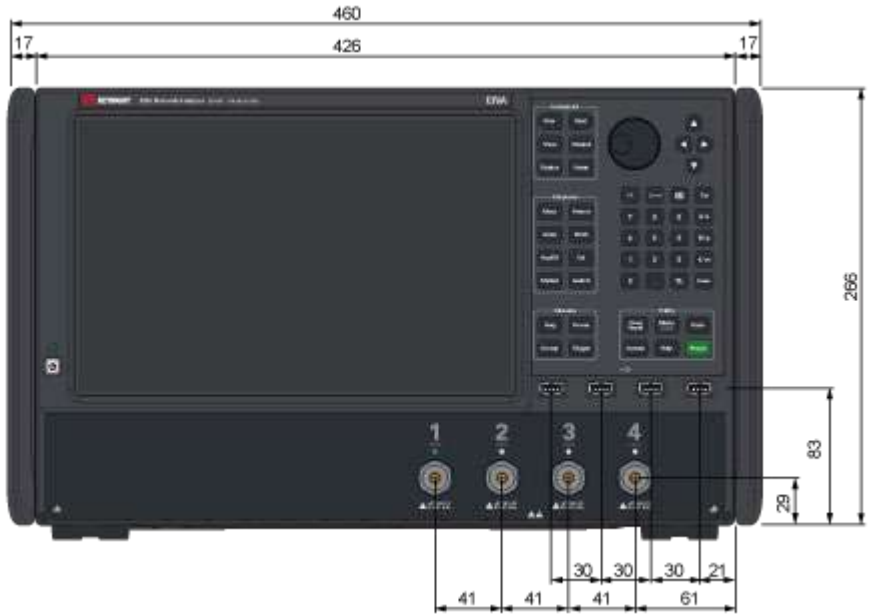

Dimensions (front view, E5080B with option 4P0/4P2 (1.85 mm), in millimeters)

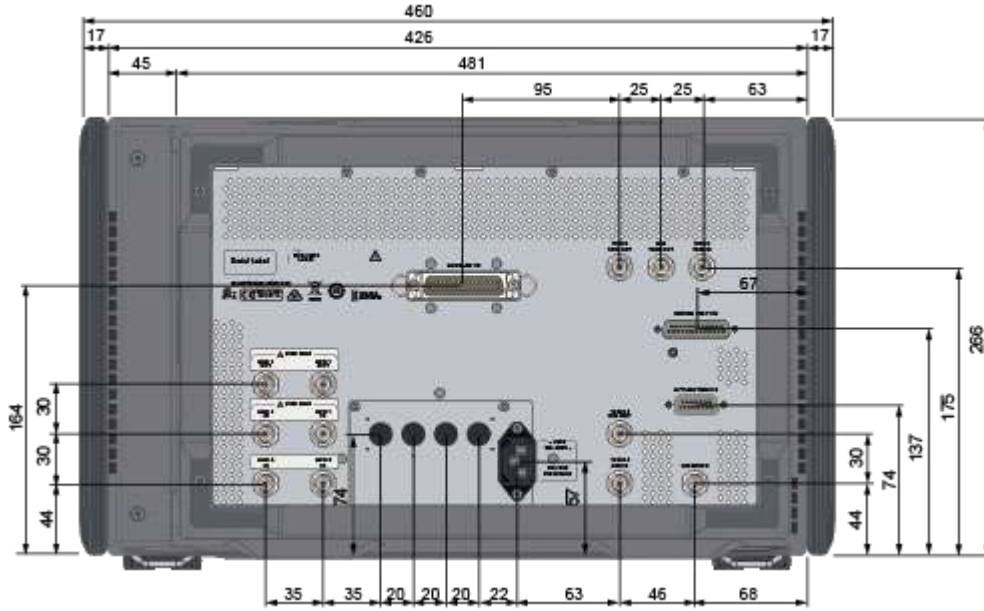

Dimensions (rear view, E5080B with option 1E5/175, in millimeters)

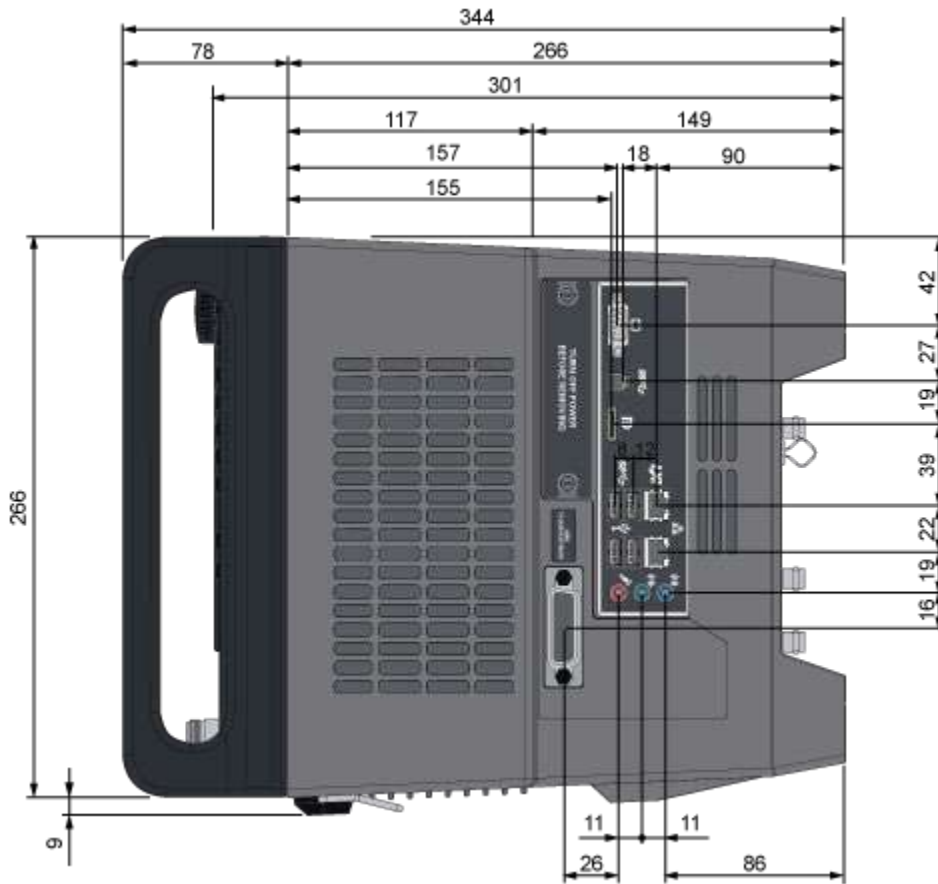

Dimensions (side view, E5080B with option 172 in millimeters)

Measurement Throughput Summary

Table 54. Cycle Time for Measurement Completion (milliseconds)¹

Option 240/260/290/2D0/2H0/2K0/440/460/490/4D0/4H0/4K0 - Typical

Description	Sweep Mode: Auto			Sweep Mode: Stepped		
10 MHz – 9 GHz Frequency Span, 1 MHz IF Bandwidth						
Number of points	201	401	1601	201	401	1601
Uncorrected	3.8	4.8	7.9	3.7	5.3	11.7
2-port Calibration	6.4	8.7	14.9	6.4	9.5	22.3
4-port Calibration	11.9	16.3	28.7	11.9	18.0	43.5
10 MHz – 20 GHz Frequency Span, 1 MHz IF Bandwidth						
Number of points	201	401	1601	201	401	1601
Uncorrected	4.4	6.0	8.5	4.4	6.0	14.7
2-port Calibration	7.8	11.1	16.0	7.8	11.1	28.5
4-port Calibration	14.7	21.2	31.0	14.5	21.1	55.8
800 MHz – 1 GHz Frequency Span, 1 MHz IF Bandwidth						
Number of points	201	401	1601	201	401	1601
Uncorrected	1.7	2.1	4.2	2.0	2.6	5.0
2-port Calibration	2.4	3.1	7.4	3.1	4.2	9.0
4-port Calibration	4.0	5.5	14.5	5.2	7.5	17.0
9 GHz – 10 GHz Frequency Span, 1 MHz IF Bandwidth						
Number of points	201	401	1601	201	401	1601
Uncorrected	1.7	2.1	4.2	1.7	2.1	4.2
2-port Calibration	2.4	3.1	7.4	3.6	5.1	12.6
4-port Calibration	4.0	5.5	14.0	6.1	9.3	24.1

Option 2L0/2M0/2N0/2P0/4L0/4M0/4N0/4P0 - Typical

Description	Sweep Mode: Auto			Sweep Mode: Stepped		
9 GHz – 10 GHz Frequency Span, 1 MHz IF Bandwidth						
Number of points	201	401	1601	201	401	1601
Uncorrected	2.0	2.5	6.1	2.2	3.0	6.7
2-port Calibration	2.8	4.0	11.2	3.5	5.0	12.4
4-port Calibration	4.9	7.4	21.7	6.2	9.4	24.2
10 MHz – 26.5 GHz Frequency Span, 1 MHz IF Bandwidth						
Number of points	201	401	1601	201	401	1601
Uncorrected	4.9	6.7	9.9	4.9	6.7	16.2
2-port Calibration	8.8	12.3	18.8	8.8	12.3	31.0
4-port Calibration	17.9	24.9	38.1	17.9	24.9	62.2
10 MHz – 40 GHz Frequency Span, 1 MHz IF Bandwidth						
Number of points	201	401	1601	201	401	1601
Uncorrected	5.3	7.3	12.0	5.3	7.3	17.2
2-port Calibration	9.5	13.5	23.1	9.5	13.5	33.4
4-port Calibration	19.8	27.8	47.0	19.9	27.8	67.3
10 MHz – 53 GHz Frequency Span, 1 MHz IF Bandwidth						
Number of points	201	401	1601	201	401	1601
Uncorrected	5.7	7.7	14.8	5.7	7.7	18.3
2-port Calibration	10.3	14.3	28.5	10.3	14.3	35.6
4-port Calibration	21.9	30.0	58.1	21.8	30.1	72.3

1. Analyzer display turned off with DISPlay:VISible OFF. Measured with firmware revision A.14.10.03. Data for one trace (S11) measurement. Uncorrected measurements are for one sweep direction. 2-port calibration is measured with a 2-port option. 4-port calibration is measured with a 4-port option.

Table 55. Data Transfer Time, All Options¹ – Typical

Number of points	201	401	1601
SCPI over GPIB²			
64-bit floating point	7.9	14	52
32-bit floating point	4.8	8.0	27
ASCII	19	37	144
SCPI over 1 Gbps LAN (Socket)²			
REAL 64	0.8	0.9	1.5
REAL 32	1.0	0.8	1.1
ASCII	12	24	94
SCPI over 1 Gbps (HiSLIP)²			
REAL 64	1.3	1.3	2.0
REAL 32	1.3	1.4	1.8
ASCII	3.4	5.2	14.8
SCPI over USB (SICL-USB)²			
REAL 64	1.7	1.9	2.3
REAL 32	1.6	1.7	2.1
ASCII	1.7	2.6	9.3
SCPI over GPIB/USB (82357B)			
REAL 64	11	18	53
REAL 32	8.6	12	30
ASCII	140	281	1125

1. Data transfer time varies depending on the type of PC and control software.
2. Transferred LogMag S11 data using :CALC:MEAS:DATA:FDAT?

E5080B Test Set Block Diagrams

Legend

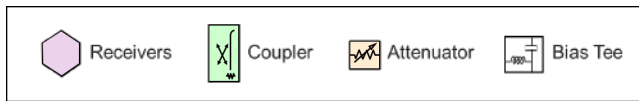

E5080B Option 240/260/290/2D0/2K0 (2-port base options)

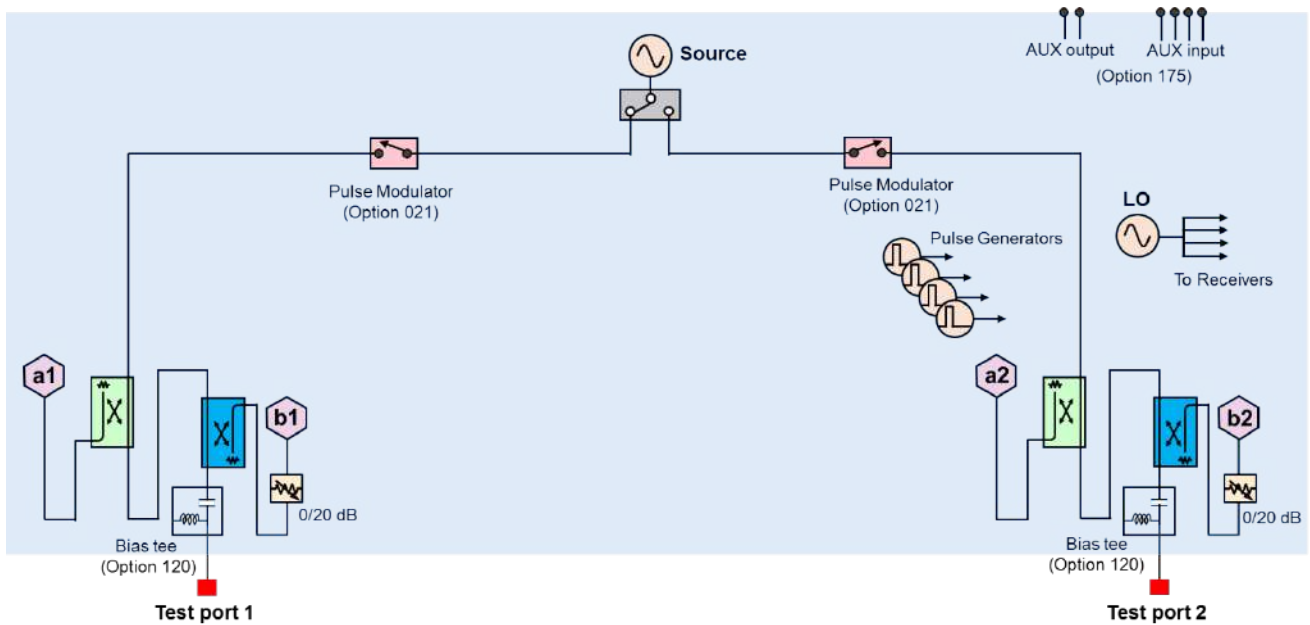

E5080B Option 2L0/2M0/2N0/2P0 (2-port base options)

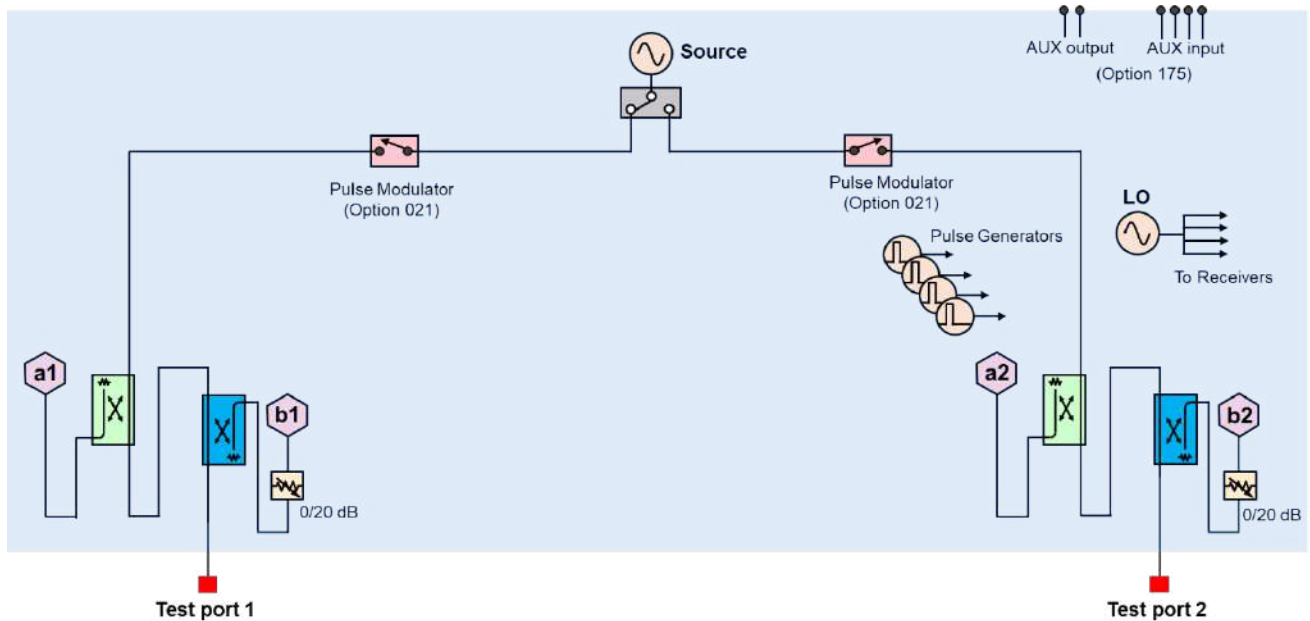

E5080B Option 440/460/490/4D0/4K0 (4-port base options)

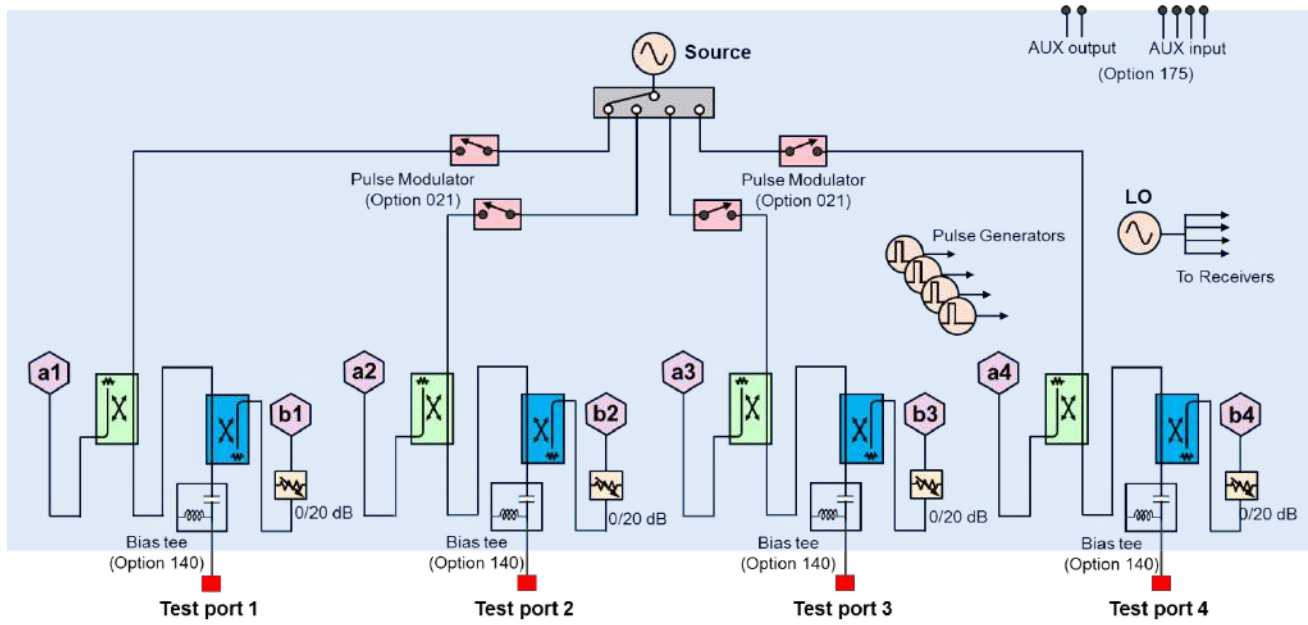

E5080B Option 4L0/4M0/4N0/4P0 (4-port base options)

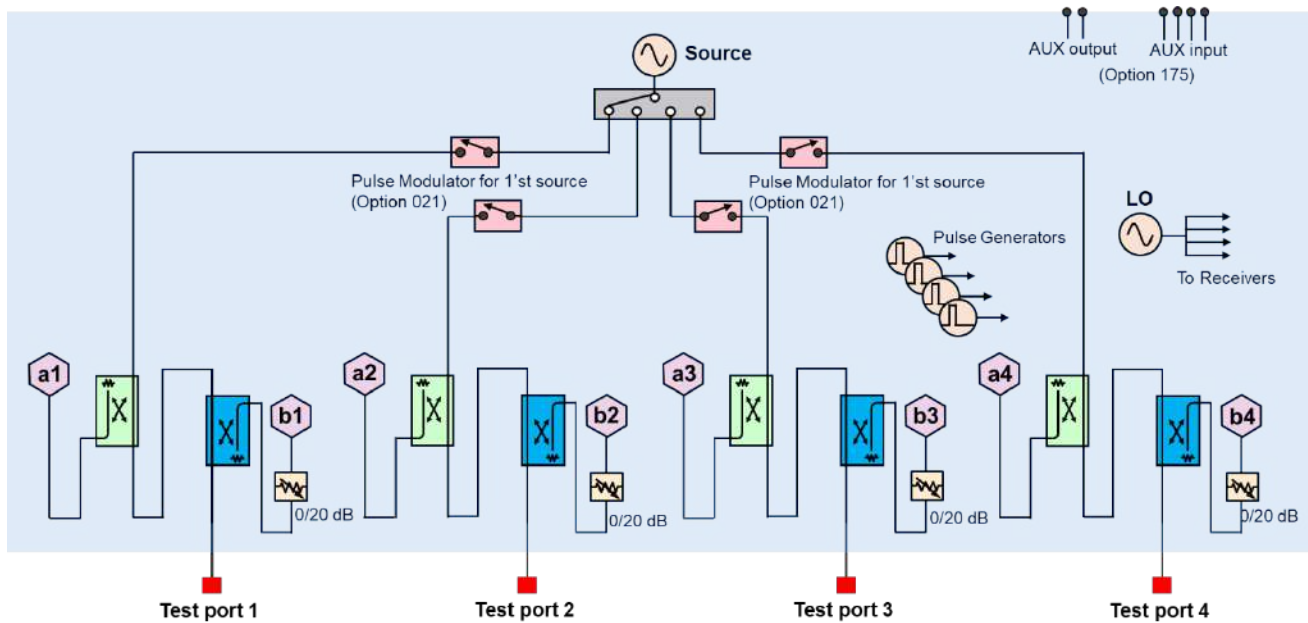

E5080B Option 442/462/492/4D2/4K2 (4-port second source option)

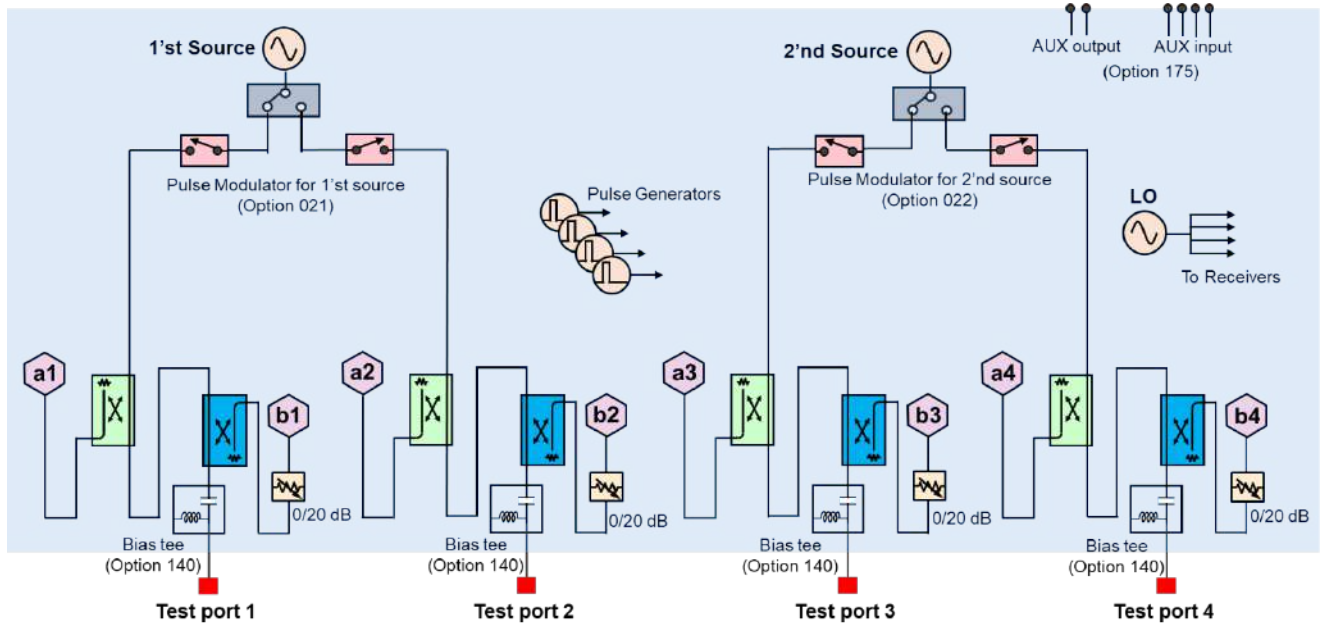

E5080B Option 4L2/4M2/4N2/4P2 (4-port second source options)

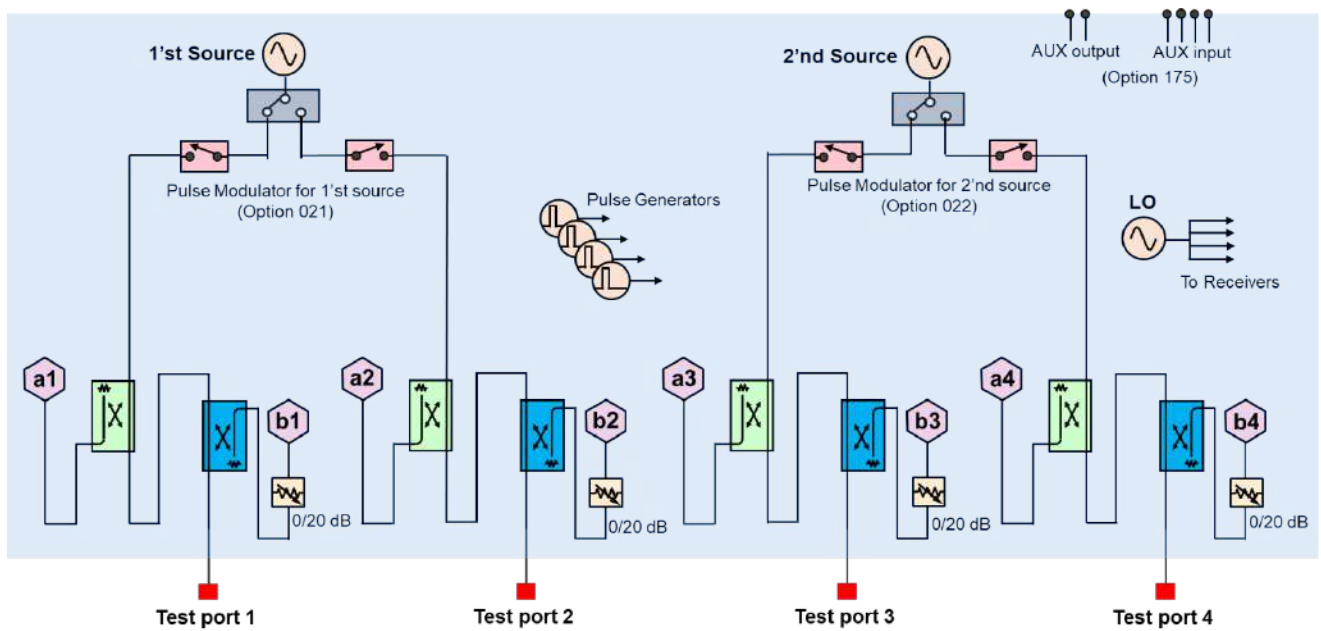

E5092A Configurable Multiport Test Set

This section provides specifications of the E5092A configurable multiport test set. Regulatory and safety compliance for E5092A is same as E5080B (Table 52).

Table 56. Test Set Input/output Performance

Description	Specification	Typical
Frequency range	50 MHz to 20 GHz	
Damage level	-	20 dBm, \pm 35 VDC

Table 57. Port Performance – Specification

Description	SPDT Switch ¹	SP4T Switch ²
Load Match (selected port, dB)		
50 MHz to 2 GHz	17	17
2 GHz to 3 GHz	11	11
3 GHz to 4 GHz	11	8
4 GHz to 8 GHz	8	8
8 GHz to 10 GHz	7	7
10 GHz to 18 GHz	4	4
18 GHz to 20 GHz	4	4
Load Match (unselected port, dB)		
50 MHz to 3 GHz	17	17
3 GHz to 10 GHz	11	11
10 GHz to 16 GHz	8	8
16 GHz to 18 GHz	6	6
18 GHz to 20 GHz	4	4
Load Match (common port, dB)		
50 MHz to 1.3 GHz	16	16
1.3 GHz to 2 GHz	16	11
2 GHz to 4 GHz	11	11
4 GHz to 8 GHz	8	8
8 GHz to 10 GHz	7	7
10 GHz to 20 GHz	4	4
Insertion Loss (dB)		
50 MHz to 100 MHz	4	4
100 MHz to 2 GHz	3.5	3.5
2 GHz to 3 GHz	4.5	4.5
3 GHz to 4 GHz	5	5.5
4 GHz to 6 GHz	5.5	6
6 GHz to 8 GHz	7	7.5
8 GHz to 10 GHz	8	8.5
10 GHz to 14 GHz	8.5	9.5
14 GHz to 18 GHz	10	10.5
18 GHz to 20 GHz	11.5	12

1. SPDT: Single-pole-double-through switches.
2. SP4T: Single-pole-four-throw switches.

Description	SPD	SPD
Stability per Switch (dB/°C)		
50 MHz to 4 GHz	0.003 ¹	0.007 ²
4 GHz to 12 GHz	0.005 ¹	0.012 ²
12 GHz to 20 GHz	0.008 ¹	0.017 ²

1. Environment temperature +23 °C± 3 °C and internal DC source: ≤ 100 mA (Sum of 4 channels), no heat source and no wall close to the unit.
2. Besides the above condition.

Description	Specification
Isolation (dB)¹	
50 MHz to 500 MHz	65
500 MHz to 1 GHz	80
1 GHz to 2 GHz	85
2 GHz to 6 GHz	90
6 GHz to 10 GHz	85
10 GHz to 18 GHz	75
18 GHz to 20 GHz	65 ²

1. This specification is defined when all ports are terminated with a 50-ohm load.
2. Over arbitrary test ports.

Table 58. Control Line

Description	Specification	Typical
Number of groups	4 Group A: 8 bits Group B, C, D: 4 bits	
Input voltage range ¹	0 to +5 V (positive input) -5 to 0 V (negative input)	
Maximum current	Group A, B: 50 mA in total of each group Group C, D: 500 μA in total of each group	
Impedance		Group A, B: < 10 Ω, Group C, D: < 200 Ω

1. Input voltage will be clipped at about ± 5.2 V when over this range.

Table 59. DC Source

Description	Specification	Typical
Number of sources	4	
Output voltage range ¹		0 to +5.2 V (nominal) ¹
Output voltage accuracy	± 3% of setting (+1 V to +5 V) at 1 M ohm load impedance	
Voltage resolution		10 mV (nominal) ²
Maximum current	150 mA for each source	
Output impedance		< 5 Ω

1. The output voltage can be set in this range.
2. The output voltage resolution becomes effective between 0 V to 5.2 V.

Table 60. Storage Environment

Description	Typical	
Temperature	Operating	+5 to +40 °C ambient
	Non-operating	-10 to 60 °C
Humidity	Operating	20 to 80 % at wet bulb temperature < +29 °C (non-condensing)
	Non-operating	20 to 90% at wet bulb temperature < +40 °C (non-condensing)
Altitude	Operating	0 to 2,000 meters (6,561 feet)
	Non-operating	0 to 4,572 meters (15,000 feet)
Vibration	Operating	0.21 G maximum, 5 Hz to 500 Hz
	Non-operating	0.5 G maximum, 5 Hz to 500 Hz

Table 61. Front Panel Information

Description	Typical
Connector	SMA female
Test ports	38 ports
Control line	15-pin D-sub female 25-pin D-sub female

Table 62. Rear Panel Information

Description	Typical
USB port	Type B-receptacle, provide connection to the E5080B
Line Power	
Frequency	47 to 63 Hz
Voltage	90 to 132 VAC, or 198 to 264 VAC (automatically switched)
VA max	300 VA maximum

Table 63. Physical Size and Weight

Description	Typical
Weight	9 kg

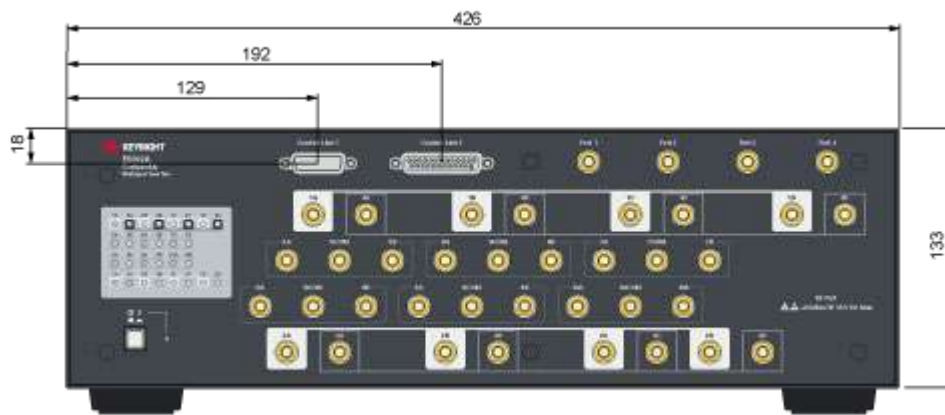

Dimensions (front view, E5092A with option 020, in millimeters)

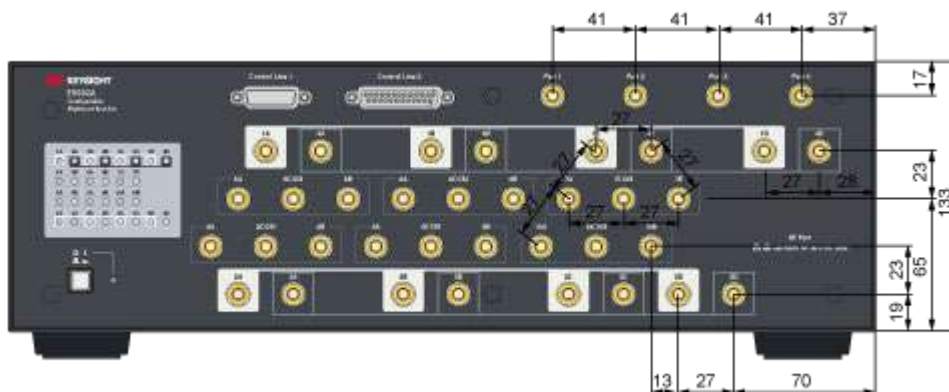

Dimensions (pitch between switches, E5092A with option 020, in millimeters)

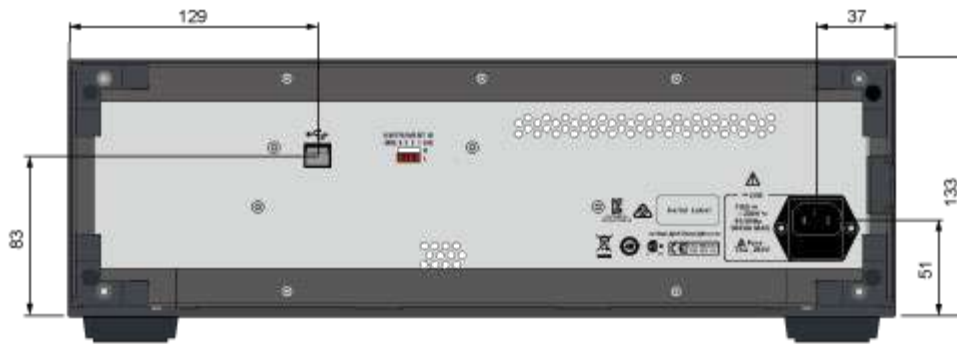

Dimensions (rear view, E5092A with option 020, in millimeters)

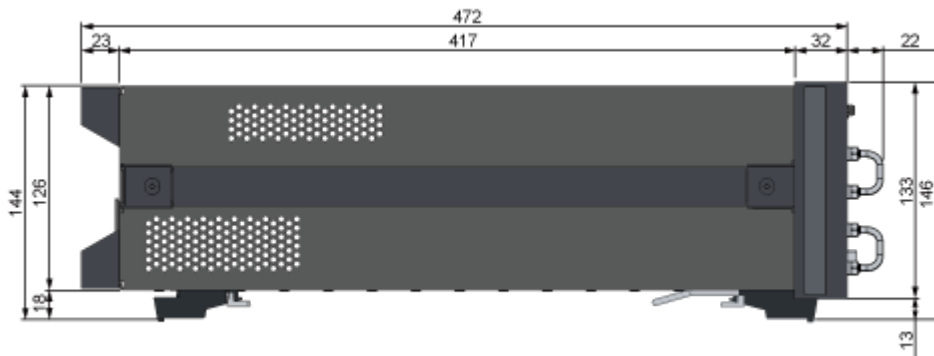

Dimensions (side view, E5092A with option 020, in millimeters)

Literature Information

- Keysight E5080B ENA Series Vector Network Analyzer – Configuration Guide, [5992-3842EN](#)
- 10 GHz Impedance Measurement on E5080B – Solution Brief, [3122-1166](#)
- Keysight E5071C to E5080B Code Migration Guide, [5992-3873EN](#)
- Keysight Network Analyzer – Selection Guide, [5989-7603EN](#)
- Electronic Calibration (ECal) Modules for Network Analyzer – Technical Overview, [5963-3743E](#)
- Drive Down the Cost of Test Using the ENA – Application Note, [5992-0195EN](#)

Web Resources

- www.keysight.com/find/ena
- www.keysight.com/find/na
- www.keysight.com/find/vnasoftware
- www.keysight.com/find/ecal

Learn more at: www.keysight.com

For more information on Keysight Technologies' products, applications or services, please contact your local Keysight office. The complete list is available at: www.keysight.com/find/contactus

